



2022

 profil+tec
positive profile



01_
Floor covering profiles

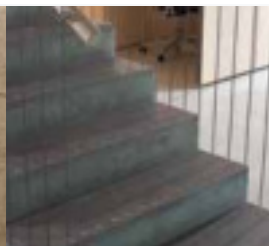

02_
Stair nosing profiles



03_
Wall covering profiles



04_
Joints



05_
Perimeter profiles for
terraces



06_
Membranes



07_
Baseboard

profil+tec



Index



08_
Drainage systems

09_
DIY profiles

10_
Tile installation
accessories

Floor covering profiles page 5

Floor covering Stair nosing pag. 43

Floor covering Wall coveringpag. 65

Joints pag. 107

Perimeter profiles for
balconies and terraces pag. 127

Membranes pag. 143

Baseboard pag. 149

Drainage systems pag. 161

DIY profiles pag. 177

Tile installation accessories pag. 183

Marketing pag. 195

01_

02_

03_

04_

05_

06_

07_

08_

09_

10_

///_





Floor covering profiles

Innovative and traditional profiles join different materials, edges and surfaces to create both classic and modern designs.

A complete range of profiles specifically engineered for tile and stone flooring and a comprehensive line of multipurpose profiles provide edging and finishing for most flooring on the market.

We offer solutions that are technical and aesthetic, perfectly complementing tiling and floor coverings of interior spaces.

Discreet, minimal, linear as well as decorative profile sections offer a vast range of design possibilities and guarantee state-of-the-art floor detailing.



Article	Code	Use	Page
Trimtec	TR	multipurpose	6
Trimtec	SR	edge finish	9
Bordertec	BSR	edge finish	10
Uptec	SUPA*	universal pedestals	11
Roundjolly	RJ	terminal prof. for elevated floors	12
Mosaictec	SJM	terminal prof. for elevated floors	12
Roundtec	RD	junction and transition	12
Squarejolly	SJ	Junction	13
Cubetec	CU	Junction	15
Cubetec	FI	Junction	15
Covertec	EP	junction and transition	15
Zerotec	ZRN60	junction and transition	16
Zerotec	ZRM	junction and transition	17
Zerotec	ZR60	junction ramp	17
Zerotec	ZR	junction ramp	18
Zerotec	ZRR	junction ramp	19
Linetec	AD	separation profile	20
Linetec	MB	separation profile	20
Linetec	PT	separation profile	20
Covertec	SP	Junction	21
Striptec	ST	existing floors	22
Striptec	STB/STP	existing floors	25
Leveltec	RPR	existing floors	26
Leveltec	RP	existing floors	26
Variotec	DC/DK	edge strip	28
Leveltec	ZP	junction and compensating edge	28
Variotec	DR/DS	junction and compensating edge	29
Linetec	PR/PQ/PU	junction and compensating edge	29
Multiclip	CLG	junction between floors	30
Multiclip	CLF	transition due to different heights	31
Multiclip	CLP	perimetral between floor and wall	32
Multiclip LVT	CL + CLB	base for multiclip LVT system	33
Multiclip LVT	CLG	junction between floors	33
Multiclip LVT	CLF	transition due to different heights	34
Multiclip LVT	CLP	perimetral between floor and wall	34
Multifix	CLG	junction between floors	35
Multicover	CLG	junction between floors	36
Multicover	CLF	transition due to different heights	36
Woodtec	LT	edge for wooden floors	37
Woodtec	LP	junct. and edge for wooden floors	38
Woodtec	LG/LS	junct. and edge for wooden floors	38
Carpetec	MG	carpet and edge junction	39
Carpetec	MP/MA	carpet and edge junction	39
Carpetec	MS/MD	carpet and edge junction	40
Multicurve	C*D	carpet and edge junction	40
Linotec	AP/AV	edge PVC	41
Entrytec	BU	carpet and panel inspection	42
Coprifilo	STC	carpet and panel inspection	42



Length: 2,70 meters

- SELFLINE/KIT PRE-CUT
0,90 and 1,35 m + €/m 0,53
- CURVELINE/BENDABLE
Cod TR-ILD + €/m 3,42

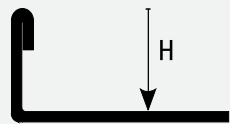

TR - I



IL/M IS IX

The images are inserted purely for illustrative purposes

trimtec >> TR in Stainless Steel AISI 304 - DIN 1.4301 Polished

	H = mm	Art.		Finish	€/ m	pc ■
	2	TR	20 IL	Polished	8,25	30
	3	TR	30 IL	Polished	8,48	30
	4,5	TR	45 IL	Polished	8,67	30
<input checked="" type="checkbox"/>	6	TR	60 IL	Polished	9,12	30
<input checked="" type="checkbox"/>	8	TR	80 IL	Polished	9,40	30
<input checked="" type="checkbox"/>	10	TR	100 IL	Polished	9,78	30
<input checked="" type="checkbox"/>	11	TR	110 IL	Polished	10,07	30
<input checked="" type="checkbox"/>	12,5	TR	125 IL	Polished	10,30	30
<input checked="" type="checkbox"/>	15	TR	150 IL	Polished	10,93	20
<input checked="" type="checkbox"/>	17,5	TR	175 IL	Polished	11,52	20
<input checked="" type="checkbox"/>	20	TR	200 IL	Polished	11,89	20
<input checked="" type="checkbox"/>	22,5	TR	225 IL	Polished	12,49	20
<input checked="" type="checkbox"/>	25	TR	250 IL	Polished	13,32	20
<input checked="" type="checkbox"/>	27,5	TR	275 IL	Polished	14,07	20
<input checked="" type="checkbox"/>	30	TR	300 IL	Polished	14,30	20

Profile protected with a removable film.

trimtec >> TR in Stainless Steel AISI 316 - DIN 1.4404 Polished

	H = mm	Art.		Finish	€/ m	pc ■
	6	TR	60 ILM	Polished	11,09	30
	8	TR	80 ILM	Polished	11,31	30
	10	TR	100 ILM	Polished	11,90	30
	11	TR	110 ILM	Polished	12,16	30
	12,5	TR	125 ILM	Polished	13,01	30
	15	TR	150 ILM	Polished	13,76	20

Profile protected with a removable film.

trimtec >> TR in Stainless Steel AISI 304 - DIN 1.4301 Brushed

	H = mm	Art.		Finish	€/ m	pc ■
	4,5	TR	45 IS	Brushed	11,20	30
	6	TR	60 IS	Brushed	11,67	30
	8	TR	80 IS	Brushed	11,96	30
	10	TR	100 IS	Brushed	12,34	30
	11	TR	110 IS	Brushed	12,62	30
	12,5	TR	125 IS	Brushed	12,88	30
	15	TR	150 IS	Brushed	13,49	20
	17,5	TR	175 IS	Brushed	14,11	20
	20	TR	200 IS	Brushed	14,49	20
	22,5	TR	225 IS	Brushed	15,09	20
	25	TR	250 IS	Brushed	15,94	20
	27,5	TR	275 IS	Brushed	16,70	20
	30	TR	300 IS	Brushed	16,93	20

Profile protected with a removable film.

trimtec >> TR in Stainless Steel AISI 304 - DIN 1.4301 Sanded

	H = mm	Art.		Finish	€/ m	pc ■
	10	TR	100 IX	Sanded	12,91	30
	11	TR	110 IX	Sanded	13,17	30
	12,5	TR	125 IX	Sanded	13,44	30



trimtec TR 45 IL



trimtec TR 125 IS

For quantities below 20 pcs 10% price increase applied.

Bendable with bending machine

Profile available in a pre-cut version



Length: 2,70 meters

- ☒ SELFLINE/KIT PRE-CUT
0,90 and 1,35 m + €/m 0,53
- ☑ CURVELINE/BENDABLE
Cod TR-AND + €/m 1,73
Cod TR-ASD + €/m 1,73

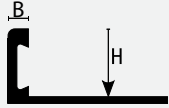

TR 20 ÷ 150 A
B = 3 mm

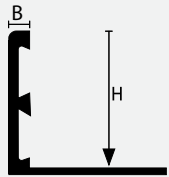

TR 175 ÷ 225 A
B = 3 mm



The images are inserted purely for illustrative purposes

trimtec >> TR in Natural Aluminum

	H = mm	Art.		Finish	€/ m	pc ■
☑	2	TR	20 AN	Natural	2,77	40
☑	3	TR	30 AN	Natural	2,80	40
☑☒	4,5	TR	45 AN	Natural	2,85	40
☑☒	6	TR	60 AN	Natural	2,90	40
☑☒	8	TR	80 AN	Natural	2,99	40
☑☒	10	TR	100 AN	Natural	3,15	40
☑☒	11	TR	110 AN	Natural	3,33	40
☑☒	12,5	TR	125 AN	Natural	3,51	40
☑☒	15	TR	150 AN	Natural	3,87	40
☑	17,5	TR	175 AN	Natural	4,23	40
☑	20	TR	200 AN	Natural	4,51	40
☑	22,5	TR	225 AN	Natural	4,78	40

trimtec >> TR in Anodized Aluminum

	H = mm	Art.		Finish	Variant	€/ m	pc ■
☑	2	TR	20 AS	Anodized	Silver	3,78	40 ☒
☑	3	TR	30 AS	Anodized	Silver	3,81	40 ☒
☑☒	4,5	TR	45 AS	Anodized	Silver	3,89	40 ☒
☑☒	6	TR	60 AS	Anodized	Silver	4,04	40 ☒
☑☒	8	TR	80 AS	Anodized	Silver	4,18	40 ☒
☑☒	10	TR	100 AS	Anodized	Silver	4,38	40 ☒
☑☒	11	TR	110 AS	Anodized	Silver	4,71	40 ☒
☑☒	12,5	TR	125 AS	Anodized	Silver	5,01	40 ☒
☑☒	15	TR	150 AS	Anodized	Silver	5,45	40 ☒
☑	17,5	TR	175 AS	Anodized	Silver	5,91	30 ☒
☑	20	TR	200 AS	Anodized	Silver	6,35	30 ☒
☑	22,5	TR	225 AS	Anodized	Silver	6,92	30 ☒

Stainless Steel



- + Stainless Steel AISI 304
- + Stainless Steel 316 for food and hospital environments
- + Sanded Stainless Steel (IX) Unique and elegant finish



trimtec TR 100 AN

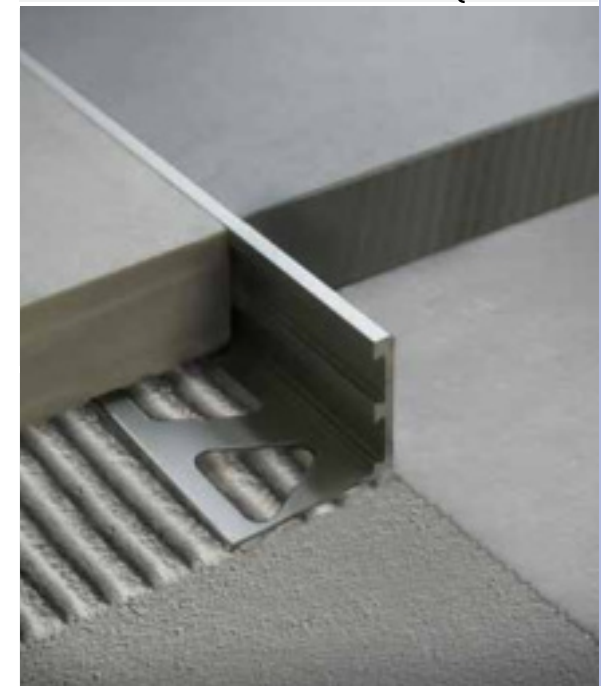

trimtec TR 200 AS

☒ For quantities below 20 pcs 10% price increase applied.
☒ Individually wrapped

☑ Bendable with bending machine
☒ Profile available in a pre-cut version



Length: 2,70 meters

- SELFLINE/KIT PRE-CUT
0,90 and 1,35 m + €/m 0,53
- CURVELINE/BENDABLE
Cod TR-OND + €/m 3,12

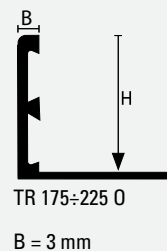
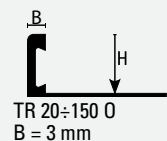

The images are inserted purely for illustrative purposes

trimtec >> TR in Natural Brass

	H = mm	Art.		Finish	€/ m	pc ■
<input checked="" type="checkbox"/>	2	TR	20 ON	Natural	8,11	10
<input checked="" type="checkbox"/>	3	TR	30 ON	Natural	8,19	10
<input checked="" type="checkbox"/>	4,5	TR	45 ON	Natural	8,45	10
<input checked="" type="checkbox"/>	6	TR	60 ON	Natural	8,72	10
<input checked="" type="checkbox"/>	8	TR	80 ON	Natural	9,23	10
<input checked="" type="checkbox"/>	10	TR	100 ON	Natural	9,74	10
<input checked="" type="checkbox"/>	12,5	TR	125 ON	Natural	10,54	10
<input checked="" type="checkbox"/>	15	TR	150 ON	Natural	11,41	10
<input checked="" type="checkbox"/>	17,5	TR	175 ON	Natural	12,58	10
<input checked="" type="checkbox"/>	20	TR	200 ON	Natural	13,40	10
<input checked="" type="checkbox"/>	22,5	TR	225 ON	Natural	14,06	10
<input checked="" type="checkbox"/>	25	TR	250 ON	Natural	15,02	10
<input checked="" type="checkbox"/>	27,5	TR	275 ON	Natural	15,72	10
<input checked="" type="checkbox"/>	30	TR	300 ON	Natural	16,31	10

trimtec >> TR in Polished Brass

	H = mm	Art.		Finish	€/ m	pc ■
	2	TR	20 OL	Polished	12,32	10 <input checked="" type="checkbox"/>
	3	TR	30 OL	Polished	12,40	10 <input checked="" type="checkbox"/>
	4,5	TR	45 OL	Polished	12,65	10 <input checked="" type="checkbox"/>
	6	TR	60 OL	Polished	12,93	10 <input checked="" type="checkbox"/>
	8	TR	80 OL	Polished	13,44	10 <input checked="" type="checkbox"/>
	10	TR	100 OL	Polished	13,95	10 <input checked="" type="checkbox"/>
	12,5	TR	125 OL	Polished	14,74	10 <input checked="" type="checkbox"/>
	15	TR	150 OL	Polished	15,60	10 <input checked="" type="checkbox"/>
	17,5	TR	175 OL	Polished	16,79	10 <input checked="" type="checkbox"/>
	20	TR	200 OL	Polished	17,61	10 <input checked="" type="checkbox"/>
	22,5	TR	225 OL	Polished	18,26	10 <input checked="" type="checkbox"/>
	25	TR	250 OL	Polished	19,23	10 <input checked="" type="checkbox"/>
	27,5	TR	275 OL	Polished	19,91	10 <input checked="" type="checkbox"/>
	30	TR	300 OL	Polished	20,52	10 <input checked="" type="checkbox"/>



Dovetail internal groove



- + Improved mechanical adhesion
- + Better tile protection
- + Better load resistance

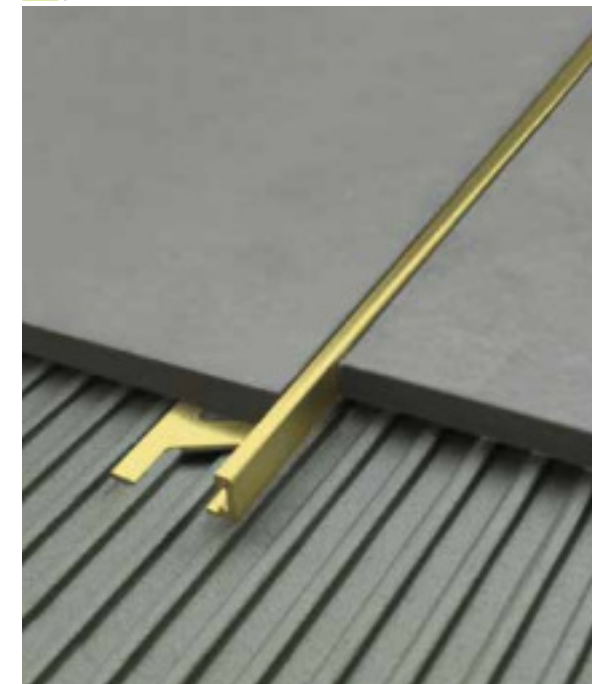

trim+tec TR 100 ON



trim+tec TR-OL

For quantities below 20 pcs 10% price increase applied.

- Bendable with bending machine
- Profile available in a pre-cut version



Length: 2,70 meters

- CURVELINE/BENDABLE
- Cod SR-ILD + €/m 3,41
- Cod SR-ASD + €/m 1,73
- Cod SR-OND + €/m 3,12

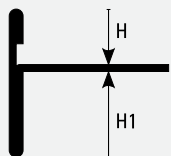

SR - I

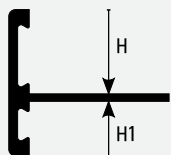

SR - AS
SR - 0

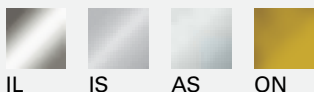

IL IS AS ON



OL

The images are inserted purely for illustrative purposes

trimtec >> SR in Stainless Steel AISI 304 - DIN 1.4301 Polished

	H/H1 mm	Art.			Finish	€/ m	pc ■
<input checked="" type="checkbox"/>	8/15	SR	8/15	IL	Polished	15,97	10
<input checked="" type="checkbox"/>	10/12,5	SR	10/12	IL	Polished	15,97	10

Profile protected with a removable film.

trimtec >> SR in Stainless Steel AISI 304 - DIN 1.4301 Brushed

	H/H1 mm	Art.			Finish	€/ m	pc ■
	8/15	SR	8/15	IS	Brushed	18,93	10
	10/12,5	SR	10/12	IS	Brushed	18,93	10

Profile protected with a removable film.

trimtec >> SR in Anodized Aluminum

	H/H1 mm	Art.			Finish	Variant	€/ m	pc ■
<input checked="" type="checkbox"/>	8/15	SR	8/15	AS	Anodized	Silver	8,06	10
<input checked="" type="checkbox"/>	10/12,5	SR	10/12	AS	Anodized	Silver	8,06	10

trimtec >> SR in Natural Brass

	H/H1 mm	Art.			Finish	€/ m	pc ■
<input checked="" type="checkbox"/>	8/15	SR	8/15	ON	Natural	16,19	10
<input checked="" type="checkbox"/>	10/12,5	SR	10/12	ON	Natural	16,19	10

trimtec >> SR in Polished Brass

	H/H1 mm	Art.			Finish	€/ m	pc ■
	8/15	SR	8/15	OL	Polished	20,37	10
	10/12,5	SR	10/12	OL	Polished	20,37	10



trim+tec SR-AS



trim+tec SR-AS



trim+tec SR-IS

edge finish

floor covering

For quantities below 20 pcs 10% price increase applied.
 Individually wrapped

Bendable with bending machine



Length: 2,70 meters

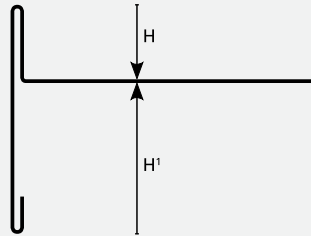

BSR - IL

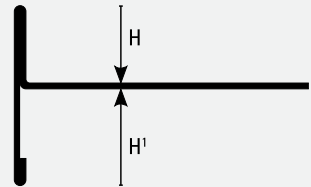

BSR - A

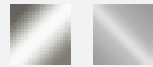

IL A22

The images are inserted purely for illustrative purposes

bordertec >> BSR in Stainless Steel AISI 304 - DIN 1.4301 Polished

H/H1 mm	Art.	Finish	€ / m	pc ■
10/35	BSR 10/35 IL	Polished	32,64	10
15/30	BSR 15/30 IL	Polished	32,64	10
20/25	BSR 20/25 IL	Polished	32,64	10

Profile protected with a removable film.

bordertec >> BSRE Outside corner in AISI 304 stainless steel- DIN14301

Art.	Finish	€ / pc	pc ■
BSRE 45 IL	Polished	39,89	10

Outside corner BSRE45 for BSR10/35, 15/30, 20/25

bordertec >> BSRG Junction in Stainless Steel AISI 304 - DIN 1.4301 Polished

Art.	Finish	€ / pc	pc ■
BSRG 45 IL	Polished	7,27	10

Junction BSRG 45 for BSR 10/35, 15/30, 20/25.

bordertec >> BSR in Powder Coated Aluminum

H/H1 mm	Art.	Finish	Variant	€ / m	pc ■
10/35	BSR 10/35 A22	Pow. Coated	Pastel Grey	21,38	5
15/30	BSR 15/30 A22	Pow. Coated	Pastel Grey	21,38	5
20/25	BSR 20/25 A22	Pow. Coated	Pastel Grey	21,38	5
20/40	BSR 20/40 A22	Pow. Coated	Pastel Grey	25,97	5
20/60	BSR 20/60 A22	Pow. Coated	Pastel Grey	28,61	5
20/80	BSR 20/80 A22	Pow. Coated	Pastel Grey	32,14	5
20/100	BSR 20/100 A22	Pow. Coated	Pastel Grey	36,58	5

More Modern Line finishings (24/25/60/64) upon request

bordertec >> BSRE outside corner in painted aluminum

H/H1 mm	Art.	Finish	Variant	€ / pc	pc ■
	BSRE 45 A22	Pow. Coated	Pastel Grey	29,55	10
20/40	BSRE 20/40 A22	Pow. Coated	Pastel Grey	35,92	10
20/60	BSRE 20/60 A22	Pow. Coated	Pastel Grey	39,59	10
20/80	BSRE 20/80 A22	Pow. Coated	Pastel Grey	44,46	10
20/100	BSRE 20/100 A22	Pow. Coated	Pastel Grey	50,57	10

Outside corner BSRE45 for BSR10/35, 15/30, 20/25

bordertec >> BSRG Junction in Powder Coated Aluminum

H/H1 mm	Art.	Finish	Variant	€ / pc	pc ■
	BSRG 45 A22	Pow. Coated	Pastel Grey	5,88	10
20/40	BSRG 20/40 A22	Pow. Coated	Pastel Grey	7,14	10
20/60	BSRG 20/60 A22	Pow. Coated	Pastel Grey	7,87	10
20/80	BSRG 20/80 A22	Pow. Coated	Pastel Grey	8,84	10
20/100	BSRG 20/100 A22	Pow. Coated	Pastel Grey	10,09	10

Junction BSRG 45 for BSR 10/35, 15/30, 20/25.



bordertec BSR-IL

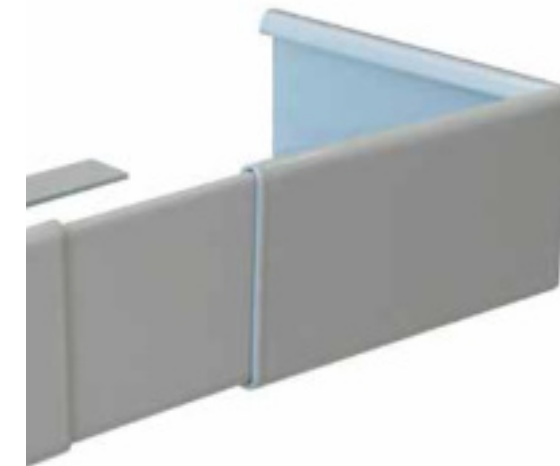

bordertec BSR-A22

☒ For quantities below 10 pcs 10% price increase applied.



Length: 2,70 meters

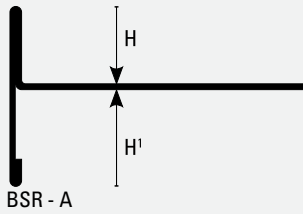

BSR - A



A50

The images are inserted purely for illustrative purposes

bordertec >> BSR in Powder Coated Aluminum Modern Line

H/H1 mm	Art.	Finish	Variant	€ / m	pc ■
10/35	BSR 10/35 A50	Pow. Coated	Embossed Micaceous	21,38	5
15/30	BSR 15/30 A50	Pow. Coated	Embossed Micaceous	21,38	5
20/25	BSR 20/25 A50	Pow. Coated	Embossed Micaceous	21,38	5
20/40	BSR 20/40 A50	Pow. Coated	Embossed Micaceous	25,97	5
20/60	BSR 20/60 A50	Pow. Coated	Embossed Micaceous	28,61	5
20/80	BSR 20/80 A50	Pow. Coated	Embossed Micaceous	32,14	5
20/100	BSR 20/100 A50	Pow. Coated	Embossed Micaceous	36,58	5

More Modern Line finishings (24/25/60/64) upon request

bordertec >> BSRE Outside corner in painted aluminum Modern line

H/H1 mm	Art.	Finish	Variant	€ / pc	pc ■
	BSRE 45 A50	Pow. Coated	Embossed Micaceous	29,55	10
20/40	BSRE 20/40 A50	Pow. Coated	Embossed Micaceous	35,92	10
20/60	BSRE 20/60 A50	Pow. Coated	Embossed Micaceous	39,59	10
20/80	BSRE 20/80 A50	Pow. Coated	Embossed Micaceous	44,46	10
20/100	BSRE 20/100 A50	Pow. Coated	Embossed Micaceous	50,57	10

More Modern Line finishings (24/25/60/64) upon request

Outside corner BSRE45 for BSR10/35, 15/30, 20/25

bordertec >> BSRG in Powder Coated Aluminum

H/H1 mm	Art.	Finish	Variant	€ / pc	pc ■
	BSRG 45 A50	Pow. Coated	Embossed Micaceous	5,88	10
20/40	BSRG 20/40 A50	Pow. Coated	Embossed Micaceous	7,14	10
20/60	BSRG 20/60 A50	Pow. Coated	Embossed Micaceous	7,87	10
20/80	BSRG 20/80 A50	Pow. Coated	Embossed Micaceous	8,84	10
20/100	BSRG 20/100 A50	Pow. Coated	Embossed Micaceous	10,09	10

More Modern Line finishings (24/25/60/64) upon request

Junction BSRG 45 for BSR 10/35, 15/30, 20/25.

uptec >> adjustable universal pedestals for raised floors - components

H = mm	Art.	Finish	€ / pc	pck ■
28 / 43	SUPAL	Low pedestal	4,20	24 pcs
43 / 58	SUPAS	Standard pedestal	4,39	24 pcs
30	SUPAR	Modular Ring	0,88	24 pcs

Check the complete range on page 166.

uptec >> accessories

Art.	Finish	€ / pc	pck ■
SUPA2	spacer - 2 mm tabs	1,53	240 pcs
SUPA4	Spacer - 4 mm tabs - also compatible with Al. joists	1,53	240 pcs
SUPAW	spacer - wooden joints	1,53	240 pcs
SUPAR 120	Big ring	2,63	24 pcs
SUPAK	3 functions adjusting key	72,69	1 pc

☒ For quantities below 10 pcs 10% price increase applied.

pkg = indivisible packaging

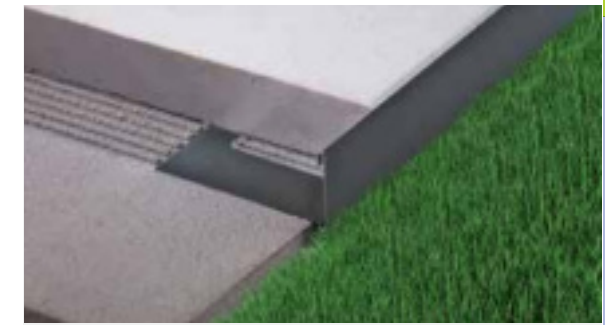

bordertec BSR-A50

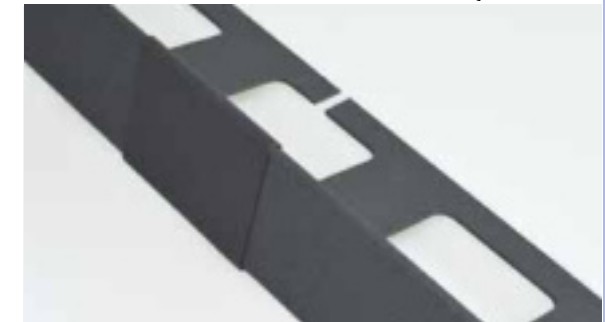

bordertec BSRE-A50

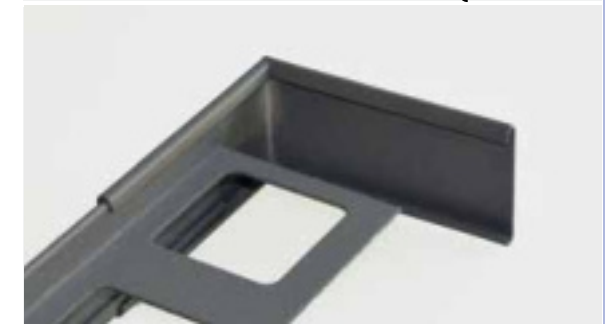

bordertec BSRG-A50



uptec SUPAS

edge finish

floor covering



Length: 2,70 meters

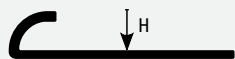

RJ 45 I



RJ 45 AS



IL IS AS

The images are inserted purely for illustrative purposes

roundjolly >> RJ in Stainless Steel AISI 304 - DIN 1.4301 Polished						
H = mm	Art.			Finish	€ / m	pc ■
4,5	RJ	45	IL	Polished	10,31	20

Profile protected with a removable film.

roundjolly >> RJ in Stainless Steel AISI 304 - DIN 1.4301 Brushed						
H = mm	Art.			Finish	€ / m	pc ■
4,5	RJ	45	IS	Brushed	12,89	20

Profile protected with a removable film.

roundjolly >> RJ in Anodized Aluminum							
H = mm	Art.			Finish	Variant	€ / m	pc ■
4,5	RJ	45	AS	Anodized	Silver	4,29	40



roundjolly RJ 45 IL

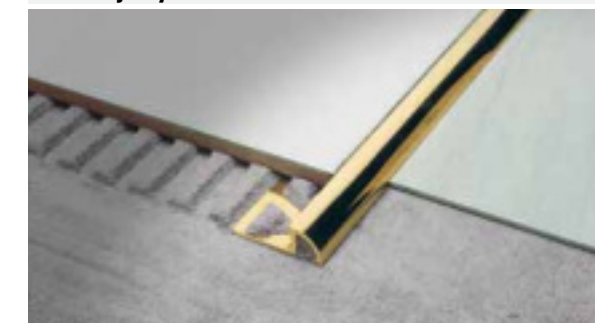

round+tec RD-OL

Length: 2,70 meters



RD - 0



ON OL

The images are inserted purely for illustrative purposes

roundtec >> RD in Natural Brass						
H = mm	Art.			Finish	€ / m	pc ■
8	RD	80	ON	Natural	15,15	10
10	RD	100	ON	Natural	16,31	10
12,5	RD	125	ON	Natural	20,41	10
15	RD	150	ON	Natural	26,66	10

roundtec >> RD in Polished Brass						
H = mm	Art.			Finish	€ / m	pc ■
8	RD	80	OL	Polished	19,35	10
10	RD	100	OL	Polished	20,52	10
12,5	RD	125	OL	Polished	24,60	10
15	RD	150	OL	Polished	30,87	10

Length: 2,70 meters

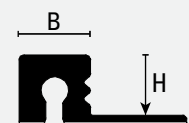

SJM 44 AS
B = 5,1 mm



AS

The images are inserted purely for illustrative purposes

mosaictec >> SJM in Anodized Aluminum for mosaic and thin tiles							
H = mm	Art.			Finish	Variant	€ / m	pc ■
4,4	SJM	44	AS	Anodized	Silver	5,58	40

squarecapsula >> SJC in Anodized Aluminum							
H = mm	Art.			Finish	Variant	€ / set	set ■
4,4	SJC	44	AS	Anodized	Silver	11,03	2 pcs

Universal end caps (internal and external corner, and three-way intersection). Loose pcs not available.

profiles for low thickness

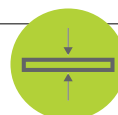

- + Mosaic profiles
- + Full range for thin tiles
- + Unique finishes



mosaictec SJM 44 AS

For quantities below 20 pcs 10% price increase applied.
 Individually wrapped



Length: 2,70 meters

CURVELINE/BENDABLE

Cod SJ-ILD + €/m 3,41

Visible side B:

H size + 1mm

e.g. SJ80 = 9x9mm

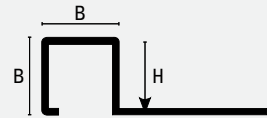

SJ - I



SJC - IL



IL/M

The images are inserted purely for illustrative purposes

squarejolly >> SJ in Stainless Steel AISI 304 - DIN 1.4301 Polished

	H = mm	Art.		Finish	€/ m	pc ■
<input checked="" type="checkbox"/>	6	SJ	60 IL	Polished	10,64	10
<input checked="" type="checkbox"/>	8	SJ	80 IL	Polished	11,20	10
<input checked="" type="checkbox"/>	9	SJ	90 IL	Polished	11,60	10
<input checked="" type="checkbox"/>	10	SJ	100 IL	Polished	12,13	10
<input checked="" type="checkbox"/>	11	SJ	110 IL	Polished	12,39	10
<input checked="" type="checkbox"/>	12,5	SJ	125 IL	Polished	12,91	10
<input checked="" type="checkbox"/>	15	SJ	150 IL	Polished	15,16	10

B = H + 1 mm. Profile protected with to removable film.

squarecapsule >> SJC End caps in Stainless Steel AISI 304 - DIN 1.4301 Polished

	H = mm	Art.		Finish	€/ set	set ■
	6	SJC	60 IL	Polished	30,53	2 pcs
	8	SJC	80 IL	Polished	30,53	2 pcs
	9	SJC	90 IL	Polished	30,53	2 pcs
	10	SJC	100 IL	Polished	30,53	2 pcs
	11	SJC	110 IL	Polished	30,53	2 pcs
	12,5	SJC	125 IL	Polished	30,53	2 pcs
	15	SJC	150 IL	Polished	30,53	2 pcs

Universal end caps (internal and external corner, and three-way intersection). Loose pcs not available.

squarejolly >> SJ in Stainless Steel AISI 316 - DIN 1.4404 Polished

	H = mm	Art.		Finish	€/ m	pc ■
	8	SJ	80 ILM	Polished	14,80	10
	9	SJ	90 ILM	Polished	15,20	10
	10	SJ	100 ILM	Polished	15,73	10
	11	SJ	110 ILM	Polished	16,01	10
	12,5	SJ	125 ILM	Polished	16,53	10
	15	SJ	150 ILM	Polished	18,80	10

B = H + 1 mm. Profile protected with to removable film.

squarecapsule >> SJC End caps in Stainless Steel AISI 316 - DIN 1.4404 Polished

	H = mm	Art.		Finish	€/ set	set ■
	8	SJC	80 ILM	Polished	38,43	2 pcs
	9	SJC	90 ILM	Polished	38,43	2 pcs
	10	SJC	100 ILM	Polished	38,43	2 pcs
	11	SJC	110 ILM	Polished	38,43	2 pcs
	12,5	SJC	125 ILM	Polished	38,43	2 pcs
	15	SJC	150 ILM	Polished	38,43	2 pcs

Universal end caps (internal and external corner, and three-way intersection). Loose pcs not available.



squarejolly SJ - IL



squarejolly SJ - ILM

transition

floor covering

For quantities below 20 pcs 10% price increase applied.

Bendable with bending machine



Length: 2,70 meters

Visible side B:

H size + 1mm

e.g. SJ80 = 9x9mm

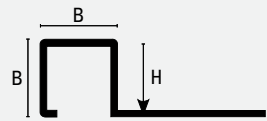

SJ - I
SJ - OL



SJC - IL



SJC - OL



IS IX OL

The images are inserted purely for illustrative purposes

squarejolly >> SJ in Stainless Steel AISI 304 - DIN 1.4301 Brushed

H = mm	Art.		Finish	€ / m	pc ■
6	SJ	60 IS	Brushed	13,21	10
8	SJ	80 IS	Brushed	13,79	10
9	SJ	90 IS	Brushed	14,18	10
10	SJ	100 IS	Brushed	14,72	10
11	SJ	110 IS	Brushed	14,99	10
12,5	SJ	125 IS	Brushed	15,52	10
15	SJ	150 IS	Brushed	17,80	10

B = H + 1 mm. Profile protected with to removable film.

squarecapsule >> SJC End caps in Stainless Steel AISI 304 - DIN 1.4301 Brushed

H = mm	Art.		Finish	€ / set	set ■
6	SJC	60 IS	Brushed	36,89	2 pcs
8	SJC	80 IS	Brushed	36,89	2 pcs
9	SJC	90 IS	Brushed	36,89	2 pcs
10	SJC	100 IS	Brushed	36,89	2 pcs
11	SJC	110 IS	Brushed	36,89	2 pcs
12,5	SJC	125 IS	Brushed	36,89	2 pcs
15	SJC	150 IS	Brushed	36,89	2 pcs

Universal end caps (internal and external corner, and three-way intersection). Loose pcs not available.

squarejolly >> SJ in Stainless Steel AISI 304 - DIN 1.4301 Sanded

H = mm	Art.		Finish	€ / m	pc ■
8	SJ	80 IX	Sanded	14,70	10
10	SJ	100 IX	Sanded	15,65	10
12,5	SJ	125 IX	Sanded	16,46	10

B = H + 1 mm. Profile protected with to removable film.

squarecapsule >> SJC End caps in Stainless Steel AISI 304 - DIN 1.4301 Sanded

H = mm	Art.		Finish	€ / set	set ■
8	SJC	80 IX	Sanded	30,98	2 pcs
10	SJC	100 IX	Sanded	30,98	2 pcs
12,5	SJC	125 IX	Sanded	30,98	2 pcs

Universal end caps (internal and external corner, and three-way intersection). Loose pcs not available.

squarejolly >> SJ in Polished Brass

H = mm	Art.		Finish	€ / m	pc ■
8	SJ	80 OL	Polished	14,80	10
10	SJ	100 OL	Polished	15,97	10
12,5	SJ	125 OL	Polished	17,52	10

B = H + 1 mm. Profile protected with to removable film.

squarecapsule >> SJC in Polished Brass

H = mm	Art.		Finish	€ / set	set ■
8	SJC	80 OL	Polished	23,24	2 pcs
10	SJC	100 OL	Polished	23,24	2 pcs
12,5	SJC	125 OL	Polished	23,24	2 pcs

Universal end caps (internal and external corner, and three-way intersection). Loose pcs not available.



squarejolly SJ 100 IS



squarejolly SJ - OL

☒ For quantities below 20 pcs 10% price increase applied.



Length: 2,70 meters

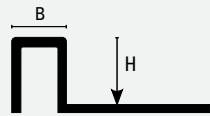

CU - I

B = 8 mm



IL IS

The images are inserted purely for illustrative purposes

cubetec >> CU in Stainless Steel AISI 304 - DIN 1.4301 Polished

H = mm	Art.	Finish	€ / m	pc ■
8	CU 80 IL	Polished	13,27	10
10	CU 100 IL	Polished	13,97	10
12,5	CU 125 IL	Polished	14,80	10

Profile protected with a removable film.

cubetec >> CU in Stainless Steel AISI 304 - DIN 1.4301 Brushed

H = mm	Art.	Finish	€ / m	pc ■
8	CU 80 IS	Brushed	16,23	10
10	CU 100 IS	Brushed	16,93	10
12,5	CU 125 IS	Brushed	17,77	10

Profile protected with a removable film.



cubetec CU-IS

Length: 2,70 meters

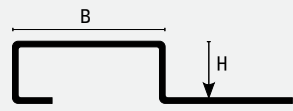

FI - I

B = 27 mm



IL IS

The images are inserted purely for illustrative purposes

cubetec >> FI in Stainless Steel AISI 304 - DIN 1.4301 Polished

H = mm	Art.	Finish	€ / m	pc ■
8	FI 80 IL	Polished	20,74	10
10	FI 100 IL	Polished	21,59	10
12,5	FI 125 IL	Polished	22,43	10

Profile protected with a removable film.

cubetec >> FI in Stainless Steel AISI 304 - DIN 1.4301 Brushed

H = mm	Art.	Finish	€ / m	pc ■
8	FI 80 IS	Brushed	23,71	10
10	FI 100 IS	Brushed	24,56	10
12,5	FI 125 IS	Brushed	25,40	10

Profile protected with a removable film.



cubetec FI-IL

Length: 2,70 meters



EP - IL



EP - O

B = 10 mm



IL ON OL

The images are inserted purely for illustrative purposes

covertec >> EP in Stainless Steel AISI 304 - DIN 1.4301 Polished

H = mm	Art.	Finish	€ / m	pc ■
8	EP 80 IL	Polished	12,14	10
10	EP 100 IL	Polished	12,91	10
12,5	EP 125 IL	Polished	14,29	10

Profile protected with a removable film.

covertec >> EP in Natural Brass

H = mm	Art.	Finish	€ / m	pc ■
8	EP 80 ON	Natural	12,53	10
10	EP 100 ON	Natural	13,32	10
12,5	EP 125 ON	Natural	15,53	10

covertec >> EP in Polished Brass

H = mm	Art.	Finish	€ / m	pc ■
8	EP 80 OL	Polished	16,74	10 ☐
10	EP 100 OL	Polished	17,52	10 ☐
12,5	EP 125 OL	Polished	19,74	10 ☐



covertec EP-OL

☒ For quantities below 20 pcs 10% price increase applied.



Length: 2,70 meters

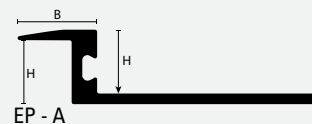

EP - A

B = 7,5 mm

covertec >> EP in Anodized Aluminum

H = mm	Art.	Finish	Variant	€ / m	pc ■
6	EP 60 AS	Anodized	Silver	5,60	10
6	EP 60 AT	Anodized	Titan	6,41	10

Length: 2,70 meters

H1 = 6 mm

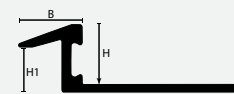

ZRN 60/80 A

B = 8,5 mm

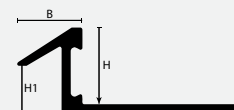

ZRN 60/100 A

B = 8,5 mm

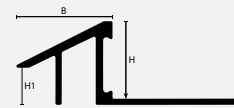

ZRN 60/125 A

B = 15,5 mm

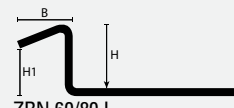

ZRN 60/80 I

B = 7 mm

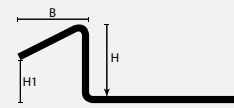

ZRN 60/100 I

B = 10 mm

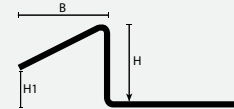

ZRN 60/125 I

B = 15 mm

zerotec >> ZRN60 in Anodized Aluminum

H = mm	Art.	Finish	Variant	€ / m	pc ■
8	ZRN 60/80 AS	Anodized	Silver	6,01	30
10	ZRN 60/100 AS	Anodized	Silver	6,41	30
12,5	ZRN 60/125 AS	Anodized	Silver	8,27	30
8	ZRN 60/80 AT	Anodized	Titan	6,83	30
10	ZRN 60/100 AT	Anodized	Titan	8,27	30
12,5	ZRN 60/125 AT	Anodized	Titan	9,31	30

zerotec >> ZRN60 in Bright Polished Anodized Aluminum

H = mm	Art.	Finish	Variant	€ / m	pc ■
8	ZRN 60/80 ATSB	Bright Polished Brushed Anodized	Titan	8,82	30
10	ZRN 60/100 ATSB	Bright Polished Brushed Anodized	Titan	9,55	30
12,5	ZRN 60/125 ATSB	Bright Polished Brushed Anodized	Titan	11,60	30

zerotec >> ZRN60 in Brushed Anodized Aluminum

H = mm	Art.	Finish	Variant	€ / m	pc ■
8	ZRN 60/80 AMSB	Brushed Anodized	Antique Bronze	8,82	30
10	ZRN 60/100 AMSB	Brushed Anodized	Antique Bronze	9,55	30
12,5	ZRN 60/125 AMSB	Brushed Anodized	Antique Bronze	11,60	30

zerotec >> ZRN in stainless steel AISI 304- DIN 14301 Bright

	H = mm	Art.	Finish	€ / m	pc ■
new	8	ZRN 60/80 IL	Polished	12,25	10
new	10	ZRN 60/100 IL	Polished	13,85	10
new	12,5	ZRN 60/125 IL	Polished	15,77	10



covertec EP 60 AT



zerotec ZRN 60/80 AT

✗ For quantities below 20 pcs 10% price increase applied.

☑ Individually wrapped



Length: 2,70 meters

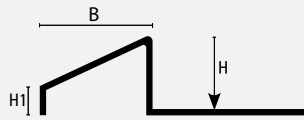

ZRM - I

Measure B:

ZRM80IL - B=12 mm

ZRM100IL - B=15 mm

ZRM125IL - B=17,5 mm

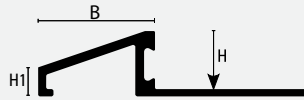

ZRM 80 AS

H1 = 5 mm

Measure B:

ZRM80A* - B=16 mm

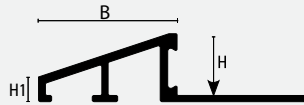

ZRM - A

H1 = 5 mm

Measure B:

ZRM100A* - B=22,3 mm

ZRM125A* - B=26,6 mm



IL AS ATSB

The images are inserted purely for illustrative purposes

zerotec >> ZRM in Stainless Steel AISI 304 - DIN 1.4301 Polished

H = mm	Art.	Finish	€/ m	pc ■
8	ZRM 80 IL	Polished	13,61	10
10	ZRM 100 IL	Polished	14,72	10
12,5	ZRM 125 IL	Polished	16,54	10

Profile protected with a removable film.

zerotec >> ZRM in Anodized Aluminum

H = mm	Art.	Finish	Variant	€/ m	pc ■
8	ZRM 80 AS	Anodized	Silver	6,05	20
10	ZRM 100 AS	Anodized	Silver	6,86	20
12,5	ZRM 125 AS	Anodized	Silver	7,82	20
10	ZRM 100 ATSB	Bright Polished Brushed Anod.	Titan	15,30	20



zerotec ZRM - IL



zerotec ZR60/-AS

Length: 2,70 meters



ZR60/- A

H1 = 6 mm

Measure B:

ZR60/-A* - B=20 mm



AS

zerotec >> ZR60 in Anodized Aluminum

H = mm	Art.	Finish	Variant	€/ m	pc ■
8	ZR60/ 80 AS	Anodized	Silver	6,05	30
10	ZR60/ 100 AS	Anodized	Silver	6,86	30
12,5	ZR60/ 125 AS	Anodized	Silver	7,82	25
10	ZR60/ 100 AT	Anodized	Titan	9,39	30

For quantities below 20 pcs 10% price increase applied.

Individually wrapped

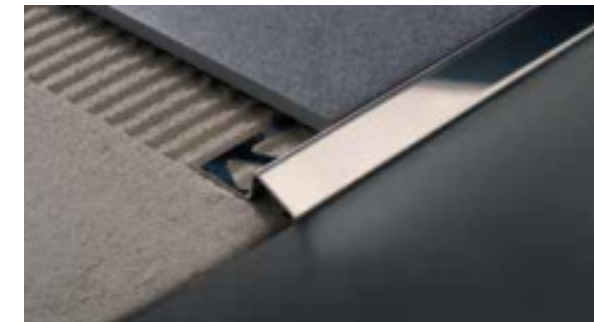

zerotec ZR-IL

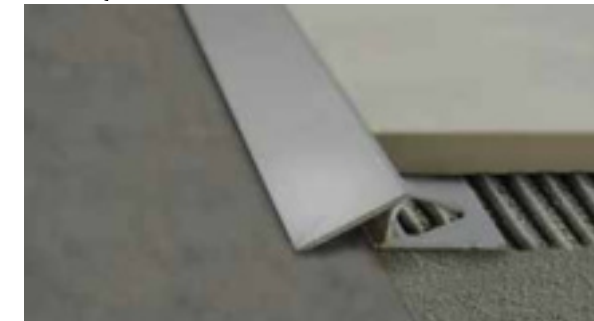

zerotec ZR-AT

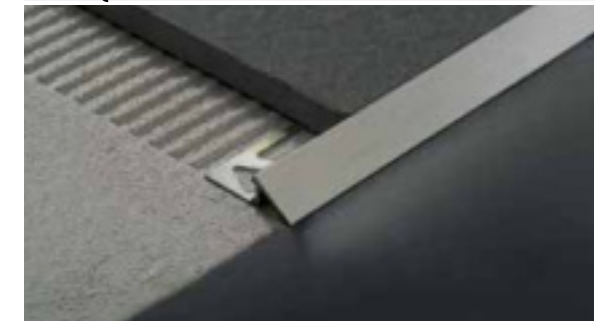

zerotec ZR-ATSB



zerotec ZR-IX

Length: 2,70 meters

- ☒ SELFLINE/KIT PRE-CUT
0,90 and 1,35 m + €/m 0,53
- ☑ CURVELINE/BENDABLE
Cod ZR-AND + €/m 1,72
Cod ZR-ASD + €/m 1,72

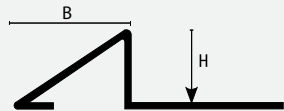

ZR - I

Measure B:
 ZR80IL - B=15,5 mm
 ZR100IL - B=18,5 mm
 ZR125IL - B=19,5 mm
 ZR150IL - B=22,5 mm

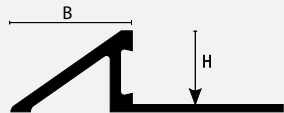

ZR - A

Measure B:
 ZR50A* - B=15,1 mm
 ZR80A* - B=13,7 mm
 ZR100A* - B=16,4 mm
 ZR125A* - B=20,0 mm

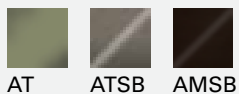

The images are inserted purely for illustrative purposes

zerotec >> ZR in Stainless Steel AISI 304 - DIN 1.4301 Polished

	H = mm	Art.			Finish	€/ m	pc ■
☒	8	ZR	80	IL	Polished	13,86	10
☒	10	ZR	100	IL	Polished	15,00	10
	12,5	ZR	125	IL	Polished	16,88	10
	15	ZR	150	IL	Polished	20,50	10

Profile protected with a removable film.

zerotec >> ZR in Stainless Steel AISI 304 - DIN 1.4301 Sanded

	H = mm	Art.			Finish	€/ m	pc ■
	10	ZR	100	IX	Sanded	18,79	10

Profile protected with a removable film.

zerotec >> ZR in Natural Aluminum

	H = mm	Art.			Finish	€/ m	pc ■
☑☒	8	ZR	80	AN	Natural	4,42	10
☑☒	10	ZR	100	AN	Natural	4,97	10
☑☒	12,5	ZR	125	AN	Natural	5,67	10

zerotec >> ZR in Anodized Aluminum

	H = mm	Art.			Finish	Variant	€/ m	pc ■
☑☒	5	ZR	50	AS	Anodized	Silver	4,81	40 ☑
☑☒	8	ZR	80	AS	Anodized	Silver	6,05	40 ☑
☑☒	10	ZR	100	AS	Anodized	Silver	6,86	30 ☑
☑☒	12,5	ZR	125	AS	Anodized	Silver	7,82	25 ☑
	10	ZR	100	AT	Anodized	Titan	11,51	30 ☑
	12,5	ZR	125	AT	Anodized	Titan	12,16	25 ☑

☑☒ Ideal for vinyl floors (LVT)

zerotec >> ZR in Bright Polished Anodized Aluminum

H = mm	Art.			Finish	Variant	€/ m	pc ■
10	ZR	100	ATSB	Bright Polished Brushed Anodized	Titan	14,36	30 ☑
12,5	ZR	125	ATSB	Bright Polished Brushed Anodized	Titan	15,02	25 ☑

zerotec >> ZR in Brushed Anodized Aluminum

H = mm	Art.			Finish	Variant	€/ m	pc ■
10	ZR	100	AMSB	Brushed Anodized	Antique Bronze	17,80	30 ☑
12,5	ZR	125	AMSB	Brushed Anodized	Antique Bronze	18,45	25 ☑

☑ For quantities below 20 pcs 10% price increase applied.

☑ Individually wrapped

☑ Bendable with bending machine

☑ Profile available in a pre-cut version



Length: 2,70 meters

- ☒ SELFLINE/KIT PRE-CUT
0,90 and 1,35 m + €/m 0,53
- ☑ CURVELINE/BENDABLE
Cod ZR-OND + €/m 3,12

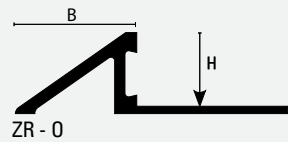

Measure B:
 ZR800* - B=13,6 mm
 ZR1000* - B=16,4 mm
 ZR1250* - B=19,9mm
 ZR1500* - B=22,7 mm

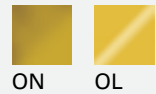

The images are inserted purely for illustrative purposes

zerotec >> ZR in Natural Brass							
	H = mm	Art.			Finish	€/ m	pc ■
☑	8	ZR	80	ON	Natural	13,86	10
☑	10	ZR	100	ON	Natural	15,93	10
☒	12,5	ZR	125	ON	Natural	19,96	10
☒	15	ZR	150	ON	Natural	24,31	10

zerotec >> ZR in Polished Brass							
	H = mm	Art.			Finish	€/ m	pc ■
	8	ZR	80	OL	Polished	18,07	10 ☒
	10	ZR	100	OL	Polished	20,14	10 ☒
	12,5	ZR	125	OL	Polished	24,16	10 ☒
	15	ZR	150	OL	Polished	28,50	10 ☒

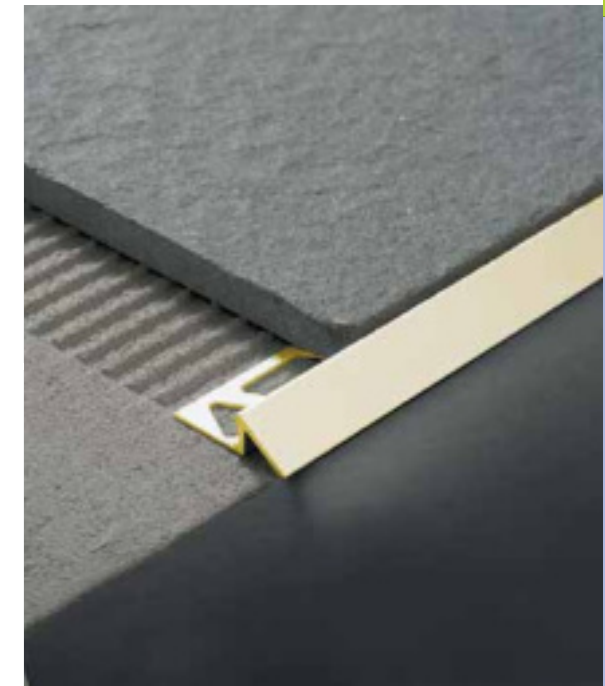

zero+tec ZR-OL

Length: 2,70 meters

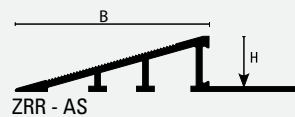

Measure B:
 ZRR100AS - B=43,2 mm
 ZRR125AS - B=48,2 mm
 ZRR150AS - B=53,0 mm



The images are inserted purely for illustrative purposes

ramptec >> ZRR in anodized aluminum								
	H = mm	Art.			Finish	Variant	€/ m	pc ■
	10	ZRR	100	AS	Anodized	Silver	16,93	15 ☒
	12,5	ZRR	125	AS	Anodized	Silver	18,96	15 ☒
	15	ZRR	150	AS	Anodized	Silver	21,85	15 ☒



ramptec ZRR-AS

- ☒ For quantities below 20 pcs 10% price increase applied.
- ☒ Individually wrapped

- ☑ Bendable with bending machine
- ☒ Profile available in a pre-cut version



Length: 2,70 meters

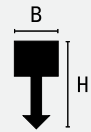

AD - AN
AD - ON



AN ON

The images are inserted purely for illustrative purposes

linetec >> AD in Natural Aluminum

BxH mm	Art.	Finish	€ / m	pc ■
5 x 10	AD 10 AN	Natural	3,10	40

linetec >> AD in Natural Brass

BxH mm	Art.	Finish	€ / m	pc ■
5 x 10	AD 10 ON	Natural	7,95	30
5 x 14	AD 14 ON	Natural	8,99	30



linetec AD-AN

Length: 2,70 meters

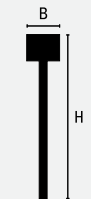

MB - AN
MB - ON



AN ON

The images are inserted purely for illustrative purposes

linetec >> MB in Natural Aluminum

BxH mm	Art.	Finish	€ / m	pc ■
5 x 25	MB 5 AN	Natural	3,79	40

linetec >> MB in Natural Brass

BxH mm	Art.	Finish	€ / m	pc ■
5 x 25	MB 5 ON	Natural	10,39	30
10 x 25	MB 10 ON	Natural	16,04	30



linetec MB-ON

Length: 2,70 meters

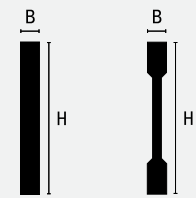

PT - IN PT - ON



IN ON

The images are inserted purely for illustrative purposes

linetec >> PT in Stainless Steel AISI 304 - DIN 1.4301 Natural

BxH mm	Art.	Finish	€ / m	pc ■
2,5 x 10	PT 100 IN	Natural	5,87	10
2,5 x 15	PT 150 IN	Natural	7,69	10
2,5 x 20	PT 200 IN	Natural	10,03	10
2,5 x 40	PT 400 IN	Natural	17,94	10

linetec >> PT in Natural Brass

BxH mm	Art.	Finish	€ / m	pc ■
2,5 x 10	PT 100 ON	Natural	9,62	10
2,5 x 15	PT 150 ON	Natural	10,77	10
2,5 x 20	PT 200 ON	Natural	13,25	10
2,5 x 40	PT 400 ON	Natural	17,52	10
5,0 x 30	PT 305 ON	Natural	37,64	10



linetec PT-ON

☒ For quantities below 20 pcs 10% price increase applied.

Length: 2,70 meters

- SELFLINE/KIT PRE-CUT
0,90 and 1,35 m + €/m 1,20
SP9AS only 0,90 m
- CURVELINE/BENDABLE

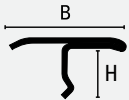

SP - I

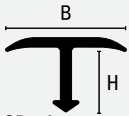

SP - A



The images are inserted purely for illustrative purposes

covertec >> SP in Stainless Steel AISI 304 - DIN 1.4301 Polished

	BxH mm	Art.			Finish	€/ m	pc ■
<input checked="" type="checkbox"/>	14 x 7	SP	14	IL	Polished	9,85	10
<input checked="" type="checkbox"/>	20 x 7	SP	20	IL	Polished	12,79	10

Profile protected with a removable film.

covertec >> SP in Stainless Steel AISI 304 - DIN 1.4301 Brushed

	BxH mm	Art.			Finish	€/ m	pc ■
	14 x 7	SP	14	IS	Brushed	12,27	10
	20 x 7	SP	20	IS	Brushed	15,22	10

Profile protected with a removable film.

covertec >> SP in Stainless Steel AISI 304 - DIN 1.4301 Sanded

	BxH mm	Art.			Finish	€/ m	pc ■
	14 x 7	SP	14	IX	Sanded	13,11	10

covertec >> SP in Anodized Aluminum

	BxH mm	Art.			Finish	Variant	€/ m	pc ■
<input checked="" type="checkbox"/>	9 x 4.5	SP	9	AS	Anodized	Silver	3,01	50 <input checked="" type="checkbox"/>
<input checked="" type="checkbox"/>	14 x 7	SP	14	AS	Anodized	Silver	3,61	20
<input checked="" type="checkbox"/>	20 x 7	SP	20	AS	Anodized	Silver	6,29	20

Ideal for vinyl floors (LVT)

covertec >> SP in Wood Effect Aluminum

	BxH mm	Art.			Finish	Variant	€/ m	pc ■
<input checked="" type="checkbox"/>	14 x 7	SP	14	AC	Wood effect	Maple	8,26	10
<input checked="" type="checkbox"/>	14 x 7	SP	14	CI	Wood effect	Cherry	8,26	10
<input checked="" type="checkbox"/>	14 x 7	SP	14	FA	Wood effect	Beechwood	8,26	10
<input checked="" type="checkbox"/>	14 x 7	SP	14	NC	Wood effect	Light Walnut	8,26	10
<input checked="" type="checkbox"/>	14 x 7	SP	14	NS	Wood effect	Dark Walnut	8,26	10
<input checked="" type="checkbox"/>	14 x 7	SP	14	RO	Wood effect	Oak	8,26	10
<input checked="" type="checkbox"/>	14 x 7	SP	14	RS	Wood effect	Bleached	8,26	10
<input checked="" type="checkbox"/>	14 x 7	SP	14	WE	Wood effect	Wengé	8,26	10
<input checked="" type="checkbox"/>	20 x 7	SP	20	AC	Wood effect	Maple	10,83	10
<input checked="" type="checkbox"/>	20 x 7	SP	20	CI	Wood effect	Cherry	10,83	10
<input checked="" type="checkbox"/>	20 x 7	SP	20	FA	Wood effect	Beechwood	10,83	10
<input checked="" type="checkbox"/>	20 x 7	SP	20	NC	Wood effect	Light Walnut	10,83	10
<input checked="" type="checkbox"/>	20 x 7	SP	20	NS	Wood effect	Dark Walnut	10,83	10
<input checked="" type="checkbox"/>	20 x 7	SP	20	RO	Wood effect	Oak	10,83	10
<input checked="" type="checkbox"/>	20 x 7	SP	20	RS	Wood effect	Bleached	10,83	10
<input checked="" type="checkbox"/>	20 x 7	SP	20	WE	Wood effect	Wengé	10,83	10



covertec SP 14 IX

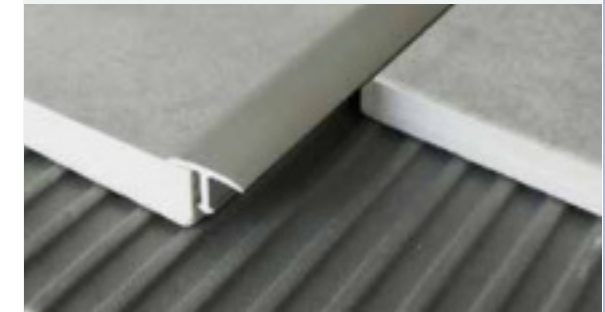

covertec SP 14 AS



covertec SP 20 CI

For quantities below 20 pcs 10% price increase applied.
 Individually wrapped

Bendable with bending machine
 Profile available in a pre-cut version



Length: 2,70 meters

- SELFLINE/KIT PRE-CUT
0,90 and 1,35 m + €/m 1,20
SP9AS only 0,90 m
- CURVELINE/BENDABLE

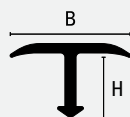

SP - 0

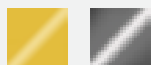

OL OC

The images are inserted purely for illustrative purposes



covertec >> SP in Polished Brass

	BxH mm	Art.			Finish	€/ m	pc ■
☒	14 x 7	SP	14	OL	Polished	7,50	15 ☒
☒	20 x 7	SP	20	OL	Polished	10,96	10 ☒
☒	26 x 7	SP	26	OL	Polished	13,18	15 ☒



covertec >> SP in Chromed Brass

	BxH mm	Art.			Finish	€/ m	pc ■
	14 x 7	SP	14	OC	Chrome	15,02	15 ☒
	20 x 7	SP	20	OC	Chrome	20,28	10 ☒

Length: 2,70 meters

- SELFLINE-A/KIT PRE-CUT
0,90 and 1,35 m + €/m 1,20
- SELFLINE-N/PRE CUT
0,90 and 1,35 m + €/m 1,22
- SELFLINE-F/KIT PRE-CUT
0,90 and 1,35 m + €/m 1,53

5 + 5 x 0,90 m
7 + 7 x 1,35 m
screws + dowels

(Not included in the packaging)

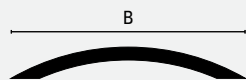

ST-IL



IL

The images are inserted purely for illustrative purposes



striptec >> ST in stainless sttel AISI304 not drilled

	B = mm	Art.			Finish	Variant	€/ m	pc ■
☒	18	ST	18	ILA	Polished	Self-Adhesive	5,67	30 ☒
☒	30	ST	30	ILA	Polished	Self-Adhesive	5,75	20 ☒
☒	35	ST	35	ILA	Polished	Self-Adhesive	6,90	20 ☒

Screws not included
Profile protected with a removable film.



striptec >> ST in stainless steel aisi304 drilled

	B = mm	Art.			Finish	Variant	€/ m	pc ■
☒	30	ST	30	ILF	Polished	Drilled	4,01	10
☒	35	ST	35	ILF	Polished	Drilled	5,20	10

Screws not included
Profile protected with a removable film.



striptec >> ST in stainless sttel AISI304 not drilled

	B = mm	Art.			Finish	Variant	€/ m	pc ■
☒	18	ST	18	ILN	Polished	not Drilled	3,96	10

Screws not included
Profile protected with a removable film.



covertec SP 14 OL



striptec ST 18 IL

☒ For quantities below 20 pcs 10% price increase applied.
☒ Individually wrapped

☒ Profile available in a pre-cut version



Length: 2,70 meters

SELFLINE-A/KIT PRE-CUT

0,90 and 1,35 m + €/m 1,20

SELFLINE-F/KIT PRE-CUT

0,90 and 1,35 m + €/m 1,53

5 + 5 x 0,90 m
7 + 7 x 1,35 m
screws + dowels

not included

(Not included in the packaging)

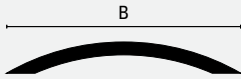

ST-A



AS AB AO

The images are inserted purely for illustrative purposes

striptec >> ST in Anodized Aluminum - Self-Adhesive

	B = mm	Art.	Finish	Variant	€/ m	pc ■
	18	ST 18 ASA	Anodized	Silver Self-Adhesive	5,30	40
	18	ST 18 ABA	Anodized	Bronze Self-Adhesive	5,30	40
	18	ST 18 AOA	Anodized	Gold Self-Adhesive	5,30	40
⊗	30	ST 30 ASA	Anodized	Silver Self-Adhesive	5,48	40
⊗	30	ST 30 ABA	Anodized	Bronze Self-Adhesive	5,48	40
⊗	30	ST 30 AOA	Anodized	Gold Self-Adhesive	5,48	40
⊗	35	ST 35 ASA	Anodized	Silver Self-Adhesive	6,56	40
⊗	35	ST 35 ABA	Anodized	Bronze Self-Adhesive	6,56	40
⊗	35	ST 35 AOA	Anodized	Gold Self-Adhesive	6,56	40
⊗	40	ST 40 ASA	Anodized	Silver Self-Adhesive	7,87	30
⊗	40	ST 40 ABA	Anodized	Bronze Self-Adhesive	7,87	30
⊗	40	ST 40 AOA	Anodized	Gold Self-Adhesive	7,87	30

striptec >> ST in Anodized Aluminum - Drilled

	B = mm	Art.	Finish	Variant	€/ m	pc ■
	18	ST 18 ASF	Anodized	Silver Drilled	3,85	40
	18	ST 18 ABF	Anodized	Bronze Drilled	3,85	40
	18	ST 18 AOF	Anodized	Gold Drilled	3,85	40
⊗	30	ST 30 ASF	Anodized	Silver Drilled	4,05	40
⊗	30	ST 30 ABF	Anodized	Bronze Drilled	4,05	40
⊗	30	ST 30 AOF	Anodized	Gold Drilled	4,05	40
⊗	35	ST 35 ASF	Anodized	Silver Drilled	5,11	40
⊗	35	ST 35 ABF	Anodized	Bronze Drilled	5,11	40
⊗	35	ST 35 AOF	Anodized	Gold Drilled	5,11	40
⊗	40	ST 40 ASF	Anodized	Silver Drilled	6,41	30
⊗	40	ST 40 ABF	Anodized	Bronze Drilled	6,41	30
⊗	40	ST 40 AOF	Anodized	Gold Drilled	6,41	30



striptec ST 30 AS

Length: 2,70 meters

SELFLINE-N/PRE CUT

0,90 and 1,35 m + €/m 1,22

SELFLINE-F/KIT PRE-CUT

0,90 and 1,35 m + €/m 1,53

5 + 5 x 0,90 m
7 + 7 x 1,35 m
screws + dowels

not included

(Not included in the packaging)

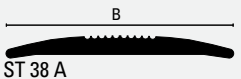

ST 38 A



AS AB AO

striptec >> ST38 in Anodized Aluminum - Self-Adhesive

	B = mm	Art.	Finish	Variant	€/ m	pc ■
⊗	38	ST 38 ASA	Anodized	Silver Self-Adhesive	7,94	30
⊗	38	ST 38 ABA	Anodized	Bronze Self-Adhesive	7,94	30
⊗	38	ST 38 AOA	Anodized	Gold Self-Adhesive	7,94	30

striptec >> ST38 in Anodized Aluminum - Drilled

	B = mm	Art.	Finish	Variant	€/ m	pc ■
⊗	38	ST 38 ASF	Anodized	Silver Drilled	6,49	30
⊗	38	ST 38 AOF	Anodized	Gold Drilled	6,49	30
⊗	38	ST 38 ABF	Anodized	Bronze Drilled	6,49	30



striptec ST 38 ASF

⊗ For quantities below 20 pcs 10% price increase applied.

⊗ Individually wrapped

⊗ Profile available in a pre-cut version

existing floors

floor covering



Length: 2,70 meters

- SELFLINE-A/KIT PRE-CUT
0,90 and 1,35 m + €/m 1,20
- SELFLINE-F/KIT PRE-CUT
0,90 and 1,35 m + €/m 1,53

5 + 5 x 0,90 m
7 + 7 x 1,35 m

screws + dowels

(Not included in the packaging)

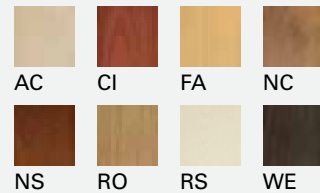
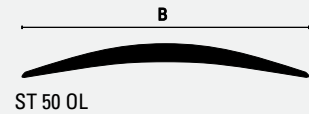
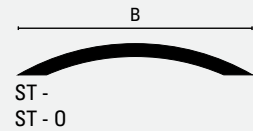

The images are inserted purely for illustrative purposes

strip+tec >> ST 30 in Wood Effect Aluminum - Self-Adhesive

	B = mm	Art.	Finish	Variant	€/ m	pc ■
⊗	30	ST 30 ACA	Wood effect	Maple - Self-Adhesive	10,81	40
⊗	30	ST 30 CIA	Wood effect	Cherry - Self-Adhesive	10,81	40
⊗	30	ST 30 FAA	Wood effect	Beechwood - Self-Adh.	10,81	40
⊗	30	ST 30 NCA	Wood effect	Light Walnut -Self-Adh.	10,81	40
⊗	30	ST 30 NSA	Wood effect	Dark Walnut -Self-Adh.	10,81	40
⊗	30	ST 30 RSA	Wood effect	Whitened Oak Adhesive	10,81	40
⊗	30	ST 30 ROA	Wood effect	Oak - Self-Adhesive	10,81	40
⊗	30	ST 30 WEA	Wood effect	Wengè - Self-Adhesive	10,81	40

strip+tec >> ST 30 in Wood Effect Aluminum - Drilled

	B = mm	Art.	Finish	Variant	€/ m	pc ■
⊗	30	ST 30 ACF	Wood effect	Maple Drilled	9,34	40
⊗	30	ST 30 CIF	Wood effect	Cherry Drilled	9,34	40
⊗	30	ST 30 FAF	Wood effect	Beechwood Drilled	9,34	40
⊗	30	ST 30 NCF	Wood effect	Light Walnut Drilled	9,34	40
⊗	30	ST 30 NSF	Wood effect	Dark Walnut Drilled	9,34	40
⊗	30	ST 30 ROF	Wood effect	Oak Drilled	9,34	40
⊗	30	ST 30 RSF	Wood effect	Bleached Drilled	9,34	40
⊗	30	ST 30 WEF	Wood effect	Wengè Drilled	9,34	40

strip+tec >> ST in Polished Brass - Self-Adhesive

	B = mm	Art.	Finish	Variant	€/ m	pc ■
⊗	18	ST 18 OLA	Polished	Self-Adhesive	7,96	30
⊗	30	ST 30 OLA	Polished	Self-Adhesive	8,12	20
⊗	35	ST 35 OLA	Polished	Self-Adhesive	10,82	20
⊗	50	ST 50 OLA	Polished	Self-Adhesive	38,10	10

Profile protected with a removable film.

strip+tec >> ST in Polished Brass - not Drilled

	B = mm	Art.	Finish	Variant	€/ m	pc ■
⊗	18	ST 18 OLN	Polished	not Adhesive	6,02	20

Profile protected with a removable film.

strip+tec >> ST in Polished Brass - Drilled

	B = mm	Art.	Finish	Variant	€/ m	pc ■
⊗	30	ST 30 OLF	Polished	Drilled	6,39	20
⊗	35	ST 35 OLF	Polished	Drilled	8,95	20
⊗	50	ST 50 OLF	Polished	Drilled	36,20	10

Profile protected with a removable film.



strip+tec ST 30 CI



strip+tec ST 30 RS

⊗ For quantities below 20 pcs 10% price increase applied.

⊗ Profile available in a pre-cut version



Length: 2,70 meters

- SELFLINE-A/KIT PRE-CUT 0,90 and 1,35 m + €/m 1,23
- SELFLINE-F/KIT PRE-CUT 0,90 and 1,35 m + €/m 1,52

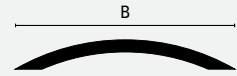

STP 30 O



OL

The images are inserted purely for illustrative purposes

striptec >> STP in Polished Brass - Self-Adhesive							
	B = mm	Art.		Finish	Variant	€/ m	pc ■
☉	30	STP	30 OLA	Polished	Self-Adhesive	10,61	20 ☐

Profile protected with a removable film.

striptec >> STP in Polished Brass - Drilled							
	B = mm	Art.		Finish	Variant	€/ m	pc ■
☉	30	STP	30 OLF	Polished	Drilled	8,86	20 ☐

Profile protected with a removable film.

Length: 2,70 meters

- SELFLINE-A/KIT PRE-CUT 0,90 and 1,35 m + €/m 1,23
- SELFLINE-F/KIT PRE-CUT 0,90 and 1,35 m + €/m 1,52

5 + 5 x 0,90 m
7 + 7 x 1,35 m

screws + dowels

(Not included in the packaging)

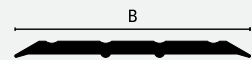

STB - A



AS AB AO

The images are inserted purely for illustrative purposes

striptec >> STB in Anodized Aluminum - Self-Adhesive							
	B = mm	Art.		Finish	Variant	€/ m	pc ■
☉	25	STB	25 ASA	Anodized	Silver Self-Adhesive	5,60	30 ☐
☉	25	STB	25 ABA	Anodized	Bronze Self-Adhesive	5,60	30 ☐
☉	25	STB	25 AOA	Anodized	Gold Self-Adhesive	5,60	30 ☐
☉	35	STB	35 ASA	Anodized	Silver Self-Adhesive	6,85	30 ☐
☉	35	STB	35 ABA	Anodized	Bronze Self-Adhesive	6,85	30 ☐
☉	35	STB	35 AOA	Anodized	Gold Self-Adhesive	6,85	30 ☐

striptec >> STB in Anodized Aluminum - Drilled							
	B = mm	Art.		Finish	Variant	€/ m	pc ■
☉	25	STB	25 ASF	Anodized	Silver Drilled	4,14	30 ☐
☉	25	STB	25 ABF	Anodized	Bronze Drilled	4,14	30 ☐
☉	25	STB	25 AOF	Anodized	Gold Drilled	4,14	30 ☐
☉	35	STB	35 ASF	Anodized	Silver Drilled	5,41	30 ☐
☉	35	STB	35 ABF	Anodized	Bronze Drilled	5,41	30 ☐
☉	35	STB	35 AOF	Anodized	Gold Drilled	5,41	30 ☐



striptec STP-OL



existing floors

floor covering

☒ For quantities below 20 pcs 10% price increase applied.

☐ Individually wrapped

☉ Profile available in a pre-cut version



Length: 2,70 meters

- SELFLINE-A/KIT PRE-CUT
0,90 and 1,35 m + €/m 1,23
- SELFLINE-F/KIT PRE-CUT
0,90 and 1,35 m + €/m 1,52

5 + 5 x 0,90 m
7 + 7 x 1,35 m

screws + dowels

(Not included in the packaging)

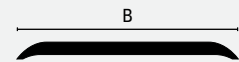

STB - OL



OL

The images are inserted purely for illustrative purposes



striptec >> STB in Polished Brass - Self-Adhesive

	B = mm	Art.			Finish	Variant	€/ m	pc ■
⊗	30	STB	30	OLA	Polished	Self-Adhesive	15,51	15
⊗	35	STB	35	OLA	Polished	Self-Adhesive	20,27	15
⊗	40	STB	40	OLA	Polished	Self-Adhesive	23,30	15

Profile protected with a removable film.



striptec >> STB in Polished Brass - Drilled

	B = mm	Art.			Finish	Variant	€/ m	pc ■
⊗	30	STB	30	OLF	Polished	Drilled	13,78	15
⊗	35	STB	35	OLF	Polished	Drilled	18,36	15
⊗	40	STB	40	OLF	Polished	Drilled	21,43	15

Profile protected with a removable film.

Length: 2,70 meters

- SELFLINE-A/KIT PRE-CUT
0,90 and 1,35 m + €/m 1,20

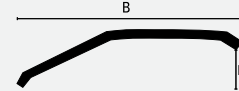

RPR 39 OL

H = for thicknesses from 8 to 14 mm



OL



leveltec >> RPR in Brass - Self-Adhesive

	B = mm	Art.			Finish	Variant	€/ m	pc ■
⊗	39	RPR	39	OLA	Polished	Self-Adhesive	21,37	10

Profile protected with a removable film.



leveltec >> RPR in Brass - not Drilled

	B = mm	Art.			Finish	Variant	€/ m	pc ■
⊗	39	RPR	39	OLN	Polished	not Drilled	19,62	10

Profile protected with a removable film.

Length: 2,70 meters

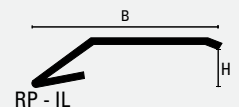

RP - IL



IL

The images are inserted purely for illustrative purposes



leveltec >> RP in Stainless Steel AISI 304 - DIN 1.4301 Polished - Self-Adhesive

	HxB mm	Art.			Finish	Variant	€/ m	pc ■
	5 x 29	RP	50	ILA	Polished	Self-Adhesive	7,22	10
	8 x 34	RP	80	ILA	Polished	Self-Adhesive	9,28	10
	11 x 38	RP	110	ILA	Polished	Self-Adhesive	11,00	10

Profile protected with a removable film.



leveltec >> RP in Stainless Steel AISI 304 - DIN 1.4301 Polished - Drilled

	HxB mm	Art.			Finish	Variant	€/ m	pc ■
	5 x 29	RP	50	ILF	Polished	Drilled	5,64	10
	8 x 34	RP	80	ILF	Polished	Drilled	7,72	10
	11 x 38	RP	110	ILF	Polished	Drilled	9,42	10

Thickness 10/10 - protected with a removable film.



striptec STB-OLF

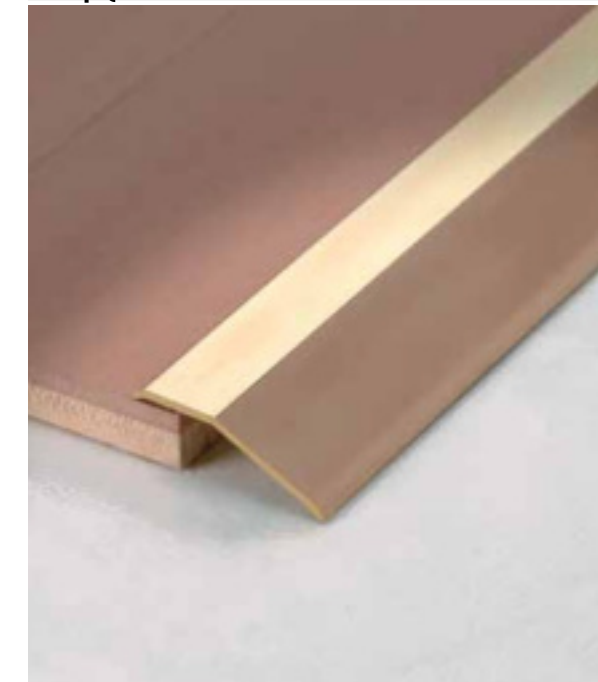

leveltec RPR

⊗ For quantities below 20 pcs 10% price increase applied.

⊞ Individually wrapped

⊞ Profile available in a pre-cut version



Length: 2,70 meters

- SELFLINE-A/KIT PRE-CUT 0,90 and 1,35 m + €/m 1,23
- SELFLINE-F/KIT PRE-CUT 0,90 and 1,35 m + €/m 1,52

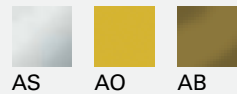
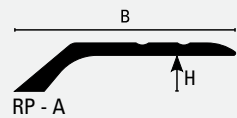

The images are inserted purely for illustrative purposes

leveltec >> RP in Anodized Aluminum - Self-Adhesive

	HxB mm	Art.	Finish	Variant	€/ m	pc ■
⊗	5 x 31	RP 50 ASA	Anodized	Silver Self-Adhesive	6,71	30 ⊗
⊗	8 x 34	RP 80 ASA	Anodized	Silver Self-Adhesive	8,85	30 ⊗
⊗	5 x 31	RP 50 AOA	Anodized	Gold Self-Adhesive	6,71	30 ⊗
⊗	8 x 34	RP 80 AOA	Anodized	Gold Self-Adhesive	8,85	30 ⊗
⊗	5 x 31	RP 50 ABA	Anodized	Bronze Self-Adhesive	6,71	30 ⊗
⊗	8 x 34	RP 80 ABA	Anodized	Bronze Self-Adhesive	8,85	30 ⊗

leveltec >> RP in Anodized Aluminum - Drilled

	HxB mm	Art.	Finish	Variant	€/ m	pc ■
⊗	5 x 31	RP 50 ASF	Anodized	Silver Drilled	5,26	30 ⊗
⊗	8 x 34	RP 80 ASF	Anodized	Silver Drilled	7,39	30 ⊗
⊗	5 x 31	RP 50 AOF	Anodized	Gold Drilled	5,26	30 ⊗
⊗	8 x 34	RP 80 AOF	Anodized	Gold Drilled	7,39	30 ⊗
⊗	5 x 31	RP 50 ABF	Anodized	Bronze Drilled	5,26	30 ⊗
⊗	8 x 34	RP 80 ABF	Anodized	Bronze Drilled	7,39	30 ⊗

Length: 2,70 meters

- SELFLINE-A/KIT PRE-CUT 0,90 and 1,35 m + €/m 1,23
- SELFLINE-F/KIT PRE-CUT 0,90 and 1,35 m + €/m 1,52

5 + 5 x 0,90 m
7 + 7 x 1,35 m

screws + dowels not included (Not included in the packaging)

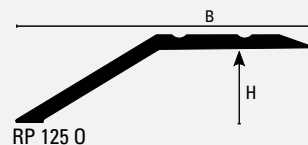
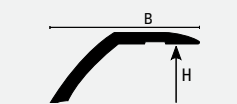
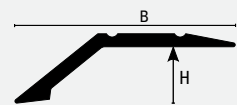
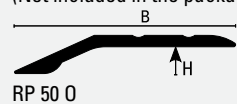

leveltec >> RP in Polished Brass - Self-Adhesive

	HxB mm	Art.	Finish	Variant	€/ m	pc ■
⊗	4.5 x 32	RP 50 OLA	Polished	Self-Adhesive	17,08	10 ⊗
⊗	8 x 34	RP 80 OLA	Polished	Self-Adhesive	23,56	10 ⊗
⊗	10 x 25	RP 100 OLA	Polished	Self-Adhesive	19,14	10 ⊗
⊗	12.5 x 45	RP 125 OLA	Polished	Self-Adhesive	26,58	10 ⊗

Profile protected with a removable film.

leveltec >> RP in bright brass- drilled

	HxB mm	Art.	Finish	Variant	€/ m	pc ■
⊗	4.5 x 32	RP 50 OLF	Polished	Drilled	15,33	10 ⊗
⊗	8 x 34	RP 80 OLF	Polished	Drilled	21,79	10 ⊗
⊗	10 x 25	RP 100 OLF	Polished	Drilled	17,39	10 ⊗
⊗	12.5 x 45	RP 125 OLF	Polished	Drilled	24,84	10 ⊗

Profile protected with a removable film.

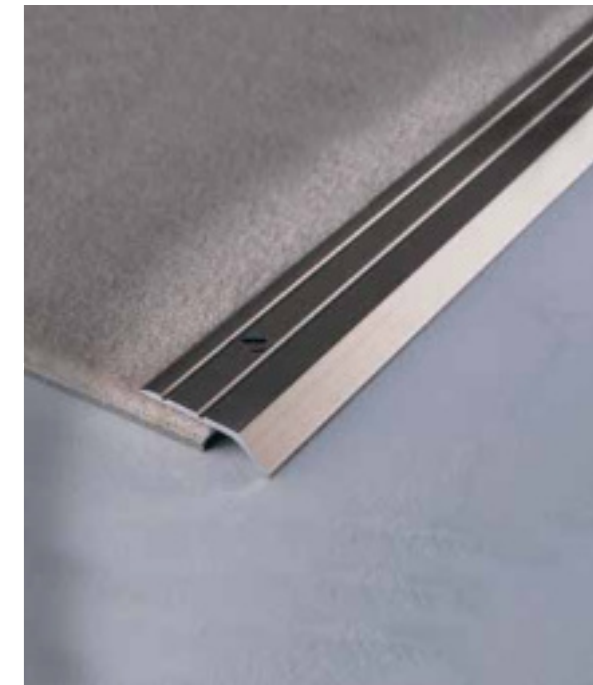

leveltec RP 50 ABF



leveltec RP 80 OL

⊗ For quantities below 20 pcs 10% price increase applied.
⊗ Individually wrapped

⊗ Profile available in a pre-cut version



Length: 2,70 meters

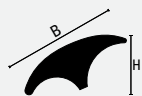

DC 22
H for thicknesses from 7 to 14 mm

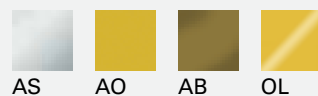

variotec >> DC in Anodized Aluminum

B = mm	Art.			Finish	Variant	€ / m	pc ■
22	DC	22	AS	Anodized	Silver	6,79	12
22	DC	22	AO	Anodized	Gold	6,79	12
22	DC	22	AB	Anodized	Bronze	6,79	12

variotec >> DC in Brass

B = mm	Art.			Finish	€ / m	pc ■
22	DC	22	OL	Polished	22,29	10



variotec DC

Length: 2,70 meters

SELFLINE/KIT PRE-CUT
0,90 and 1,35 m + €/m 1,20



DK 37
H for thicknesses from 7 to 12 mm

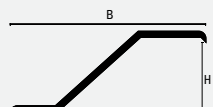

DK 47
H for thicknesses from 12 to 16 mm



variotec >> DK in Stainless Steel AISI 304 - DIN 1.4301 Polished - Self-Adhesive

B = mm	Art.			Finish	€ / m	pc ■
37	DK	37	ILA	Polished	9,52	20
47	DK	47	ILA	Polished	11,96	20

Thickness 10/10 - protected with a removable film.

variotec >> DK in Anodized Aluminum - Self-Adhesive

B = mm	Art.			Finish	Variant	€ / m	pc ■
37	DK	37	ASA	Anodized	Silver Self-Adhesive	6,89	20
37	DK	37	AOA	Anodized	Gold Self-Adhesive	6,89	20
37	DK	37	ABA	Anodized	Bronze Self-Adhesive	6,89	20

variotec >> DK in Polished Brass - Self-Adhesive

B = mm	Art.			Finish	Variant	€ / m	pc ■
37	DK	37	OLA	Polished	Self-Adhesive	12,88	20
47	DK	47	OLA	Polished	Self-Adhesive	17,09	15

Thickness 10/10 - protected with a removable film.



variotec DC-AS



variotec DK

Length: 2,70 meters



ZP 100 OL



OL
The images are inserted purely for illustrative purposes

leveltec >> ZP in Polished Brass

H = mm	Art.			Finish	€ / m	pc ■
10	ZP	100	OL	Polished	22,01	10



leveltec ZP 100 OL

For quantities below 20 pcs 10% price increase applied.
 Individually wrapped

Profile available in a pre-cut version



Length: 2,70 meters

SELFLINE-A/KIT PRE-CUT
0,90 and 1,35 m + €/m 1,20

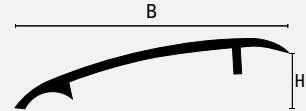

DR 36
H for thicknesses from 7 to 13 mm

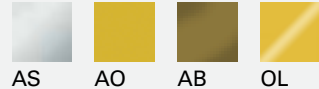

variotec >> DR in Anodized Aluminum - Self-Adhesive

	B = mm	Art.			Finish	Variant	€/ m	pc ■
	36	DR	36	ASA	Anodized	Silver Self-Adhesive	6,64	30
	36	DR	36	AOA	Anodized	Gold Self-Adhesive	6,64	30
	36	DR	36	ABA	Anodized	Bronze Self-Adhesive	6,64	30

variotec >> DR in Polished Brass - Self-Adhesive

	B = mm	Art.			Finish	Variant	€/ m	pc ■
	36	DR	36	OLA	Polished	Self-Adhesive	24,10	15

Profile protected with a removable film.

Length: 2,70 meters

SELFLINE-A/KIT PRE-CUT
0,90 and 1,35 m + €/m 1,20

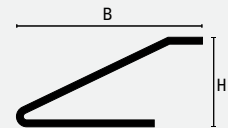

DS 27
H for thicknesses from 7 to 12 mm

variotec >> DS in Stainless Steel AISI 304 - DIN 1.4301 Polished - Self-Adhesive

	B = mm	Art.			Finish	€/ m	pc ■
	27	DS	27	ILA	Polished	11,83	15

Thickness 10/10. Profile protected with a removable film.

variotec >> DS in Polished Brass - Self-Adhesive

	B = mm	Art.			Finish	Variant	€/ m	pc ■
	27	DS	27	OLA	Polished	Self-Adhesive	14,95	15

Thickness 10/10. Profile protected with a removable film.

Length: 2,70 meters

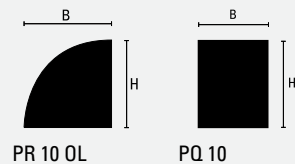

PR 10 OL PQ 10

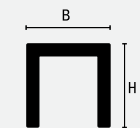

PU 10 OL



The images are inserted purely for illustrative purposes

linetec >> PR in Polished Brass

	HxB mm	Art.			Finish	€/ m	pc ■
	10 x 10	PR	10	OL	Polished	21,05	10

linetec >> PQ in Stainless Steel AISI 304 - DIN 1.4301 Natural

	HxB mm	Art.			Finish	€/ m	pc ■
	10 x 10	PQ	10	IN	Natural	24,58	10

linetec >> PQ in Natural Brass

	HxB mm	Art.			Finish	€/ m	pc ■
	10 x 8	PQ	10	ON	Natural	21,84	10

linetec >> PU in Polished Brass

	HxB mm	Art.			Finish	€/ m	pc ■
	10 x 10	PU	10	OL	Polished	14,46	10

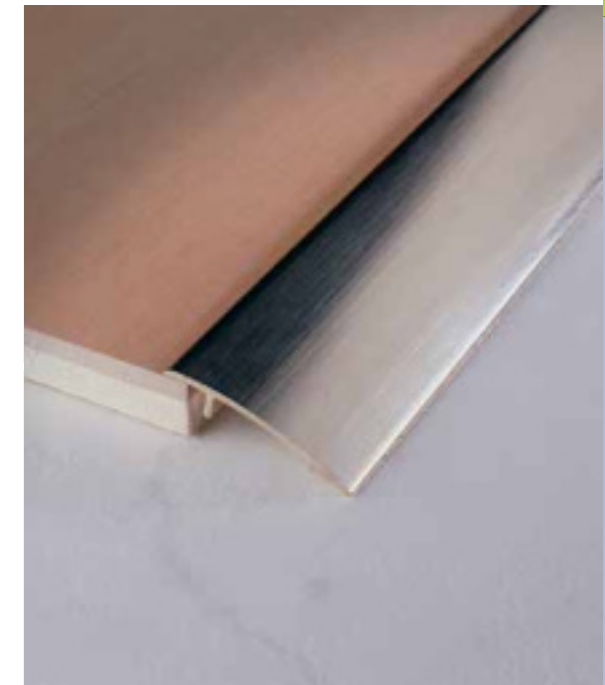

vario+tec DR 36 OL



linetec PR 10 OL

junction and compensating edge

floor covering

For quantities below 20 pcs 10% price increase applied.
 Individually wrapped

Profile available in a pre-cut version



The Multiclip system is ideal to compensate floor thicknesses from 6 to 20 mm (+/- 1,5 mm)

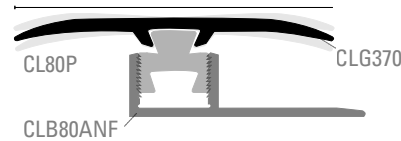

The Multiclip system for floors is composed of a pre-drilled base (CLB 80 AN*), a clip (CL 80 P) and profiles (CLG 370, CLP 270, CLF 450, CLF 490) in 14 finishes. Used as joint or end profiles to compensate level differences from 6 to 20 mm. The combination between the clip system and the symmetrical shape of the CLG 370 profile allows movement which compensates level differences of up 1.5 mm.

Length: 2,70 meters



CL 80 P
1 piece for 6 to 10mm
2 pieces 11 to 15mm



CLB 80 AN

multiclip >> CL in Synthetic Resin

H = mm	Art.			Finish	€ / m	pc ■
8	CL	80	P	Synthetic Resin	1,35	120

multiclip >> CLB Drilled fixing base in Natural Aluminum

H = mm	Art.			Finish	Variant	€ / m	pc ■
8	CLB	80	ANF	Natural	Drilled	5,55	10

multiclip >> CLB 80 Perforated fixing base in Natural Aluminum

H = mm	Art.			Finish	Variant	€ / m	pc ■
8	CLB	80	ANT	Natural	Perforated	5,47	10

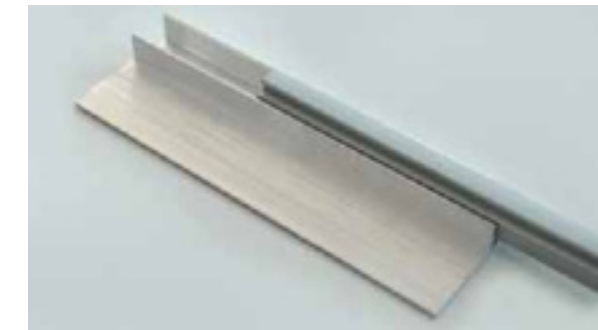

CLB80 + CL80

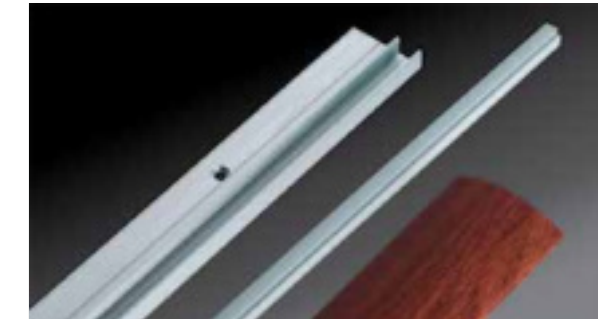

multiclip

Length: 2,70 meters

SELFLINE-C/PRE-CUT
0,90 and 1,35 m + €/m 8,44

5 + 5 x 0,90 m
7 + 7 x 1,35 m
screws + dowels

(Not included in the packaging)

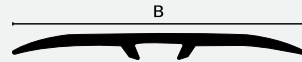

CLG 370
1 clip - H=6 to 10 mm
2 clip - H=11 to 15 mm
3 clip - H=16 to 20 mm

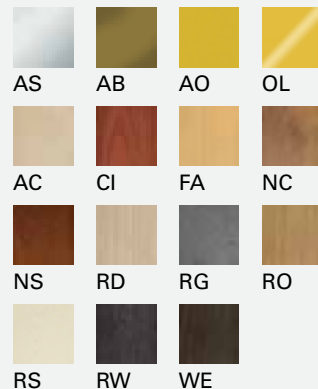

multiclip >> CLG in Anodized Aluminum

B = mm	Art.			Finish	Variant	€ / m	pc ■
37	CLG	370	AS	Anodized	Silver	7,03	30
37	CLG	370	AB	Anodized	Bronze	7,03	30
37	CLG	370	AO	Anodized	Gold	7,03	30

Clip and base to be order separately in the standard version 2,70 m

multiclip >> CLG370 in High resistance Wood Laminated Aluminum

B = mm	Art.			Finish	Variant	€ / m	pc ■
37	CLG	370	AC	Wood effect	Maple	12,33	30
37	CLG	370	CI	Wood effect	Cherry	12,33	30
37	CLG	370	FA	Wood effect	Beechwood	12,33	30
37	CLG	370	NC	Wood effect	Light Walnut	12,33	30
37	CLG	370	NS	Wood effect	Dark Walnut	12,33	30
37	CLG	370	RO	Wood effect	Oak	12,33	30
37	CLG	370	RD	Wood effect	Decapè Oak	16,05	30
37	CLG	370	RG	Wood effect	Grey Oak	16,05	30
37	CLG	370	RS	Wood effect	Bleached	12,33	30
37	CLG	370	RW	Wood effect	Wengè Oak	16,05	30
37	CLG	370	WE	Wood effect	Wengè	12,33	30

Clip and base to be order separately in the standard version 2,70 m

multiclip >> CLG370 in Polished Brass

B = mm	Art.			Finish	€ / m	pc ■
37	CLG	370	OL	Polished	19,99	10

Profile protected with a removable film. Clip and base to be order separately in the standard version 2,70 m.



multiclip CLG 370 RD

The images are inserted purely for illustrative purposes

For quantities below 20 pcs 10% price increase applied.
Individually wrapped

Profile available in a pre-cut version



Length: 2.70 meters

SELFLINE-C/PRE-CUT
36" and 53"

5 + 5 x 0,90 m
7 + 7 x 1,35 m
screws + dowels

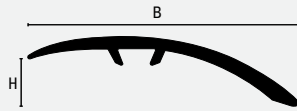

CLF 450

1 clip- H=6±10mm
2 clip- H=11±15mm
3 clip- H=16±20mm

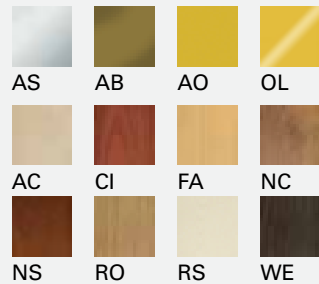

SELFLINE-C/PRE-CUT
0,90 and 1,35 m + €/m 9,78

5 + 5 x 0,90 m
7 + 7 x 1,35 m
screws + dowels

(Not included in the packaging)

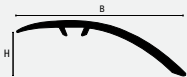

CLF 490

2 clip - H=12±18

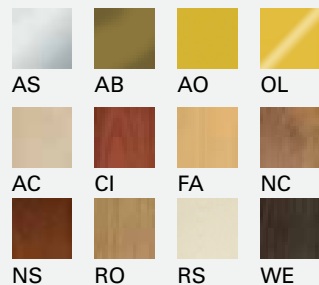

The images are inserted purely for illustrative purposes

multiclip >> CLF450 in Anodized Aluminum

	B = mm	Art.	Finish	Variant	€/ m	pc ■
	45	CLF 450 AS	Anodized	Silver	7,77	20
	45	CLF 450 AB	Anodized	Bronze	7,77	20
	45	CLF 450 AO	Anodized	Gold	7,77	20

Clip and base to be order separately in the standard version 2.70m.

multiclip >> CLF450 in Wood Effect Aluminum

	B = mm	Art.	Finish	Variant	€/ m	pc ■
	45	CLF 450 AC	Wood effect	Maple	13,90	20
	45	CLF 450 CI	Wood effect	Cherry	13,90	20
	45	CLF 450 FA	Wood effect	Beechwood	13,90	20
	45	CLF 450 NC	Wood effect	Light Walnut	13,90	20
	45	CLF 450 NS	Wood effect	Dark Walnut	13,90	20
	45	CLF 450 RO	Wood effect	Oak	13,90	20
	45	CLF 450 RS	Wood effect	Bleached	13,90	20
	45	CLF 450 WE	Wood effect	Wengè	13,90	20

Clip and base to be order separately in the standard version 2.70m.

multiclip >> CLF450OL in Polished Brass

	B = mm	Art.	Finish	€/ m	pc ■
	45	CLF 450 OL	Polished	24,68	10

Profile protected with a removable film. Clip and base to be order separately in the standard version 2.70m.

multiclip >> CLF490 in Anodized Aluminum

	B = mm	Art.	Finish	Variant	€/ m	pc ■
	49	CLF 490 AS	Anodized	Silver	9,15	20
	49	CLF 490 AB	Anodized	Bronze	9,15	20
	49	CLF 490 AO	Anodized	Gold	9,15	20

Base and plastic rail to be ordered separately. In the 490 version you have to use 2 plastic rails

multiclip >> CLF490 in Wood Effect Aluminum

	B = mm	Art.	Finish	Variant	€/ m	pc ■
	49	CLF 490 AC	Wood effect	Maple	14,77	20
	49	CLF 490 CI	Wood effect	Cherry	14,77	20
	49	CLF 490 FA	Wood effect	Beechwood	14,77	20
	49	CLF 490 NC	Wood effect	Light Walnut	14,77	20
	49	CLF 490 NS	Wood effect	Dark Walnut	14,77	20
	49	CLF 490 RO	Wood effect	Oak	14,77	20
	49	CLF 490 RS	Wood effect	Bleached	14,77	20
	49	CLF 490 WE	Wood effect	Wengè	14,77	20

Base and plastic rail to be ordered separately. In the 490 version you have to use 2 plastic rails

multiclip >> CLF490 OL in Polished Brass

	B = mm	Art.	Finish	€/ m	pc ■
	49	CLF 490 OL	Polished	28,29	10

Base and plastic rail to be ordered separately. In the 490 version you have to use 2 plastic rails



multiclip CLF 450 AS



multiclip CLF 450 RS

For quantities below 20 pcs 10% price increase applied.
 Individually wrapped

Profile available in a pre-cut version

multiclip - 6 to 20 mm

floor covering



Length: 2,70 meters

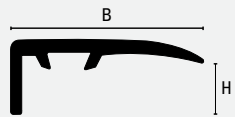

CLP 270

- 1 clip - H=6 to 10 mm
- 2 clip - H=11 to 15 mm
- 3 clip - H=16 to 20 mm

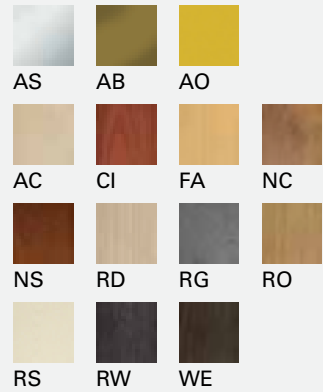

multiclip >> CLP270 in Anodized Aluminum

B = mm	Art.	Finish	Variant	€ / m	pc ■
27	CLP 270 AS	Anodized	Silver	7,35	30
27	CLP 270 AB	Anodized	Bronze	7,35	30
27	CLP 270 AO	Anodized	Gold	7,35	30

Clip and base to be order separately in the standard version 2,70 m

multiclip >> CLP270 in High resistance Wood Laminated Aluminum

B = mm	Art.	Finish	Variant	€ / m	pc ■
27	CLP 270 AC	Wood effect	Maple	13,29	30
27	CLP 270 CI	Wood effect	Cherry	13,29	30
27	CLP 270 FA	Wood effect	Beechwood	13,29	30
27	CLP 270 NC	Wood effect	Light Walnut	13,29	30
27	CLP 270 NS	Wood effect	Dark Walnut	13,29	30
27	CLP 270 RO	Wood effect	Oak	13,29	30
27	CLP 270 RD	Wood effect	Decapè Oak	16,15	30
27	CLP 270 RG	Wood effect	Grey Oak	16,15	30
27	CLP 270 RS	Wood effect	Bleached	13,29	30
27	CLP 270 RW	Wood effect	Wengè Oak	16,15	30
27	CLP 270 WE	Wood effect	Wengè	13,29	30

Clip and base to be order separately in the standard version 2,70 m



multiclip CLP 270 AS

multiclip - 6 to 20 mm

floor covering

✘ For quantities below 20 pcs 10% price increase applied.

Individually wrapped



Length: 2,70 meters

The Multiclip system is ideal to compensate floor thicknesses of 4 to 6 mm (±1.5 mm).

The Base and Clip system is also compatible with CLG370, CLF450 and CLF490.

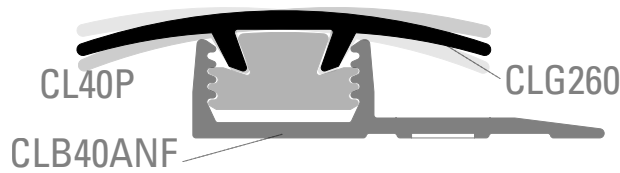

The Multiclip system for LVT floors is composed of a pre-drilled base (CLB 40 ANF), a clip (CL 40 P) and profiles (CLG 260, CLP 240, CLF 320) in 14 finishes. Used as joint or end profiles to compensate level differences from 4 to 6 mm. The combination between the clip system and the symmetrical shape of the CLG 260 profile allows movement which compensates level differences of up 1.5 mm.

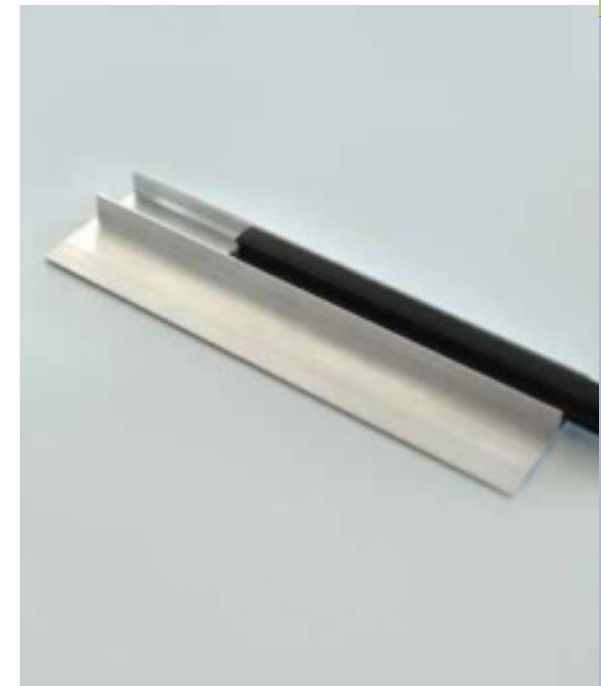

CLB40 + CL40

Length: 2,70 meters



multiclip LVT >> CL in Synthetic Resin

H = mm	Art.	Finish	€/ m	pc ■
4	CL 40 P	Synthetic Resin	1,58	200

multiclip LVT >> CLB Drilled fixing base in in Natural Aluminum

H = mm	Art.	Finish	Variant	€/ m	pc ■
4	CLB 40 ANF	Natural	Drilled	3,26	10

Length: 2,70 meters

SELFLINE/KIT PRE-CUT
0,90 m + €/m 8,44

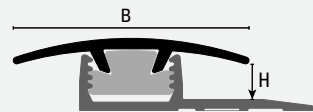

CLG 260

H = 4 to 6 mm

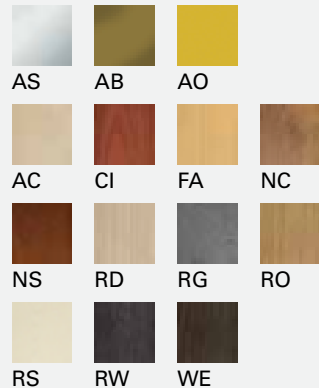

multiclip LVT >> CLG260 in Anodized Aluminum

B = mm	Art.	Finish	Variant	€/ m	pc ■
26	CLG 260 AS	Anodized	Silver	3,41	40
26	CLG 260 AB	Anodized	Bronze	3,41	40
26	CLG 260 AO	Anodized	Gold	3,41	40

Clip and base to be order separately in the standard version 2,70 m

☑ Ideal for vinyl floors (LVT)

multiclip LVT >> CLG260 in High resistance Wood Laminated Aluminum

B = mm	Art.	Finish	Variant	€/ m	pc ■
26	CLG 260 AC	Wood effect	Maple	12,92	40
26	CLG 260 CI	Wood effect	Cherry	12,92	40
26	CLG 260 FA	Wood effect	Beechwood	12,92	40
26	CLG 260 NC	Wood effect	Light Walnut	12,92	40
26	CLG 260 NS	Wood effect	Dark Walnut	12,92	40
26	CLG 260 RO	Wood effect	Oak	12,92	40
26	CLG 260 RD	Wood effect	Decapè Oak	12,92	40
26	CLG 260 RG	Wood effect	Grey Oak	12,92	40
26	CLG 260 RS	Wood effect	Bleached	12,92	40
26	CLG 260 RW	Wood effect	Wengè Oak	12,92	40
26	CLG 260 WE	Wood effect	Wengè	12,92	40

Clip and base to be order separately in the standard version 2,70 m

☑ Ideal for vinyl floors (LVT)



multiclip LVT CLG 260 AS

The images are inserted purely for illustrative purposes

☒ For quantities below 20 pcs 10% price increase applied.
☑ Individually wrapped

☑ Profile available in a pre-cut version



Length: 2,70 meters

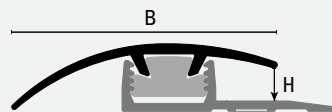

CLF 320

H = 4 to 6 mm

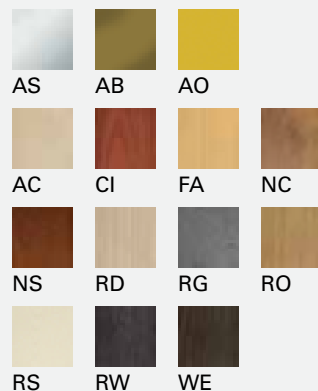

multiclip LVT >> CLF320 in Anodized Aluminum

	B = mm	Art.	Finish	Variant	€ / m	pc ■
	32	CLF 320 AS	Anodized	Silver	3,88	40
	32	CLF 320 AB	Anodized	Bronze	3,88	40
	32	CLF 320 AO	Anodized	Gold	3,88	40

Clip and base to be order separately in the standard version 2,70 m

Ideal for vinyl floors (LVT)

multiclip LVT >> CLF320 in High resistance Wood Laminated Aluminum

	B = mm	Art.	Finish	Variant	€ / m	pc ■
	32	CLF 320 AC	Wood effect	Maple	13,35	40
	32	CLF 320 CI	Wood effect	Cherry	13,35	40
	32	CLF 320 FA	Wood effect	Beechwood	13,35	40
	32	CLF 320 NC	Wood effect	Light Walnut	13,35	40
	32	CLF 320 NS	Wood effect	Dark Walnut	13,35	40
	32	CLF 320 RO	Wood effect	Oak	13,35	40
	32	CLF 320 RD	Wood effect	Decapè Oak	13,35	40
	32	CLF 320 RG	Wood effect	Grey Oak	13,35	40
	32	CLF 320 RS	Wood effect	Bleached	13,35	40
	32	CLF 320 RW	Wood effect	Wengè Oak	13,35	40
	32	CLF 320 WE	Wood effect	Wengè	13,35	40

Clip and base to be order separately in the standard version 2,70 m

Ideal for vinyl floors (LVT)



multiclip LVT CLF 320 AS

Length: 2,70 meters

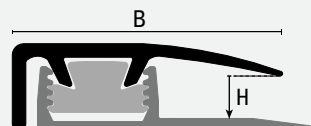

CLP 240

H = 4 to 6 mm

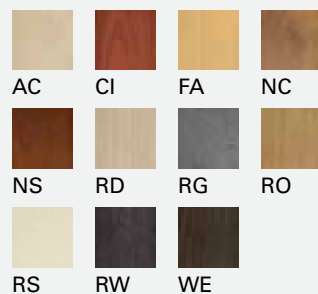

multiclip LVT >> CLP240 in Anodized Aluminum

	B = mm	Art.	Finish	Variant	€ / m	pc ■
	24	CLP 240 AS	Anodized	Silver	3,94	40
	24	CLP 240 AB	Anodized	Bronze	3,94	40
	24	CLP 240 AO	Anodized	Gold	3,94	40

Clip and base to be order separately in the standard version 2,70 m

Ideal for vinyl floors (LVT)

multiclip LVT >> CLP240 in High resistance Wood Laminated Aluminum

	B = mm	Art.	Finish	Variant	€ / m	pc ■
	24	CLP 240 AC	Wood effect	Maple	13,35	40
	24	CLP 240 CI	Wood effect	Cherry	13,35	40
	24	CLP 240 FA	Wood effect	Beechwood	13,35	40
	24	CLP 240 NC	Wood effect	Light Walnut	13,35	40
	24	CLP 240 NS	Wood effect	Dark Walnut	13,35	40
	24	CLP 240 RO	Wood effect	Oak	13,35	40
	24	CLP 240 RD	Wood effect	Decapè Oak	13,35	40
	24	CLP 240 RG	Wood effect	Grey Oak	13,35	40
	24	CLP 240 RS	Wood effect	Bleached	13,35	40
	24	CLP 240 RW	Wood effect	Wengè Oak	13,35	40
	24	CLP 240 WE	Wood effect	Wengè	13,35	40

Clip and base to be order separately in the standard version 2,70 m

Ideal for vinyl floors (LVT)



multiclip LVT CLP 240 AS

multiclip lvt 4 to 6 mm - lvt

floor covering

The images are inserted purely for illustrative purposes

For quantities below 20 pcs 10% price increase applied.

Individually wrapped

Length: 2,70 meters

SELFLINE-T/PRE-CUT
MULTIFIX including 6 pcs/m
0,90 and 1,35 m + €/m 2,50

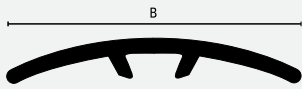

CLG 300

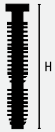

CLX 45
set of 6 pcs/m

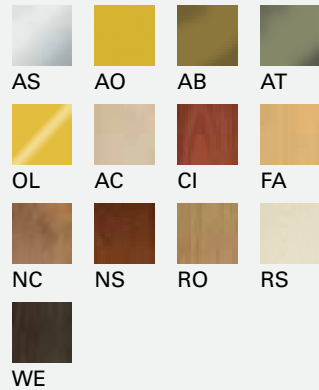

WE
The images are inserted purely for illustrative purposes

multifix >> CLG300 in Anodized Aluminum

	B = mm	Art.		Finish	Variant	€/ m	pc ■
⊗	30	CLG	300 AS	Anodized	Silver	5,41	40 ⊗
⊗	30	CLG	300 AO	Anodized	Gold	5,41	40 ⊗
⊗	30	CLG	300 AB	Anodized	Bronze	5,41	40 ⊗
new ⊗	30	CLG	300 AT	Anodized	Titan	11,36	40 ⊗

Dowels to be order separately in the standard version 2,70m.

multifix >> CLG300 in Wood Effect Aluminum

	B = mm	Art.		Finish	Variant	€/ m	pc ■
⊗	30	CLG	300 RS	Wood effect	Bleached	11,24	40 ⊗
⊗	30	CLG	300 AC	Wood effect	Maple	11,24	40 ⊗
⊗	30	CLG	300 FA	Wood effect	Beechwood	11,24	40 ⊗
⊗	30	CLG	300 RO	Wood effect	Oak	11,24	40 ⊗
⊗	30	CLG	300 CI	Wood effect	Cherry	11,24	40 ⊗
⊗	30	CLG	300 NC	Wood effect	Light Walnut	11,24	40 ⊗
⊗	30	CLG	300 NS	Wood effect	Dark Walnut	11,24	40 ⊗
⊗	30	CLG	300 WE	Wood effect	Wengè	11,24	40 ⊗

Dowels to be order separately in the standard version 2,70m.

multifix >> CLG300 in Polished Brass

	B = mm	Art.		Finish	€/ m	pc ■
⊗	30	CLG	300 OL	Polished	15,01	10 ⊗

Profile protected with a removable film. Clip and base to be order separately in the standard version 2,70m.

multifix >> CLX Iternative installation with dowels for art. CLG 300 - CLG 370 - CLF 450

	H = mm	Art.		Finish	€/ set	set ■
	45	CLX	45	Nylon	1,47	6

Suggested quantity: 5 dowels for meters. 6 pcs per set.



Multifix



- + Post installation
- + Fast and accurate
- + DIY



multifix

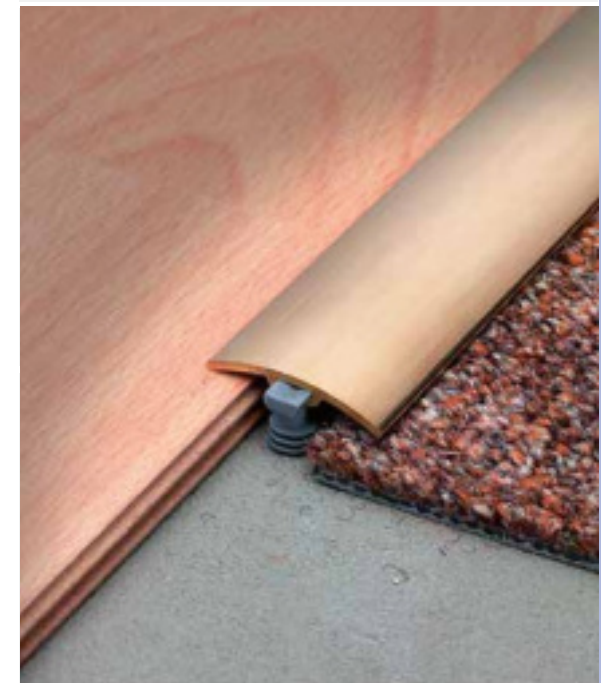

multifix CLG 300 OL

⊗ For quantities below 20 pcs 10% price increase applied.
⊗ Individually wrapped

⊗ Profile available in a pre-cut version

Length: 2,70 meters

- SELFLINE-A/KIT PRE-CUT
0,90 and 1,35 m + €/m 1,23
- SELFLINE-F/KIT PRE-CUT
0,90 and 1,35 m + €/m 1,52

5 + 5 x 0,90 m
7 + 7 x 1,35 m

screws + dowels

(Not included in the packaging)

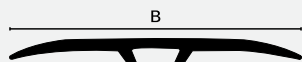

CLG 370

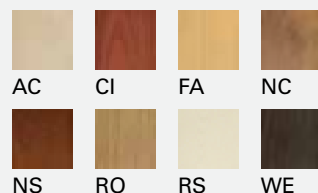

The images are inserted purely for illustrative purposes

multicover >> CLG370 in Wood Effect Aluminum - Self-Adhesive

	B = mm	Art.		Finish	Variant	€/ m	pc ■
⊗	37	CLG	370 RSA	Wood effect	Whitened Oak Adhesive	13,83	30
⊗	37	CLG	370 ACA	Wood effect	Maple - Self-Adhesive	13,83	30
⊗	37	CLG	370 FAA	Wood effect	Beechwood - Self-Adh.	13,83	30
⊗	37	CLG	370 ROA	Wood effect	Oak - Self-Adhesive	13,83	30
⊗	37	CLG	370 CIA	Wood effect	Cherry - Self-Adhesive	13,83	30
⊗	37	CLG	370 NCA	Wood effect	Light Walnut -Self-Adh.	13,83	30
⊗	37	CLG	370 NSA	Wood effect	Dark Walnut -Self-Adh.	13,83	30
⊗	37	CLG	370 WEA	Wood effect	Wengè - Self-Adhesive	13,83	30

multicover >> CLG370 in Wood Effect Aluminum - Drilled

	B = mm	Art.		Finish	Variant	€/ m	pc ■
⊗	37	CLG	370 RSF	Wood effect	Bleached Drilled	12,33	30
⊗	37	CLG	370 ACF	Wood effect	Maple Drilled	12,33	30
⊗	37	CLG	370 FAF	Wood effect	Beechwood Drilled	12,33	30
⊗	37	CLG	370 ROF	Wood effect	Oak Drilled	12,33	30
⊗	37	CLG	370 CIF	Wood effect	Cherry Drilled	12,33	30
⊗	37	CLG	370 NCF	Wood effect	Light Walnut Drilled	12,33	30
⊗	37	CLG	370 NSF	Wood effect	Dark Walnut - Drilled	12,33	30
⊗	37	CLG	370 WEF	Wood effect	Wengè Drilled	12,33	30



multicover CLG 370 CIA

Length: 2,70 meters

- SELFLINE-A/KIT PRE-CUT
0,90 and 1,35 m + €/m 1,23
- SELFLINE-F/KIT PRE-CUT
0,90 and 1,35 m + €/m 1,52

5 + 5 x 0,90 m
7 + 7 x 1,35 m

screws + dowels

(Not included in the packaging)

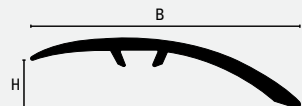

CLF 450

H for thicknesses from 6 to 11 mm

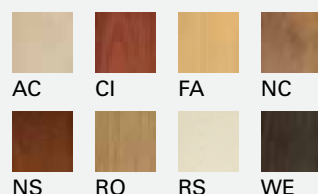

The images are inserted purely for illustrative purposes

multicover >> CLF450 in Wood Effect Aluminum - Self-Adhesive

	B = mm	Art.		Finish	Variant	€/ m	pc ■
⊗	45	CLF	450 RSA	Wood effect	Whitened Oak Adhesive	15,32	30
⊗	45	CLF	450 ACA	Wood effect	Maple - Self-Adhesive	15,32	30
⊗	45	CLF	450 FAA	Wood effect	Beechwood - Self-Adh.	15,32	30
⊗	45	CLF	450 ROA	Wood effect	Oak - Self-Adhesive	15,32	30
⊗	45	CLF	450 CIA	Wood effect	Cherry - Self-Adhesive	15,32	30
⊗	45	CLF	450 NCA	Wood effect	Light Walnut -Self-Adh.	15,32	30
⊗	45	CLF	450 NSA	Wood effect	Dark Walnut -Self-Adh.	15,32	30
⊗	45	CLF	450 WEA	Wood effect	Wengè - Self-Adhesive	15,32	30

multicover >> CLF450 in Wood Effect Aluminum - Drilled

	B = mm	Art.		Finish	Variant	€/ m	pc ■
⊗	45	CLF	450 RSF	Wood effect	Bleached Drilled	13,90	30
⊗	45	CLF	450 ACF	Wood effect	Maple Drilled	13,90	30
⊗	45	CLF	450 FAF	Wood effect	Beechwood Drilled	13,90	30
⊗	45	CLF	450 ROF	Wood effect	Oak Drilled	13,90	30
⊗	45	CLF	450 CIF	Wood effect	Cherry Drilled	13,90	30
⊗	45	CLF	450 NCF	Wood effect	Light Walnut Drilled	13,90	30
⊗	45	CLF	450 NSF	Wood effect	Dark Walnut - Drilled	13,90	30
⊗	45	CLF	450 WEF	Wood effect	Wengè Drilled	13,90	30



multicover CLF 450 ACA

⊗ For quantities below 20 pcs 10% price increase applied.

⊞ Individually wrapped

⊞ Profile available in a pre-cut version



Length: 2,70 meters

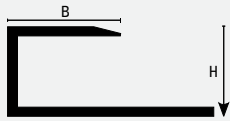

LT

B = 17 mm

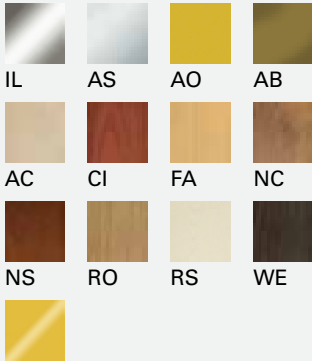

OL

The images are inserted purely for illustrative purposes

woodtec >> LT in Stainless Steel AISI 304 - DIN 1.4301 Polished

H = mm	Art.	Finish	€/ m	pc ■
10	LT 100 ILN	Polished	11,90	10
15	LT 150 ILN	Polished	13,02	10
22	LT 220 ILN	Polished	14,14	10

Thickness 10/10 - protected with a removable film.

woodtec >> LT in Anodized Aluminum

H = mm	Art.	Finish	Variant	€/ m	pc ■
7	LT 70 ASN	Anodized	Silver	6,03	20
9	LT 90 ASN	Anodized	Silver	6,28	20
10,2	LT 100 ASN	Anodized	Silver	6,47	20
13	LT 130 ASN	Anodized	Silver	6,66	20
15	LT 150 ASN	Anodized	Silver	6,95	20
7	LT 70 AON	Anodized	Gold	6,06	20
9	LT 90 AON	Anodized	Gold	6,32	20
10,2	LT 100 AON	Anodized	Gold	6,50	20
13	LT 130 AON	Anodized	Gold	6,69	20
15	LT 150 AON	Anodized	Gold	7,00	20
7	LT 70 ABN	Anodized	Bronze	6,03	20
9	LT 90 ABN	Anodized	Bronze	6,28	20
10,2	LT 100 ABN	Anodized	Bronze	6,47	20
13	LT 130 ABN	Anodized	Bronze	6,66	20
15	LT 150 ABN	Anodized	Bronze	6,95	20

woodtec >> LT in Wood Effect Aluminum

H = mm	Art.	Finish	Variant	€/ m	pc ■
9	LT 90 RSN	Wood effect	Bleached	9,81	20
9	LT 90 ACN	Wood effect	Maple	9,81	20
9	LT 90 FAN	Wood effect	Beechwood	9,81	20
9	LT 90 RON	Wood effect	Oak	9,86	20
9	LT 90 CIN	Wood effect	Cherry	9,77	20
9	LT 90 NCN	Wood effect	Light Walnut	9,81	20
9	LT 90 NSN	Wood effect	Dark Walnut	9,81	20
9	LT 90 WEN	Wood effect	Wengé	9,81	20

woodtec >> LT in Polished Brass

H = mm	Art.	Finish	€/ m	pc ■
10	LT 100 OLN	Polished	15,18	10
15	LT 150 OLN	Polished	16,53	10
22	LT 220 OLN	Polished	18,00	10

Thickness 10/10 - protected with a removable film.

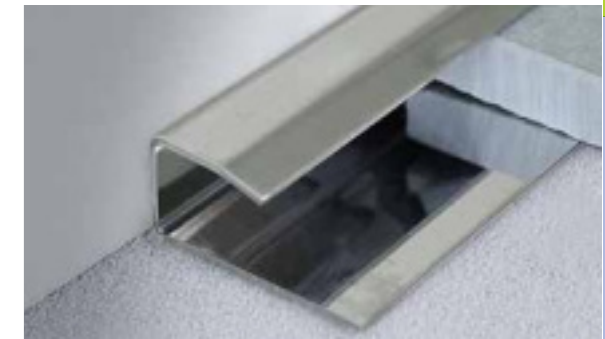

woodtec LT - ILN

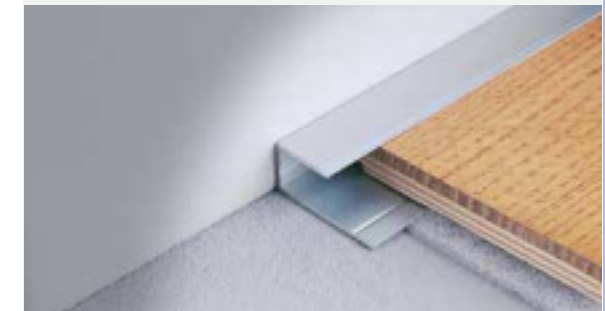

woodtec LT - AS



woodtec LT - AC



woodtec LT - NS

☒ For quantities below 20 pcs 10% price increase applied.
 ☒ Individually wrapped



Length: 2,70 meters

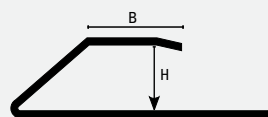

LP

B = 16 mm



IL OL

The images are inserted purely for illustrative purposes

woodtec >> LP in Stainless Steel AISI 304 - DIN 1.4301 Polished

H = mm	Art.			Finish	€ / m	pc ■
10	LP	100	ILN	Polished	13,63	10
15	LP	150	ILN	Polished	16,84	10
22	LP	220	ILN	Polished	20,87	10

Thickness 10/10 - protected with a removable film.

woodtec >> LP in Polished Brass

H = mm	Art.			Finish	€ / m	pc ■
10	LP	100	OLN	Polished	18,72	10
15	LP	150	OLN	Polished	21,84	10
22	LP	220	OLN	Polished	26,20	10

Thickness 10/10 - protected with a removable film.

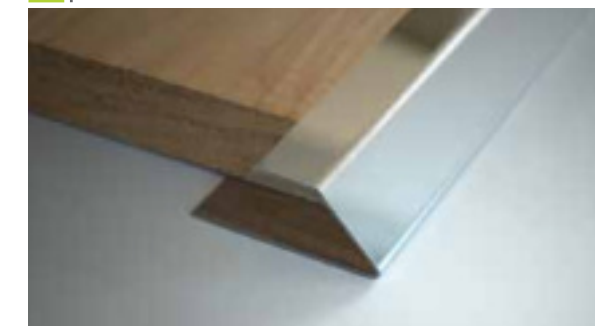

woodtec LP-IL



woodtec LP-OL

Length: 2,70 meters

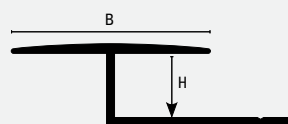

LG - A

B = 30 mm



AS AO AB AT

The images are inserted purely for illustrative purposes

woodtec >> LG in Anodized Aluminum

H = mm	Art.			Finish	Variant	€ / m	pc ■	
9	LG	90	ASN	Anodized	Silver	7,32	20	
10,2	LG	100	ASN	Anodized	Silver	7,47	20	
13	LG	130	ASN	Anodized	Silver	7,78	20	
15	LG	150	ASN	Anodized	Silver	7,91	20	
9	LG	90	AON	Anodized	Gold	7,37	20	
10,2	LG	100	AON	Anodized	Gold	7,52	20	
13	LG	130	AON	Anodized	Gold	7,82	20	
15	LG	150	AON	Anodized	Gold	7,95	20	
9	LG	90	ABN	Anodized	Bronze	7,32	20	
10,2	LG	100	ABN	Anodized	Bronze	7,47	20	
13	LG	130	ABN	Anodized	Bronze	7,78	20	
15	LG	150	ABN	Anodized	Bronze	7,91	20	
<small>new</small>	13	LG	130	AT	Anodized	Titan	15,05	20



woodtec LG

Length: 2,70 meters

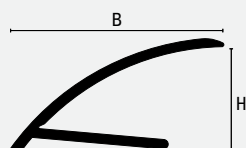

LS 30 A

H for thicknesses from 7 to 13 mm



AS AO AB

The images are inserted purely for illustrative purposes

woodtec >> LS in Anodized Aluminum - Self-Adhesive

B = mm	Art.			Finish	Variant	€ / m	pc ■
30	LS	30	ASA	Anodized	Silver Self-Adhesive	7,61	20
30	LS	30	AOA	Anodized	Gold Self-Adhesive	7,61	20
30	LS	30	ABA	Anodized	Bronze Self-Adhesive	7,61	20

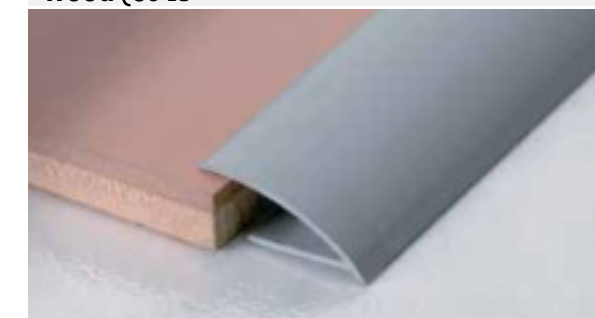

vario tec LS

✘ For quantities below 20 pcs 10% price increase applied.

Individually wrapped



Length: 2,70 meters

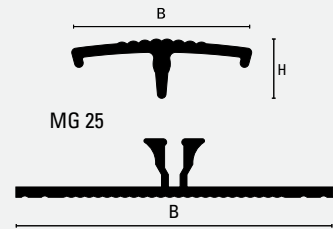

The images are inserted purely for illustrative purposes

carpetec >> MGB Fixing base in Natural Aluminum

B = mm	Art.	Finish	Variant	€/ m	pc ■
46	MGB 25 ANF	Natural	Drilled	5,95	20
46	MGB 25 AND	Natural	Toothed	6,92	20

carpetec >> MG in Anodized Aluminum - Top

B = mm	Art.	Finish	Variant	€/ m	pc ■
25	MG 25 ASN	Anodized	Silver	5,55	20
25	MG 25 AON	Anodized	Gold	5,55	20
25	MG 25 ABN	Anodized	Bronze	5,55	20

Base to be ordered separately.

carpetec >> MG in Polished Brass -Top

B = mm	Art.	Finish	€/ m	pc ■
25	MG 25 OLN	Polished	20,54	10

Base to be ordered separately.



carpetec MG

Length: 2,70 meters

☒ SELFLINE-A/KIT PRE-CUT

0,90 e 1,35 m + €/m 1,23

☒ SELFLINE-F/KIT PRE-CUT

0,90 e 1,35 m + €/m 1,52

5 + 5 x 0,90 m
7 + 7 x 1,35 m

screws + dowels

(Not included in the packaging)

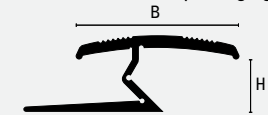

MP 28 A
H = 9 mm

carpetec >> MP in Anodized Aluminum - Self-Adhesive

B = mm	Art.	Finish	Variant	€/ m	pc ■
☒ 28	MP 28 ASA	Anodized	Silver Self-Adhesive	8,64	20
☒ 28	MP 28 AOA	Anodized	Gold Self-Adhesive	8,64	20
☒ 28	MP 28 ABA	Anodized	Bronze Self-Adhesive	8,64	20

carpetec >> MP28 in anodized aluminum drilled

B = mm	Art.	Finish	Variant	€/ m	pc ■
☒ 28	MP 28 ASF	Anodized	Silver Drilled	7,18	10
☒ 28	MP 28 AOF	Anodized	Gold Drilled	7,18	10
☒ 28	MP 28 ABF	Anodized	Bronze Drilled	7,18	10



carpetec MP

Length: 2,70 meters

☒ SELFLINE-A/KIT PRE-CUT

0,90 e 1,35 m + €/m 1,20

5 + 5 x 0,90 m
7 + 7 x 1,35 m

screws + dowels

(Not included in the packaging)

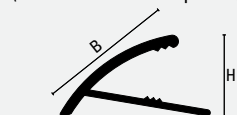

MA 24 A
H = 16 mm

carpetec >> MA in Anodized Aluminum - Self-Adhesive

B = mm	Art.	Finish	Variant	€/ m	pc ■
☒ 24	MA 24 ASA	Anodized	Silver Self-Adhesive	7,09	20
☒ 24	MA 24 AOA	Anodized	Gold Self-Adhesive	7,09	20
☒ 24	MA 24 ABA	Anodized	Bronze Self-Adhesive	7,09	20



carpetec MA-ASA

☒ For quantities below 20 pcs 10% price increase applied.

☒ Individually wrapped

☒ Profile available in a pre-cut version

junct. and edge for wooden floors

floor covering



Length: 2,70 meters

- SELFLINE-A/KIT PRE-CUT
0,90 and 1,35 m + €/m 1,23
- SELFLINE-F/KIT PRE-CUT
0,90 and 1,35 m + €/m 1,52

5 + 5 x 0,90 m
7 + 7 x 1,35 m

screws + dowels

non tradotto

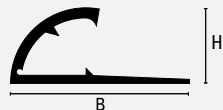

MS 26

H = 13 mm

carpetec >> MS in Anodized Aluminum - Self-Adhesive

	B = mm	Art.			Finish	Variant	€/ m	pc ■
⊗	26	MS	26	ASA	Anodized	Silver - Self-Adhesive	6,25	20
⊗	26	MS	26	AOA	Anodized	Gold - Self-Adhesive	6,25	20
⊗	26	MS	26	ABA	Anodized	Bronze - Self-Adh.	6,25	20

carpetec >> MP26 in anodized aluminum drilled

	B = mm	Art.			Finish	Variant	€/ m	pc ■
⊗	26	MS	26	ASF	Anodized	Silver Drilled	4,79	10
⊗	26	MS	26	AOF	Anodized	Gold Drilled	4,79	10
⊗	26	MS	26	ABF	Anodized	Bronze Drilled	4,79	10

carpetec >> MS in Polished Brass

	B = mm	Art.			Finish	€/ m	pc ■
⊗	26	MS	26	OLN	Polished	16,28	10



carpetec MS



carpetec MD 43 ABD

Length: 2,70 meters

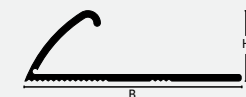

MD 43 A

H = 14 mm

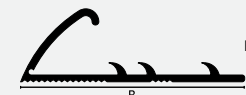

MD 43 A

H = 14 mm

carpetec >> MD in Anodized Aluminum - Drilled

	B = mm	Art.			Finish	Variant	€/ m	pc ■
	43	MD	43	ASF	Anodized	Silver Drilled	6,47	10
	43	MD	43	AOF	Anodized	Gold Drilled	6,47	10
	43	MD	43	ABF	Anodized	Bronze Drilled	6,47	10

carpetec >> MD43 in anodized aluminum - with hooks

	B = mm	Art.			Finish	Variant	€/ m	pc ■
	43	MD	43	ASD	Anodized	Silver - Toothed	8,29	10
	43	MD	43	AOD	Anodized	Gold - Toothed	8,29	10
	43	MD	43	ABD	Anodized	Bronze - Toothed	8,29	10



multicurve CGD 300 P51

Length: 2,50 m

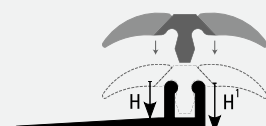

CBD - P

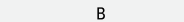

CGD 300 P

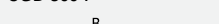

CFD 390 P

multicurve >> CBD - BASE Bendable Perforated Base in Synthetic Resin

	H/H1 mm	Art.			Finish	Variant	€/ m	pc ■
	6/8	CBD	60	P	Synthetic Resin	Drilled	13,26	20
	9/11	CBD	90	P	Synthetic Resin	Drilled	13,99	20
	12/14	CBD	120	P	Synthetic Resin	Drilled	14,70	20

multicurve >> CGD - TOP in Bendable Synthetic Resin

	B = mm	Art.			Finish	Variant	€/ m	pc ■
	30	CGD	300	P23	Synthetic Resin	Grey	6,64	20
	30	CGD	300	P51	Synthetic Resin	Black	6,64	20

Base to be ordered separately according to the required height. R1 400mm, R2 400mm.

multicurve >> CFD - TOP Bendable Synthetic Resin

	B = mm	Art.			Finish	Variant	€/ m	pc ■
	39	CFD	390	P23	Synthetic Resin	Grey	11,38	20
	39	CFD	390	P51	Synthetic Resin	Black	11,38	20

Base to be ordered separately only base to be used CDB 60 P. Concave curve 900mm, convex curve 400 mm.



multicurve CFD 390 P23

⊗ For quantities below 20 pcs 10% price increase applied.

Individually wrapped

⊗ Profile available in a pre-cut version



Length: 2,70 meters

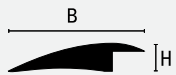

AP
H = 2,5 mm



AS OL

The images are inserted purely for illustrative purposes

linotec >> AP in Anodized Aluminum - Self-Adhesive

B = mm	Art.	Finish	Variant	€ / m	pc ■
17	AP 17 ASA	Anodized	Silver Self-Adhesive	5,44	40

linotec >> AP in Anodized Aluminum - not Adhesive

B = mm	Art.	Finish	Variant	€ / m	pc ■
17	AP 17 ASN	Anodized	Silver - not Self-Adhesive	3,94	20

linotec >> AP in Brass - Self-Adhesive

B = mm	Art.	Finish	Variant	€ / m	pc ■
19	AP 19 OLA	Polished	Self-Adhesive	15,79	20

Profile protected with a removable film.

linotec >> AP in Brass - not Adhesive

B = mm	Art.	Finish	Variant	€ / m	pc ■
19	AP 19 OLN	Polished	not Adhesive	14,03	10

Profile protected with a removable film.

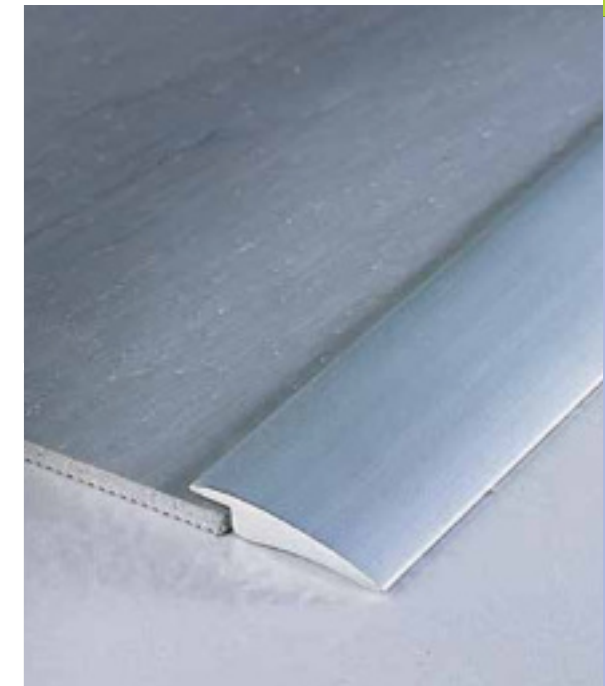

linotec AP 17 ASN

Length: 2,70 meters

SELFLINE/KIT PRE-CUT
0,90 and 1,35 m + €/m 1,20

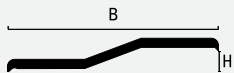

AV 30 OL
H for thicknesses from 2 to 3 mm



OL

The images are inserted purely for illustrative purposes

linotec >> AV in Brass - Self-Adhesive

B = mm	Art.	Finish	Variant	€ / m	pc ■
30	AV 30 OLA	Polished	Self-Adhesive	9,31	15

Thickness 10/10 - protected with a removable film.

linotec >> AV in Brass - not Adhesive

B = mm	Art.	Finish	Variant	€ / m	pc ■
30	AV 30 OLN	Polished	not Adhesive	7,56	10

Thickness 10/10 - protected with a removable film.

For quantities below 20 pcs 10% price increase applied.

Individually wrapped

Profile available in a pre-cut version



entrytec BU

Length: 2,70 meters

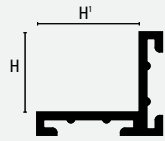

BU 18/23



BUS / BUI

entrytec >> BU Reversible profile in Aluminum entrance mat framing

H/H1 = mm	Art.	Finish	Variant	€ / m	pc ■
18/23	BU 18/23 AS	Anodized	Silver	9,67	50

entrytec >> BU ON reversible profiles for entrance mats in brass

H/H1 = mm	Art.	Finish	€ / m	pc ■
18/23	BU 18/23 ON	Natural	26,47	10

entrytec >> Fixing clamp - Brass Natural

Art.	Finish	Variant	€ / pc	pc ■
BUS 20 ON	Natural		3,03	10

entrytec >> Internal corners fixing bracket - Amuninum Natural

Art.	Finish	Variant	€ / pc	pc ■
BUI 20 AN	Natural		1,47	10

Length: 2,70 meters



STC 30 0*

wire cover » in Brass self-adhesive

B = mm	Art.	Finish	Variant	€ / m	pc ■
31	STC 30 OLA	Polished	Self-Adhesive	18,29	10

wire cover >> stc in brass without adhesive

B = mm	Art.	Finish	Variant	€ / m	pc ■
31	STC 30 OLN	Polished	not Adhesive	16,55	10

*For quantities below 20 pcs 10% price increase applied.



Stair nosing

Safety and appearance are of utmost importance when designing staircases, and the right choice in profiling can make all the difference. PROFILITEC proposes a complete line of technical yet aesthetic nosing profiles suitable for all flooring applications. Designed with safety in mind, our range of nosing profiles can be used for renovations in private and public buildings. Non-slip thermoplastic rubber inserts and tread grooving contribute to the cutting-edge detailing which distinguishes PROFILITEC profiles.

Article	Code	Use	Pag.
Stairtec	FS	tiled steps	44
Trimtec	TR	multipurpose	44
Stairtec	FSL	tiled steps	45
Stairtec	FSF	tiled steps	46
Stairtec	FI	tiled steps	46
Stairtec	FW	tiled steps	47
Filojolly	RJF	invisible junction. mosaic	47
Stairtec	SR	tiled steps	47
Stairtec	SVT	technical for LVT	48
Stairtec	FVT	technical for LVT	48
Stairtec	FL-IL	decorative for ceramic tiles	48
Bordertec	BSJ	modular for terraces	48
Stairtec	FL-AS	decorative for ceramic tiles	49
Roundtec	RD	joints for ceramic tiles	49
Roundjolly	RJ	joints for ceramic tiles	50
Squarejolly	SJ	tiled steps	52
Squarejolly	SJR	with Resin-Grip	54
Squarejolly	SJM	ultra-thin tiles	54
Stairtec	FO-IL	techn. for wood/ceramic	54
Stairtec	FO-AS	techn. for wood/ceramic	55
Stairtec	SWP	aluminum safety step	55
Stairtec	SWR	aluminum safety step	55
Stairtec	SW	aluminum safety step	55
Stairtec	SWH	carborundum Strip Walk	56
Stairtec	SI	aluminum safety step	56
Stairtec	AE	ribbed on existing floors	56
Stairtec	SE	ribbed on existing floors	57
Stairtec	SA	on existing surfaces	57
Stairtec	SL	on existing surfaces	58
Stairtec	SC	vynil. moquettes	59
Stairtec	SM	moquettes	59
Multiclip	CLS	stairnosing with multiclip system	60
LED	LES LED	profile for steps	61
Rod	TTR/TTO	stair carpets	62





Length: 2,70 meters

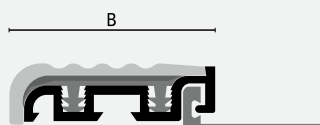

FS30A + TR



FS product is certified R10. Anti-slip properties. In accordance with DIN 51130 (06/2004).

A23= AN + P23

A32= AN + P32

A51= AN + P51



P23 P32 P51

The images are inserted purely for illustrative purposes

stairtec >> FS in Natural Aluminum

B = mm	Art.	Finish	Variant	€ / m	pc ■
30	FS 30 A23	Natural	Cement Grey	11,96	10
30	FS 30 A32	Natural	Dark Beige	11,96	10
30	FS 30 A51	Natural	Black Graphite	11,96	10

Art. FS 30 A Supplied with anti-slip synthetic rubber to be assembled with TR to be ordered separately (tile thickness reduced by 2 mm - 3/32").

trimtec >> TR in Natural Aluminum to be assembled with FS

H = mm	Art.	Finish	€ / m	pc ■
4,5	TR 45 AN	Natural	2,85	40
6	TR 60 AN	Natural	2,90	40
8	TR 80 AN	Natural	2,99	40
10	TR 100 AN	Natural	3,15	40
11	TR 110 AN	Natural	3,33	40
12,5	TR 125 AN	Natural	3,51	40
15	TR 150 AN	Natural	3,87	40
17,5	TR 175 AN	Natural	4,23	40
20	TR 200 AN	Natural	4,51	40
22,5	TR 225 AN	Natural	4,78	40

stairtec >> FSI Rubber Insert

B = mm	Art.	Finish	€ / m	pc ■
30	FSI 30 P23	Cement Grey	4,73	70
30	FSI 30 P32	Dark Beige	4,73	70
30	FSI 30 P51	Black Graphite	4,73	70

stairtec >> FST End cap in PVC

H = mm	Art.	Finish	Variant	€ / set	set ■
8	FST 80 P23	PVC	Cement Grey	4,54	5 pcs
10	FST 100 P23	PVC	Cement Grey	4,54	5 pcs
12,5	FST 125 P23	PVC	Cement Grey	4,54	5 pcs
8	FST 80 P32	PVC	Dark Beige	4,54	5 pcs
10	FST 100 P32	PVC	Dark Beige	4,54	5 pcs
12,5	FST 125 P32	PVC	Dark Beige	4,54	5 pcs
8	FST 80 P51	PVC	Black Graphite	4,54	5 pcs
10	FST 100 P51	PVC	Black Graphite	4,54	5 pcs
12,5	FST 125 P51	PVC	Black Graphite	4,54	5 pcs

End Cap (left or right). Code: FST-P**/DX or FST-P**/SX. Code example: FST100P23/DX or FST100P23/SX



stairtec FS 30 A51

✘ For quantities below 20 pcs 10% price increase applied.

Length: 2,70 meters

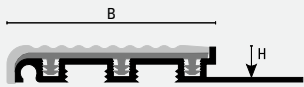

FSL-A

B = 55 mm



FSA 50 AS

A23= AN + P23

A32= AN + P32

A51= AN + P51



AS P23 P32 P51

The images are inserted purely for illustrative purposes

stairtec >> FSL in Natural Aluminum

H = mm	Art.	Finish	Variant	€ / m	pc ■
8	FSL 80 A23	Natural	Cement Grey	19,55	5
10	FSL 100 A23	Natural	Cement Grey	20,28	5
12,5	FSL 125 A23	Natural	Cement Grey	21,08	5
8	FSL 80 A32	Natural	Dark Beige	19,55	5
10	FSL 100 A32	Natural	Dark Beige	20,28	5
12,5	FSL 125 A32	Natural	Dark Beige	21,08	5
8	FSL 80 A51	Natural	Black Graphite	19,55	5
10	FSL 100 A51	Natural	Black Graphite	20,28	5
12,5	FSL 125 A51	Natural	Black Graphite	21,08	5

Art. FSL supplied with anti-slip insert already mounted.

stairtec >> FSA Riser cover in Anodized Aluminum for FSL

H = mm	Art.	Finish	Variant	€ / m	pc ■
50	FSA 50 AS	Anodized	Silver	6,35	10

stairtec >> FSLI Rubber Insert Spare part for FSL

B = mm	Art.	Finish	€ / m	pc ■
55	FSLI 55 P23	Cement Grey	6,19	50
55	FSLI 55 P32	Dark Beige	6,19	50
55	FSLI 55 P51	Black Graphite	6,19	50

stairtec >> FSLT End cap in PVC for FSL

H = mm	Art.	Finish	Variant	€ / set	set ■
8	FSLT 80 P23	PVC	Cement Grey	7,36	5 pcs
10	FSLT 10 P23	PVC	Cement Grey	7,36	5 pcs
12,5	FSLT 12 P23	PVC	Cement Grey	7,36	5 pcs
8	FSLT 80 P32	PVC	Dark Beige	7,36	5 pcs
10	FSLT 10 P32	PVC	Dark Beige	7,36	5 pcs
12,5	FSLT 12 P32	PVC	Dark Beige	7,36	5 pcs
8	FSLT 80 P51	PVC	Black Graphite	7,36	5 pcs
10	FSLT 10 P51	PVC	Black Graphite	7,36	5 pcs
12,5	FSLT 12 P51	PVC	Black Graphite	7,36	5 pcs

End Cap (left or right). Code:FSLT-P**/D or FSLT-P**/S. Code example: FSLT100P23/D or FSLT100P23/S



stairtec FSL-A51 + FSA 50 AS



FSLT 100 P*

☒ For quantities below 20 pcs 10% price increase applied.



Length: 2,70 meters

SELFLINE/KIT PRE-CUT
0,90 and 1,35 m + €/m 0,53



FSFA

B = 30 mm



FSF product is certified R10. Anti-slip properties. In accordance with DIN 51130 (06/2004).



P23 P32 P51 IL

The images are inserted purely for illustrative purposes

A23= AN + P23
A32= AN + P32
A51= AN + P51

stairtec >> FSF in Natural Aluminum

	H = mm	Art.	Finish	Variant	€/ m	pc ■
⊗	8	FSF 80 A23	Natural	Cement Grey	13,43	10
⊗	10	FSF 100 A23	Natural	Cement Grey	13,85	10
⊗	12,5	FSF 125 A23	Natural	Cement Grey	14,52	10
⊗	8	FSF 80 A32	Natural	Dark Beige	13,43	10
⊗	10	FSF 100 A32	Natural	Dark Beige	13,85	10
⊗	12,5	FSF 125 A32	Natural	Dark Beige	14,52	10
⊗	8	FSF 80 A51	Natural	Black Graphite	13,43	10
⊗	10	FSF 100 A51	Natural	Black Graphite	13,85	10
⊗	12,5	FSF 125 A51	Natural	Black Graphite	14,52	10

Art. FSF supplied with anti-slip insert already mounted.

stairtec >> FSFI Rubber Insert Spare part

	B = mm	Art.	Finish	€/ m	pc ■
	30	FSFI 30 P23	Cement Grey	4,73	70
	30	FSFI 30 P32	Dark Beige	4,73	70
	30	FSFI 30 P51	Black Graphite	4,73	70

stairtec >> FST End cap in PVC

	H = mm	Art.	Finish	Variant	€/ set	set ■
	8	FST 80 P23	PVC	Cement Grey	4,54	5 pcs
	10	FST 100 P23	PVC	Cement Grey	4,54	5 pcs
	12,5	FST 125 P23	PVC	Cement Grey	4,54	5 pcs
	8	FST 80 P32	PVC	Dark Beige	4,54	5 pcs
	10	FST 100 P32	PVC	Dark Beige	4,54	5 pcs
	12,5	FST 125 P32	PVC	Dark Beige	4,54	5 pcs
	8	FST 80 P51	PVC	Black Graphite	4,54	5 pcs
	10	FST 100 P51	PVC	Black Graphite	4,54	5 pcs
	12,5	FST 125 P51	PVC	Black Graphite	4,54	5 pcs

End Cap (left or right). Code: FST-P**/DX or FST-P**/SX. Code example: FST100P23/DX or FST100P23/SX



stair+tec FSF-A23



stair+tec FI - IL + SWH 19 C51

Length: 2,70 meters

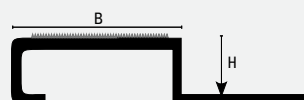

FI - IL

B = 27 mm



SWH product is certified R13. Anti-slip properties. According to standard DIN 51130 (06/2004).

stairtec >> FI in Stainless Steel AISI 304 - DIN 1.4301

	H = mm	Art.	Finish	€/ m	pc ■
	8	FI 80 IL	Polished	20,74	10
	10	FI 100 IL	Polished	21,59	10
	12,5	FI 125 IL	Polished	22,43	10

walktec >> SWH Carborundum self-adhesive "Strip Walk"

	H = mm	Art.	Finish	Variant	€/ roll	roll ■
	19x18.3	SWH 19 C51	Carborundum	Black in roll	33,02	1
	19x18.3	SWH 19 CF	Carborundum	Photoluminescent* in roll	105,84	1

Anti-slip insert has to be ordered separately.

stairtec >> FIT caps for FI in Stainless Steel AISI 304 DIN 1.4301

	H = mm	Art.	Finish	€/ set	set ■
	8	FIT 80 IS	Brushed	37,85	10
	10	FIT 100 IS	Brushed	37,85	10
	12,5	FIT 125 IS	Brushed	37,85	10

⊗ For quantities below 20 pcs 10% price increase applied.



Length: 2,70 meters

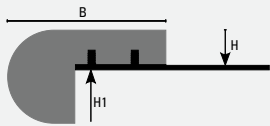

FW - RON
B = 46 mm
H1 = 16 mm

stairtec >> FW in Natural Oak

H = mm	Art.	Finish	Variant	€/ m	pc ■
10	FW 100 RON	Natural	Oak wood	41,08	6
12,5	FW 125 RON	Natural	Oak wood	43,44	6
15	FW 150 RON	Natural	Oak wood	45,46	6

Wooden stair nosing assembled with a perforated Aluminum base.



stairtec FW-ROn

Length: 2,70 meters

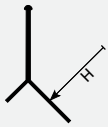

RJF - A

filojolly >> RJF in Anodized Aluminum

H = mm	Art.	Finish	Variant	€/ m	pc ■
20	RJF 200 AS	Anodized	Silver	7,90	40



filojolly RJF 200 AS

Length: 2,70 meters

- CURVELINE/BENDABLE
- Cod SR-ILD + €/m 3,41
- Cod SR-ASD + €/m 1,73
- Cod SR-OND + €/m 3,12

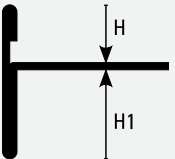

SR - I

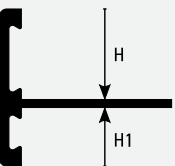

SR - A
SR - O



IL IS AS ON



OL

The images are inserted purely for illustrative purposes

stairtec >> SR in Stainless Steel AISI 304 - DIN 1.4301 - Reversible profile

H = mm	Art.	Finish	€/ m	pc ■
<input checked="" type="checkbox"/> 8/15	SR 8/15 IL	Polished	15,97	10
<input checked="" type="checkbox"/> 10/12,5	SR 10/12 IL	Polished	15,97	10

Protected with a removable film.

stairtec >> SR in Stainless Steel AISI 304 - DIN 1.4301 - Reversible profile

H = mm	Art.	Finish	€/ m	pc ■
8/15	SR 8/15 IS	Brushed	18,93	10
10/12,5	SR 10/12 IS	Brushed	18,93	10

Protected with a removable film.

stairtec >> SR in Anodized Aluminum - Reversible profile

H = mm	Art.	Finish	Variant	€/ m	pc ■
<input checked="" type="checkbox"/> 8/15	SR 8/15 AS	Anodized	Silver	8,06	10
<input checked="" type="checkbox"/> 10/12,5	SR 10/12 AS	Anodized	Silver	8,06	10

stairtec >> SR in Natural Brass- Reversible profile

H = mm	Art.	Finish	€/ m	pc ■
<input checked="" type="checkbox"/> 8/15	SR 8/15 ON	Natural	16,19	10
<input checked="" type="checkbox"/> 10/12,5	SR 10/12 ON	Natural	16,19	10

stairtec >> SR in Polished Brass - Reversible profile

H = mm	Art.	Finish	€/ m	pc ■
8/15	SR 8/15 OL	Polished	20,37	10
10/12,5	SR 10/12 OL	Polished	20,37	10

For quantities below 20 pcs 10% price increase applied.

Individually wrapped

Bendable with bending machine



stairtec SR-AS

tilled steps

stair nosing



Length: 2,70 meters

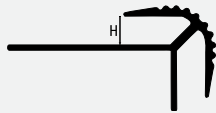

SVT 50 AS

stairtec >> SVT in Anodized Aluminum

	H = mm	Art.		Finish	Variant	€ / m	pc ■
	5	SVT	50 AS	Anodized	Silver	7,82	40

Ideal for vinyl floors (LVT)

Length: 2,70 meters

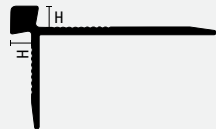

FVT 30 ASF

stairtec >> FVT in Anodized Aluminum

	H = mm	Art.		Finish	Variant	€ / m	pc ■
	3	FVT	30 ASF	Anodized	Silver Drilled	7,55	20

Ideal for vinyl floors (LVT)

Length: 2,70 meters

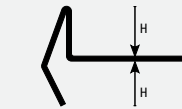

FL - IL

stairtec >> FL-IL in Stainless Steel AISI 304 - DIN 1.4301

	H = mm	Art.		Finish	€ / m	pc ■
	8	FL	80 IL	Polished	15,35	10
	10	FL	100 IL	Polished	16,00	10
	12,5	FL	125 IL	Polished	16,58	10

Profile protected with a removable film.

Length: 2,70 meters

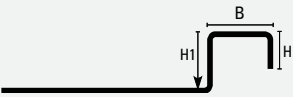

BSJ 20 A* - I*
H1 = 20 mm

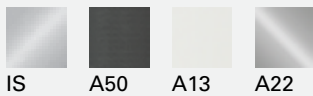

A65

The images are inserted purely for illustrative purposes

bordertec >> BSJ in Brushed Stainless Steel

BxH = mm	Art.		Finish	€ / m	pc ■
20 x 12	BSJ	20 IS	Brushed	39,23	10

For quantities below 10 pcs of profiles with removable protection film 10% price increase applied

bordertec >> BSJ in Power Coated Aluminum

	BxH = mm	Art.		Finish	Variant	€ / m	pc ■
	20 x 12	BSJ	20 A50	Pow. Coated	Embossed Micaceous	21,21	10
new	20 x 12	BSJ	20 A13	Pow. Coated	Antique White	21,21	10
new	20 x 12	BSJ	20 A22	Pow. Coated	Pastel Grey	21,21	10
new	20 x 12	BSJ	20 A65	Pow. Coated	Embossed matt Black	21,21	10

For quantities below 10 pcs 10% price increase applied

bordertec >> BSJE External corner in brushed Stainless Steel

	H = mm	Art.		Finish	Variant	€ / set	set ■
	20	BSJE	20 IS	Brushed	Brushed	49,78	10

bordertec >> BSJE External corner in Power Coated Aluminum

	B = mm	Art.		Finish	Variant	€ / set	set ■
	20	BSJE	20 A50	Pow. Coated	Embossed Micaceous	33,58	10
	20	BSJE	20 A13	Pow. Coated	Antique White	33,58	10
	20	BSJE	20 A65	Pow. Coated	Embossed matt Black	33,58	10

For quantities below 20 pcs 10% price increase applied

Individually wrapped

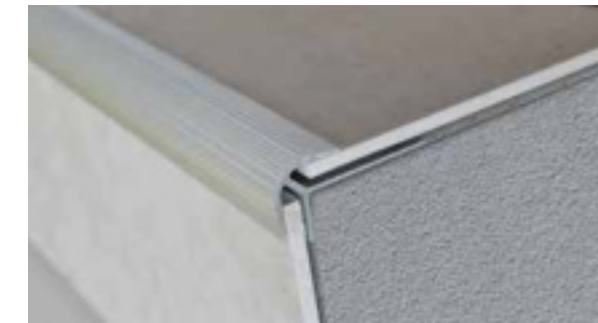

stairtec SVT



stairtec FVT



stairtec FL-IL

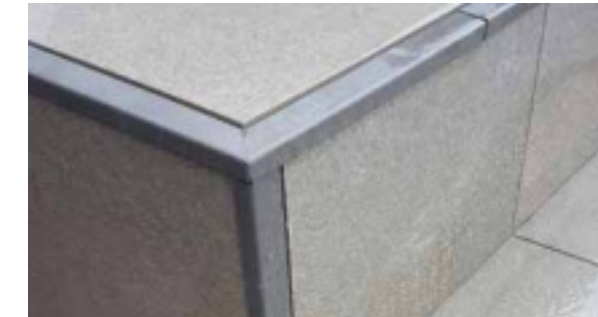

bordertec BSJ 20 A50 + BSJE 20 A50



Length: 2,70 meters

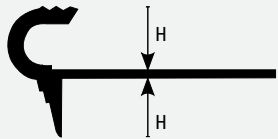

FL - AS
FL - O

Note: Stainless steel version has a slightly different section.

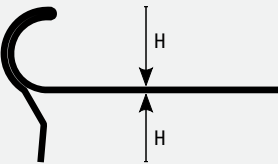

FLR - IL



IL AS ON OL

The images are inserted purely for illustrative purposes

stairtec >> FL-AS in Anodized Aluminum

H = mm	Art.	Finish	Variant	€ / m	pc ■
8	FL 80 AS	Anodized	Silver	8,56	10
10	FL 100 AS	Anodized	Silver	8,88	10
12,5	FL 125 AS	Anodized	Silver	9,43	10

stairtec >> FLT End caps for stair nosing in Stainless Steel AISI 304 - DIN 1.4301

H = mm	Art.	Finish	€ / set	set ■
8	FLT 80 IS	Brushed	37,85	10
10	FLT 100 IS	Brushed	37,85	10
12,5	FLT 125 IS	Brushed	37,85	10

stairtec >> FL-ON in Natural Brass

H = mm	Art.	Finish	€ / m	pc ■
8	FL 80 ON	Natural	25,04	10
10	FL 100 ON	Natural	25,76	10
12,5	FL 125 ON	Natural	27,78	10

stairtec >> FL-OL in Polished Brass

H = mm	Art.	Finish	€ / m	pc ■
8	FL 80 OL	Polished	25,04	10 ☒
10	FL 100 OL	Polished	25,76	10 ☒
12,5	FL 125 OL	Polished	27,78	10 ☒

stairtec >> FLR-IL in Stainless Steel AISI 304 - DIN 1.4301

H = mm	Art.	Finish	€ / m	pc ■
10	FLR 100 IL	Polished	16,55	10
12,5	FLR 125 IL	Polished	16,96	10

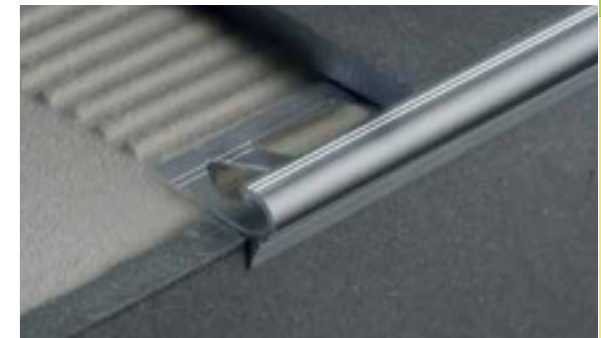

stairtec FL-AS



stairtec FL-OL



stairtec FL



Length: 2,70 meters



RD - O



ON OL

The images are inserted purely for illustrative purposes

roundtec >> RD-ON in Natural Brass

H = mm	Art.	Finish	€ / m	pc ■
8	RD 80 ON	Natural	15,15	10
10	RD 100 ON	Natural	16,31	10
12,5	RD 125 ON	Natural	20,41	10
15	RD 150 ON	Natural	26,66	10

roundtec >> RD-OL in Polished Brass

H = mm	Art.	Finish	€ / m	pc ■
8	RD 80 OL	Polished	19,35	10 ☒
10	RD 100 OL	Polished	20,52	10 ☒
12,5	RD 125 OL	Polished	24,60	10 ☒
15	RD 150 OL	Polished	30,87	10 ☒



☒ For quantities below 20 pcs 10% price increase applied.

non tradotto



Length: 2,70 meters

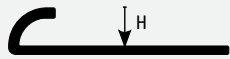

RJ 45 I

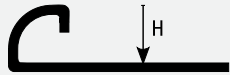

RJ - I



RJC - I



RJI - I

Available end caps with an imitation Polished Stainless Steel finish.



IL/M

The images are inserted purely for illustrative purposes

roundjolly >> RJ in Stainless Steel AISI 304 - DIN 1.4301 - Polished

H = mm	Art.			Finish	€ / m	pc ■
4,5	RJ	45	IL	Polished	10,31	20
6	RJ	60	IL	Polished	10,42	10
8	RJ	80	IL	Polished	11,20	10
10	RJ	100	IL	Polished	12,13	10
12,5	RJ	125	IL	Polished	12,91	10
15	RJ	150	IL	Polished	15,16	10

Profile protected with a removable film.

roundcapsule >> RJC External End Cap in Stainless Steel AISI 304 - DIN 1.4301 - Polished

H = mm	Art.			Finish	€ / set	set ■
4,5	RJC	45	IL	Polished	30,53	2 pcs
6	RJC	60	IL	Polished	30,53	2 pcs
8	RJC	80	IL	Polished	30,53	2 pcs
10	RJC	100	IL	Polished	30,53	2 pcs
12,5	RJC	125	IL	Polished	30,53	2 pcs

roundcapsule >> RJI Internal End Cap in Stainless Steel AISI 304 - DIN 1.4301 - Polished

H = mm	Art.			Finish	€ / set	set ■
6	RJI	60	IL	Polished	30,53	2 pcs
8	RJI	80	IL	Polished	30,53	2 pcs
10	RJI	100	IL	Polished	30,53	2 pcs
12,5	RJI	125	IL	Polished	30,53	2 pcs

roundjolly >> RJ in Stainless Steel AISI 316 - DIN 1.4404 - Polished

H = mm	Art.			Finish	€ / m	pc ■
4,5	RJ	45	ILM	Polished	13,47	10
6	RJ	60	ILM	Polished	13,60	10
8	RJ	80	ILM	Polished	14,38	10
10	RJ	100	ILM	Polished	15,32	10
12,5	RJ	125	ILM	Polished	16,11	10

Thickness 8/10 protected with a removable film.

roundcapsule >> RJC External End Cap in Stainless Steel AISI 316 - DIN 1.4404 - Polished

H = mm	Art.			Finish	€ / set	set ■
6	RJC	60	ILM	Polished	37,85	2 pcs
8	RJC	80	ILM	Polished	37,85	2 pcs
10	RJC	100	ILM	Polished	37,85	2 pcs
12,5	RJC	125	ILM	Polished	37,85	2 pcs

roundcapsule >> RJI Internal End Cap in Stainless Steel AISI 316 - DIN 1.4404 - Polished

H = mm	Art.			Finish	€ / set	set ■
6	RJI	60	ILM	Polished	37,85	2 pcs
8	RJI	80	ILM	Polished	37,85	2 pcs
10	RJI	100	ILM	Polished	37,85	2 pcs
12,5	RJI	125	ILM	Polished	37,85	2 pcs



roundjolly RJ-IL



roundjolly RJ-ILM

✘ For quantities below 20 pcs 10% price increase applied.

Length: 2,70 meters



RJ 45 I

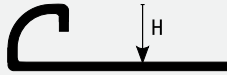

RJ - I



RJC - I



RJI - I

Available end caps with an imitation Polished Stainless Steel finish.



IS IX AS

The images are inserted purely for illustrative purposes

roundjolly >> RJ in Stainless Steel AISI 304 - DIN 1.4301 - Brushed

H = mm	Art.	Finish	€ / m	pc ■
4,5	RJ 45 IS	Brushed	12,89	20
6	RJ 60 IS	Brushed	13,00	10
8	RJ 80 IS	Brushed	13,79	10
10	RJ 100 IS	Brushed	14,72	10
12,5	RJ 125 IS	Brushed	15,52	10
15	RJ 150 IS	Brushed	17,80	10

Profile comes with removable protection film, except RJ45

roundcapsule >> RJC External End Cap in Stainless Steel AISI 304 - DIN 1.4301 - Brushed

H = mm	Art.	Finish	€ / set	set ■
4,5	RJC 45 IS	Brushed	36,62	2 pcs
6	RJC 60 IS	Brushed	36,62	2 pcs
8	RJC 80 IS	Brushed	36,62	2 pcs
10	RJC 100 IS	Brushed	36,62	2 pcs
12,5	RJC 125 IS	Brushed	36,62	2 pcs

roundcapsule >> RJI Internal End Cap in Stainless Steel AISI 304 - DIN 1.4301 - Brushed

H = mm	Art.	Finish	€ / set	set ■
6	RJI 60 IS	Brushed	36,62	2 pcs
8	RJI 80 IS	Brushed	36,62	2 pcs
10	RJI 100 IS	Brushed	36,62	2 pcs
12,5	RJI 125 IS	Brushed	36,62	2 pcs

roundjolly >> RJ in Stainless Steel AISI 304 - DIN 1.4301 - Sanded

H = mm	Art.	Finish	€ / m	pc ■
8	RJ 80 IX	Sanded	14,70	10
10	RJ 100 IX	Sanded	15,65	10
12,5	RJ 125 IX	Sanded	16,46	10

Profile protected with a removable film.

roundcapsule >> RJC External End Cap in Stainless Steel AISI 304 - DIN 1.4301 - Sanded

H = mm	Art.	Finish	€ / set	set ■
8	RJC 80 IX	Sanded	30,53	2 pcs
10	RJC 100 IX	Sanded	30,53	2 pcs
12,5	RJC 125 IX	Sanded	30,53	2 pcs

roundcapsule >> RJI Internal End Cap in Stainless Steel AISI 304 - DIN 1.4301 - Sanded

H = mm	Art.	Finish	€ / set	set ■
8	RJI 80 IX	Sanded	30,53	2 pcs
10	RJI 100 IX	Sanded	30,53	2 pcs
12,5	RJI 125 IX	Sanded	30,53	2 pcs



roundjolly RJ-IS



roundjolly RJ-IX



Length: 2,70 meters

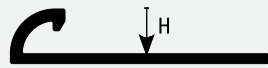

RJ 45 AS

roundjolly >> RJ in Anodized Aluminum

H = mm	Art.	Finish	Variant	€ / m	pc ■
4,5	RJ 45 AS	Anodized	Silver	4,29	40

roundcapsule >> RJC Outside Capsule in Silver Anodized Aluminum

H = mm	Art.	Finish	Variant	€ / set	set ■
4,5	RJC 45 AS	Anodized	Silver	10,99	2 pcs

Length: 2,70 meters

CURVELINE/BENDABLE
Cod SJ-ILD + €/m 3,41

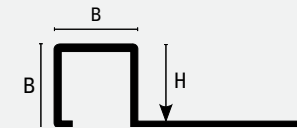

SJ - I

Visible side B:
H size + 1mm
e.g. SJ80 = 9x9mm



SJC - I

squarejolly >> SJ in Stainless Steel AISI 304 - DIN 1.4301 - Polished

H = mm	Art.	Finish	€ / m	pc ■
6	SJ 60 IL	Polished	10,64	10
8	SJ 80 IL	Polished	11,20	10
9	SJ 90 IL	Polished	11,60	10
10	SJ 100 IL	Polished	12,13	10
11	SJ 110 IL	Polished	12,39	10
12,5	SJ 125 IL	Polished	12,91	10
15	SJ 150 IL	Polished	15,16	10

Protected with a removable film.

squarecapsule >> SJC External End Cap in Stainless Steel AISI 304 - DIN 1.4301 - Polished

H = mm	Art.	Finish	€ / set	set ■
6	SJC 60 IL	Polished	30,53	2 pcs
8	SJC 80 IL	Polished	30,53	2 pcs
9	SJC 90 IL	Polished	30,53	2 pcs
10	SJC 100 IL	Polished	30,53	2 pcs
11	SJC 110 IL	Polished	30,53	2 pcs
12,5	SJC 125 IL	Polished	30,53	2 pcs
15	SJC 150 IL	Polished	30,53	2 pcs

Universal end caps (internal and external corner, and three-way intersection).

squarejolly >> SJ in Stainless Steel AISI 316 - DIN 1.4404 - Polished

H = mm	Art.	Finish	€ / m	pc ■
8	SJ 80 ILM	Polished	14,80	10
9	SJ 90 ILM	Polished	15,20	10
10	SJ 100 ILM	Polished	15,73	10
11	SJ 110 ILM	Polished	16,01	10
12,5	SJ 125 ILM	Polished	16,53	10
15	SJ 150 ILM	Polished	18,80	10

Protected with a removable film.

squarecapsule >> SJC External End Cap in Stainless Steel AISI 316 - DIN 1.4404 - Polished

H = mm	Art.	Finish	€ / set	set ■
8	SJC 80 ILM	Polished	38,43	2 pcs
9	SJC 90 ILM	Polished	38,43	2 pcs
10	SJC 100 ILM	Polished	38,43	2 pcs
11	SJC 110 ILM	Polished	38,43	2 pcs
12,5	SJC 125 ILM	Polished	38,43	2 pcs
15	SJC 150 ILM	Polished	38,43	2 pcs

Universal end caps (internal and external corner, and three-way intersection).



squarejolly SJ-IL



squarejolly SJ-ILM

For quantities below 20 pcs 10% price increase applied.

Individually wrapped



Length: 2,70 meters

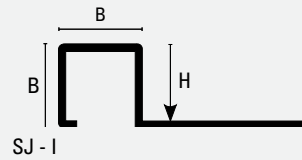

Visible side B:
H size + 1mm
e.g. SJ80 = 9x9mm



SJC - I

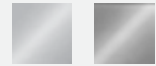

IS IX

The images are inserted purely for illustrative purposes

squarejolly >> SJ-IS in Stainless Steel AISI 304 - DIN 1.4301 - Brushed

H = mm	Art.	Finish	€ / m	pc ■
6	SJ 60 IS	Brushed	13,21	10
8	SJ 80 IS	Brushed	13,79	10
9	SJ 90 IS	Brushed	14,18	10
10	SJ 100 IS	Brushed	14,72	10
11	SJ 110 IS	Brushed	14,99	10
12,5	SJ 125 IS	Brushed	15,52	10
15	SJ 150 IS	Brushed	17,80	10

Protected with a removable film.

squarecapsule >> SJC External End Cap in Stainless Steel AISI 304 - DIN 1.4301 - Brushed

H = mm	Art.	Finish	€ / set	set ■
6	SJC 60 IS	Brushed	36,89	2 pcs
8	SJC 80 IS	Brushed	36,89	2 pcs
9	SJC 90 IS	Brushed	36,89	2 pcs
10	SJC 100 IS	Brushed	36,89	2 pcs
11	SJC 110 IS	Brushed	36,89	2 pcs
12,5	SJC 125 IS	Brushed	36,89	2 pcs
15	SJC 150 IS	Brushed	36,89	2 pcs

Universal end caps (internal and external corner, and three-way intersection).

squarejolly >> SJ-IX in Stainless Steel AISI 304 - DIN 1.4301 - Sanded

H = mm	Art.	Finish	€ / m	pc ■
8	SJ 80 IX	Sanded	14,70	10
10	SJ 100 IX	Sanded	15,65	10
12,5	SJ 125 IX	Sanded	16,46	10

Protected with a removable film.

squarecapsule >> SJC External End Cap in Stainless Steel AISI 304 - DIN 1.4301 - Sanded

H = mm	Art.	Finish	€ / set	set ■
8	SJC 80 IX	Sanded	30,98	2 pcs
10	SJC 100 IX	Sanded	30,98	2 pcs
12,5	SJC 125 IX	Sanded	30,98	2 pcs

Universal end caps (internal and external corner, and three-way intersection).

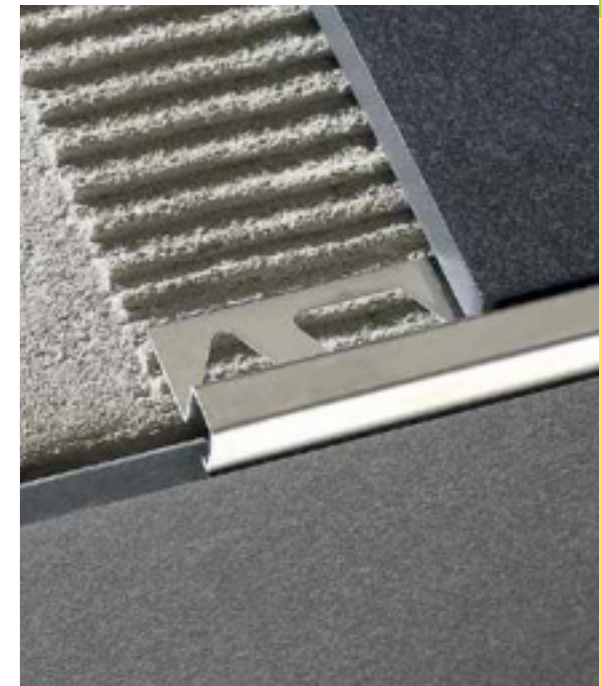

squarejolly SJ-IS



tiled steps

stair nosing

squarejolly SJ-IS

☒ For quantities below 20 pcs 10% price increase applied.

📦 Individually wrapped



Length: 1,35 m

Visible side B:
H size + 1mm
e.g. SJ80 = 9x9mm

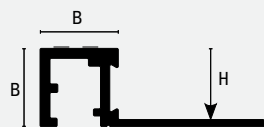

SJR 100 AS



SJR is certified R11. Anti-slip properties, in accordance with DIN 51130 (06/2004).

to be used only for interiors.

squarejolly >> SJR in Anodized Aluminum - with Resin Grip

H = mm	Art.	Finish	Variant	€ / pc	pc ■
10	SJR 100 AS	Anodized	Silver	55,96	10

squarecapsule >> SJC External End Cap in Anodized Aluminum

H = mm	Art.	Finish	Variant	€ / set	set ■
10	SJC 100 AS	Anodized	Silver	10,99	2 pcs

Universal end caps (internal and external corner, and three-way intersection). Loose pcs not available.



squarejolly SJR-AS

Length: 2,70 meters



SJM 44 AS
B = 5,1 mm

squarejolly >> SJM in Anodized Aluminum for mosaic and thin tiles

H = mm	Art.	Finish	Variant	€ / m	pc ■
4,4	SJM 44 AS	Anodized	Silver	5,58	40

squarecapsule >> SJC External End Cap in Anodized Aluminum

H = mm	Art.	Finish	Variant	€ / set	set ■
4,4	SJC 44 AS	Anodized	Silver	11,03	2 pcs

Universal end caps (internal and external corner, and three-way intersection). Loose pcs not available.



stairtec SJM 44 AS

Length: 2,50 m



FO - IL
B = 30 mm

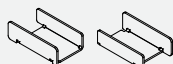

FOTI - IS

Length: 2,70 meters



FO - 0

stairtec >> FO-IL in Stainless Steel AISI 304 - DIN 1.4301 - Polished

H = mm	Art.	Finish	€ / m	pc ■
10	FO 100 IL	Polished	15,02	8
12,5	FO 125 IL	Polished	15,53	8

stairtec >> FOTI End caps for FO in Stainless Steel AISI 304 - DIN 1.4301 Brushed

H = mm	Art.	Finish	€ / set	set ■
10	FOTI 100 IS	Brushed	37,85	10

Universal end cap (Right/Left).

stairtec >> FO-ON in Natural Brass

H = mm	Art.	Finish	€ / m	pc ■
10	FO 100 ON	Natural	24,33	8
12,5	FO 125 ON	Natural	25,63	8

stairtec >> FO-OL in Polished Brass

H = mm	Art.	Finish	€ / m	pc ■
10	FO 100 OL	Polished	28,52	10
12,5	FO 125 OL	Polished	29,84	10



stairtec FO-IL



stairtec FO 100 ON

☒ For quantities below 20 pcs 10% price increase applied.

☒ Individually wrapped



Length: 2,70 meters

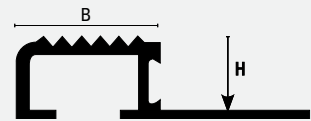

FO - AS
B = 20 mm

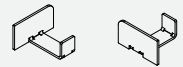

FOTA - IS

stairtec >> FO-AS in Anodized Aluminum

H = mm	Art.	Finish	Variant	€/ m	pc ■
4,5	FO 45 AS	Anodized	Silver	8,99	10
8	FO 80 AS	Anodized	Silver	9,36	10
10	FO 100 AS	Anodized	Silver	9,74	10
12,5	FO 125 AS	Anodized	Silver	10,36	10

stairtec >> FOTA End caps in Stainless Steel AISI 304 - DIN 1.4301 Brushed

H = mm	Art.	Finish	€/ set	set ■
4,5	FOTA 45 IS	Brushed	37,85	10
8	FOTA 80 IS	Brushed	37,85	10
10	FOTA 100 IS	Brushed	37,85	10
12,5	FOTA 125 IS	Brushed	37,85	10

Universal caps (L/R). End caps for FO in Aluminum



stairtec FO 45 AS

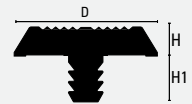

SWP 25 IL
H = 5 mm
H1 = 8 mm

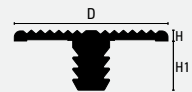

SWR 25 IL
H = 1,6 mm
H1 = 9,75 mm

SWR is certified R11. Anti-slip properties. According to standard DIN 51130 (06/2004).

stairtec >> SWP in Stainless Steel AISI 303 - DIN 1.4305 - Polished

H = mm	Art.	Finish	€/ pc	pc ■
25	SWP 25 IL	Polished	6,04	10

Non-disposable product.

Wheelbase: 70 mm

Wood 6,5 mm
Stone 7 mm



stairtec >> SWR in Stainless Steel AISI 303 - DIN 1.4305 - Polished

H = mm	Art.	Finish	€/ pc	pc ■
25	SWR 25 IL	Polished	5,64	10

Non-disposable product.

Wheelbase: 70 mm

Wood 6,5 mm
Stone 7 mm

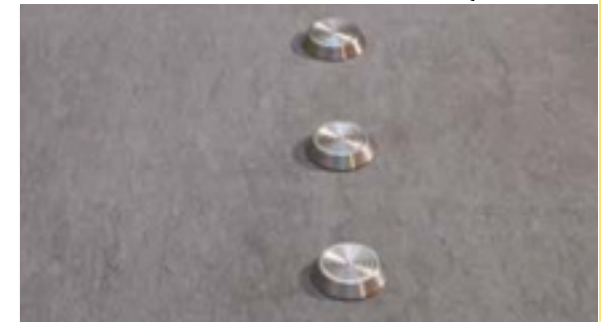

stairtec SWP 25 IL



stairtec SWR 25 IL

Length: 2,70 meters

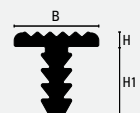

SW 10 AS
H = 1,6 mm
H1 = 8 mm

stairtec >> SW 10 AS in Anodized Aluminum

B = mm	Art.	Finish	Variant	€/ m	pc ■
10	SW 10 AS	Anodized	Silver	6,70	5

Wood 3,5 mm
Stone 4 mm

☒ For quantities below 20 pcs 10% price increase applied.



stairtec SW 10 AS



Length: 2,50 m

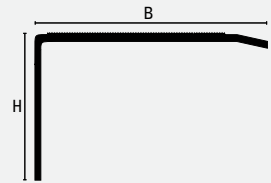

SI 400 IL



IL

stairtec >> SI in Stainless Steel AISI 304 - DIN 1.4301 - Polished

BxH = mm	Art.	Finish	€/ m	pc ■
40x25	SI 400 IL	Polished	20,72	5

Profile protected with a removable film.

walktec >> SWH Carborundum self-adhesive "Strip Walk"

H = mmxm	Art.	Finish	Variant	€/ roll	roll ■
25x18,3	SWH 25 C10	Carborundum	Transparent in roll	38,44	1
25x18,3	SWH 25 C11	Carborundum	White gummed in roll	45,18	1
25x18,3	SWH 25 C51	Carborundum	Black in roll	38,44	1

Anti-slip insert has to be ordered separately.



stairtec SI 400 IL + SWH 25 C51

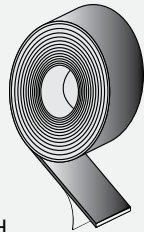

SWH



SWH product is certified R13. Anti-slip properties. According to standard DIN 51130 (06/2004).

walktec >> SWH Carborundum self-adhesive "Strip Walk"

H = mmxm	Art.	Finish	Variant	€/ roll	roll ■
25x18,3	SWH 25 C10	Carborundum	Transparent in roll	38,44	1
25x18,3	SWH 25 C11	Carborundum	White gummed in roll	45,18	1
25x18,3	SWH 25 C51	Carborundum	Black in roll	38,44	1
19x18,3	SWH 19 C51	Carborundum	Black in roll	33,02	1
50x18,3	SWH 50 C51	Carborundum	Black in roll	76,16	1
19x0.61	SWHS 19 C51	Carborundum	Black in strips	1,92	50
19x18,3	SWH 19 CF	Carborundum	Photoluminescent* in roll	105,84	1

*It recharges with natural or artificial light and releases brightness in the dark.



stairtec AE-OLN

Length: 2,70 meters

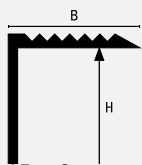

AE 21 O



AS AO AB OL

The images are inserted purely for illustrative purposes

stairtec >> AE in Anodized Aluminum

HxB mm	Art.	Finish	Variant	€/ m	pc ■
21 x 21	AE 21 ASN	Anodized	Silver	5,77	10
21 x 21	AE 21 AON	Anodized	Gold	5,77	10
21 x 21	AE 21 ABN	Anodized	Bronze	5,77	10

stairtec >> AE in Brass

HxB mm	Art.	Finish	€/ m	pc ■
21 x 21	AE 21 OLN	Polished	20,28	10
30 x 30	AE 30 OLN	Polished	26,92	10

☒ For quantities below 20 pcs 10% price increase applied.

☒ Individually wrapped

Length: 2,70 meters

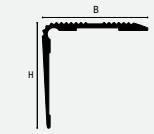

SE 40 ASN

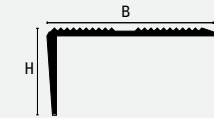

SE 42 A

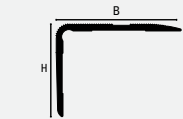

SE 45 A

stairtec >> SE in Anodized Aluminum

BxH = mm	Art.	Finish	Variant	€ / m	pc ■
40 x 40	SE 40 ASN	Anodized	Silver	10,83	10
42 x 22	SE 42 ASN	Anodized	Silver	8,53	10
45 x 33	SE 45 ASN	Anodized	Silver	10,41	10
42 x 22	SE 42 AON	Anodized	Gold	8,53	10
45 x 33	SE 45 AON	Anodized	Gold	10,41	10
42 x 22	SE 42 ABN	Anodized	Bronze	8,53	10
45 x 33	SE 45 ABN	Anodized	Bronze	10,41	10

stairtec >> SE in Anodized Aluminum - Self-Adhesive

BxH = mm	Art.	Finish	Variant	€ / m	pc ■
45 x 33	SE 45 ASA	Anodized	Silver Self-Adhesive	12,31	10
45 x 33	SE 45 AOA	Anodized	Gold Self-Adhesive	12,31	10
45 x 33	SE 45 ABA	Anodized	Bronze Self-Adhesive	12,31	10

Length: 2,70 meters

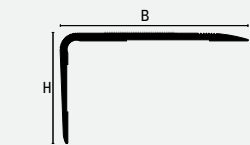

SA 52 A

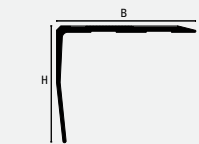

SA 65 ASN

stairtec >> SA in Anodized Aluminum

BxH = mm	Art.	Finish	Variant	€ / m	pc ■
52 x 30	SA 52 ASN	Anodized	Silver	13,58	10
65 x 55	SA 65 ASN	Anodized	Silver	15,61	10
52 x 30	SA 52 AON	Anodized	Gold	13,58	10
52 x 30	SA 52 ABN	Anodized	Bronze	13,58	10

For the SA 65 ASN profile, the anti-slip strip SWH 50 C51 is available separately. Anti-slip insert has to be ordered separately.

stairtec >> SA in Anodized Aluminum - Self-Adhesive

BxH = mm	Art.	Finish	Variant	€ / m	pc ■
52 x 30	SA 52 ASA	Anodized	Silver Self-Adhesive	15,48	10
52 x 30	SA 52 AOA	Anodized	Gold Self-Adhesive	15,48	10
52 x 30	SA 52 ABA	Anodized	Bronze Self-Adhesive	15,48	10

walktec >> SWH Carborundum self-adhesive "Strip Walk"

H mmxm	Art.	Finish	Variant	€ / roll	roll ■
19x18.3	SWH 19 C51	Carborundum	Black in roll	33,02	1
50x18.3	SWH 50 C51	Carborundum	Black in roll	76,16	1
19x18.3	SWH 19 CF	Carborundum	Photoluminescent* in roll	105,84	1

The anti-slip strip SWH 50 C51 is only available for the SA 65 ASN profile. Anti-slip insert has to be ordered separately.

SWH product is certified R13. Anti-slip properties. According to standard DIN 51130 (06/2004).

For quantities below 20 pcs 10% price increase applied.

non tradotto



stair+tec SE-ASN

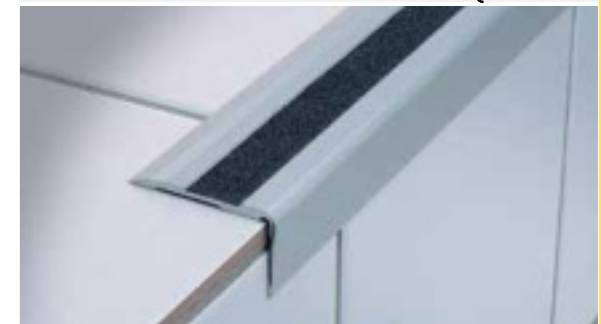

stair+tec SA 52 ASN + SWH 19 C51

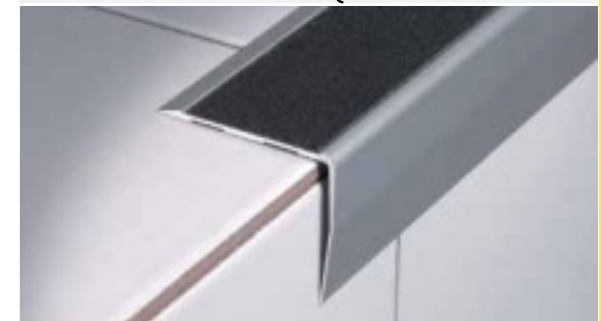

stair+tec SA 65 ASN + SWH 50 C51

ribbed on existing floors

stair nosing



Length: 2,70 meters

- SELFLINE-A/KIT PRE-CUT
0,90 and 1,35 m + €/m 1,23
- SELFLINE-F/KIT PRE-CUT
0,90 and 1,35 m + €/m 1,52

5 + 5 x 0,90 m
7 + 7 x 1,35 m

screws + dowels
(Not included in the packaging)

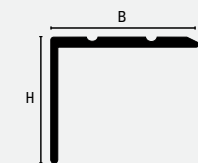
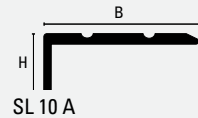

SL 20 A

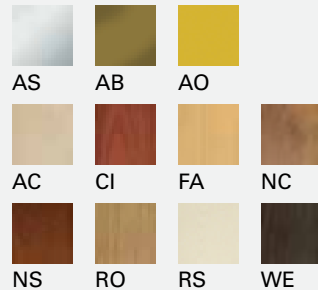

The images are inserted purely for illustrative purposes

stairtec >> SL in Anodized Aluminum - Self-Adhesive

	BxH = mm	Art.	Finish	Variant	€/ m	pc ■
⊗	25 x 10	SL 10 ASA	Anodized	Silver Self-Adhesive	5,61	30
⊗	25 x 20	SL 20 ASA	Anodized	Silver Self-Adhesive	6,52	20
⊗	25 x 10	SL 10 ABA	Anodized	Bronze Self-Adhesive	5,61	30
⊗	25 x 20	SL 20 ABA	Anodized	Bronze Self-Adhesive	6,52	20
⊗	25 x 10	SL 10 AOA	Anodized	Gold Self-Adhesive	5,61	30
⊗	25 x 20	SL 20 AOA	Anodized	Gold Self-Adhesive	6,52	20

stairtec >> SL in Anodized Aluminum - Drilled

	BxH = mm	Art.	Finish	Variant	€/ m	pc ■
⊗	25 x 10	SL 10 ASF	Anodized	Silver Drilled	4,14	30
⊗	25 x 20	SL 20 ASF	Anodized	Silver Drilled	5,05	20
⊗	25 x 10	SL 10 ABF	Anodized	Bronze Drilled	4,14	30
⊗	25 x 20	SL 20 ABF	Anodized	Bronze Drilled	5,05	20
⊗	25 x 10	SL 10 AOF	Anodized	Gold Drilled	4,14	30
⊗	25 x 20	SL 20 AOF	Anodized	Gold Drilled	5,05	20

stairtec >> SL in Aluminum with wood effect - Self-Adhesive

	BxH = mm	Art.	Finish	Variant	€/ m	pc ■
	25 x 20	SL 20 ACA	Wood effect	Maple - Self-Adhesive	12,24	20
	25 x 20	SL 20 CIA	Wood effect	Cherry - Self-Adhesive	12,24	20
	25 x 20	SL 20 FAA	Wood effect	Beechwood - Self-Adhesive	12,24	20
	25 x 20	SL 20 NCA	Wood effect	Light Walnut - Self-Adhesive	12,24	20
	25 x 20	SL 20 NSA	Wood effect	Dark Walnut - Self-Adhesive	12,24	20
	25 x 20	SL 20 RSA	Wood effect	Bleached Oak Adhesive	12,24	20
	25 x 20	SL 20 ROA	Wood effect	Oak - Self-Adhesive	12,24	20
	25 x 20	SL 20 WEA	Wood effect	Wengè - Self-Adhesive	12,24	20

stairtec >> SL in Wood effect Aluminum - Drilled

	BxH = mm	Art.	Finish	Variant	€/ m	pc ■
	25 x 20	SL 20 ACF	Wood effect	Maple Drilled	10,76	20
	25 x 20	SL 20 CIF	Wood effect	Cherry Drilled	10,72	20
	25 x 20	SL 20 FAF	Wood effect	Beechwood Drilled	10,76	20
	25 x 20	SL 20 NCF	Wood effect	Light Walnut Drilled	10,76	20
	25 x 20	SL 20 NSF	Wood effect	Dark Walnut Drilled	10,76	20
	25 x 20	SL 20 ROF	Wood effect	Oak Drilled	10,76	20
	25 x 20	SL 20 RSF	Wood effect	Bleached Drilled	10,76	20
	25 x 20	SL 20 WEF	Wood effect	Wengè Drilled	10,76	20



stairtec SL 20 AOA



stairtec SL 20 ROA



stairtec SL 20 WEA

⊗ For quantities below 20 pcs 10% price increase applied.

■ Individually wrapped

⊗ Profile available in a pre-cut version



Length: 2,70 meters

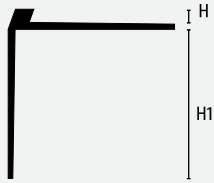

SC 30 A



AS AO AB

The images are inserted purely for illustrative purposes

stairtec >> SC in Anodized Aluminum

	H+H1 mm	Art.			Finish	Variant	€ / m	pc ■
	2,5 + 30	SC	30	ASN	Anodized	Silver	7,37	10
	2,5 + 30	SC	30	AON	Anodized	Gold	7,37	10
	2,5 + 30	SC	30	ABN	Anodized	Bronze	7,37	10



stairtec SC 30 ASN

Length: 2,70 meters

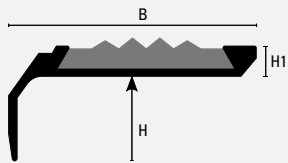

SM
H1 = 5 mm



SML 28 P



SMI 28 P

SML and SMI insert available in 20 m rolls



AS AO AB OL

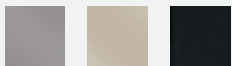

P23 P32 P51

The images are inserted purely for illustrative purposes

stairtec >> SM-A*N in Anodized Aluminum

	BxH mm	Art.			Finish	Variant	€ / m	pc ■
	42 x 14	SM	14	ASN	Anodized	Silver	8,35	10
	42 x 28	SM	28	ASN	Anodized	Silver	10,42	10
	42 x 14	SM	14	AON	Anodized	Gold	8,35	10
	42 x 28	SM	28	AON	Anodized	Gold	10,42	10
	42 x 14	SM	14	ABN	Anodized	Bronze	8,35	10
	42 x 28	SM	28	ABN	Anodized	Bronze	10,42	10

Non-slip insert not included to be ordered separately. Select art. SMI 28 or SML 28.

stairtec >> SM in Natural Brass

	BxH = mm	Art.			Finish	€ / m	pc ■
	42 x 14	SM	14	OLN	Polished	28,81	10

Non-slip insert not included to be ordered separately. Select art. SMI 28 or SML 28.

stairtec >> SM Non-slip insert - Smooth

	B = mm	Art.			Finish	Variant	€ / m	roll ■
	28	SML	28	P23	Smooth	Cement Grey	2,76	1
	28	SML	28	P32	Smooth	Dark Beige	2,76	1
	28	SML	28	P51	Smooth	Black Graphite	2,76	1

Available in rolls to be applied upon installation to art.SM14 and SM28. Must be ordered separately.

stairtec >> SM Knurled non-slip insert

	B = mm	Art.			Finish	Variant	€ / m	roll ■
	28	SMI	28	P23	Knurled	Cement Grey	2,76	1
	28	SMI	28	P32	Knurled	Dark Beige	2,76	1
	28	SMI	28	P51	Knurled	Black Graphite	2,76	1

Available in rolls to be applied upon installation to art.SM14 and SM28. Must be ordered separately.



stairtec SM 14 AON + SMI 28 P23



stairtec SM 28 ASN + SMI 28 P23

☒ For quantities below 20 pcs 10% price increase applied.



The Multiclip system is ideal to compensate steps thicknesses of 6 to 15 mm (± 1.5 mm).

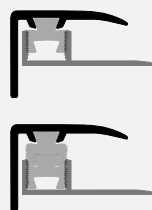

Length: 2,70 meters



CL 80 P

1 piece for 6 to 10mm
2 pieces 11 to 15mm

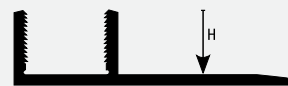

CLB 80 AN

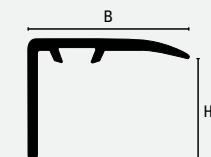

CLS 250

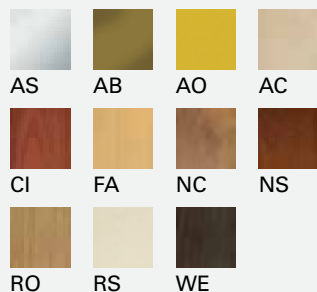

The images are inserted purely for illustrative purposes

CLS250

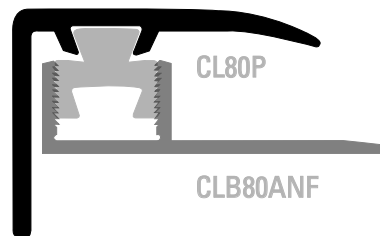

The CLS250 Multiclip system is composed of a pre-drilled base, a clip and a profile, that creates a versatile and modern stair nosing. The base consists of a clip system, stackable together (up to max. 2) to adapt to different heights and needs.

multiclip >> CL in Synthetic Resin

H = mm	Art.	Finish	€ / m	pc ■
8	CL 80 P	Synthetic Resin	1,35	120

multiclip >> CLB Drilled fixing base in Natural Aluminum

H = mm	Art.	Finish	Variant	€ / m	pc ■
8	CLB 80 ANF	Natural	Drilled	5,55	10

multiclip >> CLB 80 Perforated fixing base in Natural Aluminum

H = mm	Art.	Finish	Variant	€ / m	pc ■
8	CLB 80 ANT	Natural	Perforated	5,47	10

multiclip >> CLS250 in Anodized Aluminum

B = mm	Art.	Finish	Variant	€ / m	pc ■
25	CLS 250 AS	Anodized	Silver	7,63	20
25	CLS 250 AB	Anodized	Bronze	7,63	20
25	CLS 250 AO	Anodized	Gold	7,63	20

Clip and base to be order separately in the standard version 2,70 m

multiclip >> CLS250 in Wood Laminated Aluminum

B = mm	Art.	Finish	Variant	€ / m	pc ■
25	CLS 250 AC	Wood effect	Maple	14,46	20
25	CLS 250 CI	Wood effect	Cherry	14,46	20
25	CLS 250 FA	Wood effect	Beechwood	14,46	20
25	CLS 250 NC	Wood effect	Light Walnut	14,46	20
25	CLS 250 NS	Wood effect	Dark Walnut	14,46	20
25	CLS 250 RO	Wood effect	Oak	14,46	20
25	CLS 250 RS	Wood effect	Bleached	14,46	20
25	CLS 250 WE	Wood effect	Wengè	14,46	20

Clip and base to be order separately in the standard version 2,70 m

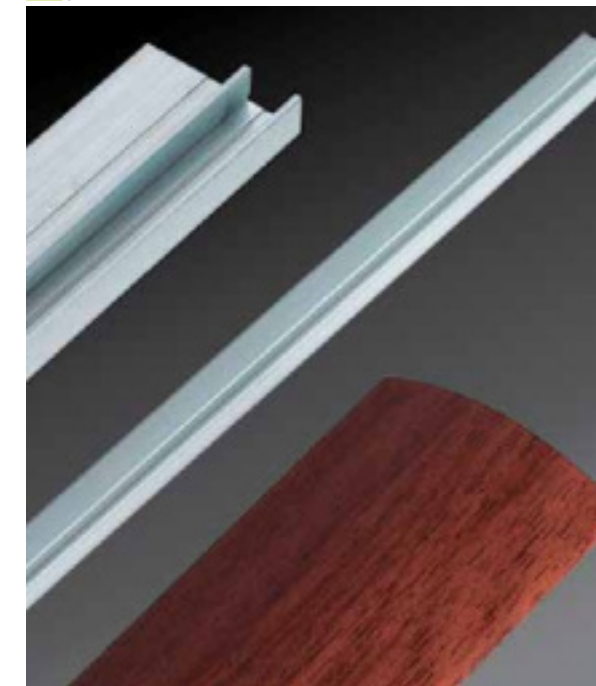

multiclip



multiclip CLS 250 AC

✘ For quantities below 20 pcs 10% price increase applied.

☑ Individually wrapped

Length: 2,00 m

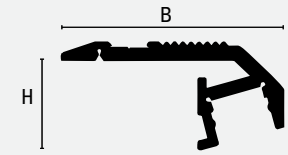

LES 54 AS



AS

The images are inserted purely for illustrative purposes



LEC 15 OP



LEST 54 AS

LED Profiles >> LES in Anodized Aluminum						
HxB mm	Art.		Finish	Variant	€ / m	pc ■
21 x 54	LES	54 AS	Anodized	Silver	57,70	1

LED Profiles >> Light diffuser						
H = mm	Art.		Finish	€ / m	pc ■	
15	LEC	15 OP	Opal	28,86	1	
15	LEC	15 TR	Transparent	25,64	1	
15	LEC	15 SA	Sanded	25,64	1	

LED Profiles >> Accessories						
H = mm	Art.		Finish	€ / set	set ■	
54	LEST	54 AS	End caps (right and left)	39,37	2 pcs	
H = mm	Art.		Finish	€ / m	roll ■	
10	LESA	10	Black adhesive strip 30m	7,63	1	

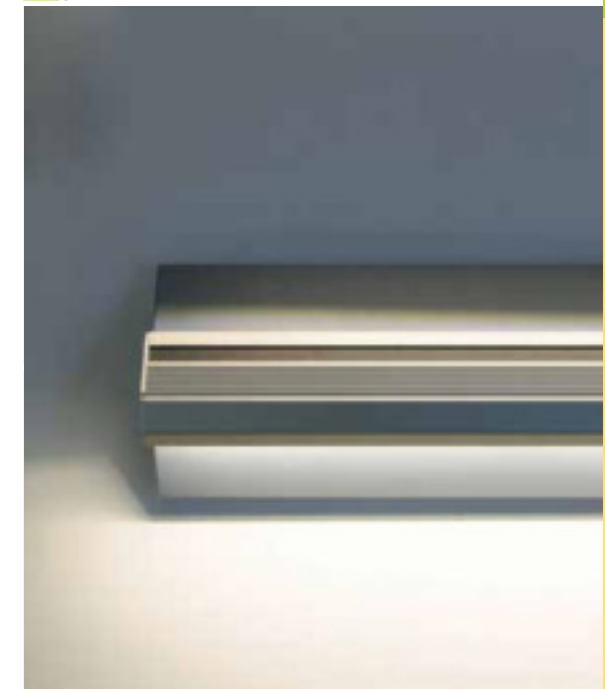
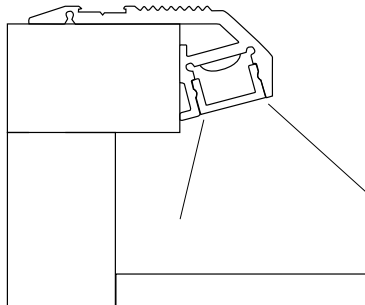

stair nosing LES 54 AS + LESA10

non tradotto

stair nosing

For quantities below 20 pcs 10% price increase applied.

Individually wrapped



Length: 3,00 meters

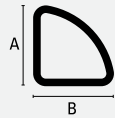

TTR 16



glue screed



AO OL

The images are inserted purely for illustrative purposes

rod >> TTR in Anodized Aluminum

AxB mm	Art.	Finish	Variant	€ / m	pc ■
16 x 16	TTR 16 AO	Bright Polished Anodized	Gold	29,68	10

rod >> TTR in Brass Polished

AxB mm	Art.	Finish	€ / m	pc ■
16 x 16	TTR 16 OL	Polished	29,86	10

Fixing support >> STR in Brass for triangular Stair Rod (right+left)

Art.	Finish	€ / set	set ■
STR 13 OL	Polished	26,57	10



Triangular Stair Rod TTR 16 OL

End caps to be ordered separately according to the diameter: art. TAP-OL + Ø.art. TOP-OL + Ø.



TTO

Diameters:

TTO11: Ø = 11 mm

TTO13: Ø = 13 mm

TTO15: Ø = 15 mm



AO

The images are inserted purely for illustrative purposes

rod >> TTO in Anodized Aluminum

L = cm	Art.	Finish	Variant	€ / pc	pc ■
80	TTO 11 AO	Anodized	Gold	6,97	20
90	TTO 11 AO	Anodized	Gold	7,62	20
100	TTO 11 AO	Anodized	Gold	8,36	20
120	TTO 11 AO	Anodized	Gold	9,68	20
320	TTO 11 AO	Anodized	Gold	21,30	20
80	TTO 13 AO	Anodized	Gold	7,55	20
90	TTO 13 AO	Anodized	Gold	8,45	20
100	TTO 13 AO	Anodized	Gold	9,03	20
120	TTO 13 AO	Anodized	Gold	10,83	20
320	TTO 13 AO	Anodized	Gold	22,37	20
80	TTO 15 AO	Anodized	Gold	9,19	20
90	TTO 15 AO	Anodized	Gold	9,90	20
100	TTO 15 AO	Anodized	Gold	10,67	20
120	TTO 15 AO	Anodized	Gold	12,21	20
320	TTO 15 AO	Anodized	Gold	24,96	20



Triangular Stair Rod TTR 16 AO

Individually wrapped



Pre-cut to length

Supplied with endcaps, art. TAP-OL



TTO

Diameters:

TTO11: Ø = 11 mm

TTO13: Ø = 13 mm

TTO15: Ø = 15 mm



ASB OL

The images are inserted purely for illustrative purposes

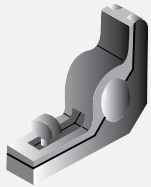

CER



SUP

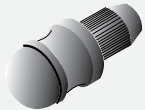

TAP

rod >> TTO in Bright Polished Aluminum

L = cm	Art.	Finish	Variant	€ / m	pc ■
320	TTO 11 ASB	Bright Polished Anodized	Chrome	7,19	20

rod >> TTO in Brass Polished

L = cm	Art.	Finish	€ / pc	pc ■
80	TTO 11 OL	Polished	12,46	10
90	TTO 11 OL	Polished	13,68	10
100	TTO 11 OL	Polished	14,89	10
120	TTO 11 OL	Polished	17,54	10
320	TTO 11 OL	Polished	42,27	10
80	TTO 13 OL	Polished	15,09	10
90	TTO 13 OL	Polished	16,61	10
100	TTO 13 OL	Polished	18,12	10
120	TTO 13 OL	Polished	21,23	10
320	TTO 13 OL	Polished	50,73	10
80	TTO 15 OL	Polished	17,46	10
90	TTO 15 OL	Polished	19,33	10
100	TTO 15 OL	Polished	21,23	10
120	TTO 15 OL	Polished	24,53	10
320	TTO 15 OL	Polished	58,89	10

support >> Brass eyelet for round tube

Ø = mm	Art.	Finish	€ / pc	pc ■
12	SUP 12 OL	Polished	1,90	100
14	SUP 14 OL	Polished	2,07	100
16	SUP 16 OL	Polished	2,51	100
12	SUP 12 OC	Chrome	3,42	100

support >> Brass hinge for round tube

Ø = mm	Art.	Finish	€ / pc	pc ■
12	CER 12 OL	Polished	9,15	50
14	CER 14 OL	Polished	9,83	50
16	CER 16 OL	Polished	13,49	50

support >> in Brass for round tube closure

Ø = mm	Art.	Finish	€ / pc	pc ■
11	TAP 11 OL	Polished	0,74	100
13	TAP 13 OL	Polished	0,99	100
15	TAP 15 OL	Polished	1,48	100
11	TAP 11 OC	Chrome	1,92	100



Stair Rod TTO 11 ASB



Stair Rod TTO 11 OL





Wall covering

Practical and decorative, economical and durable: PROFILITEC Wall Covering Profiles are a first-rate solution for detailing mosaic, natural stone and all wall tile installations.

Linear profiles act as a vertical reference for tile laying, eliminating the need to cut outside corner tiles at a 45° angle or use special tiled elements. Tile profiles are also an invaluable safeguarding measure to prevent the chipping and cracking of fragile single-fired ceramic tiles.

Linear profiles act as a vertical reference for tile laying, eliminating the need to cut outside corner tiles at a 45° angle or use special tiled elements. Tile profiles are also an invaluable safeguarding measure to prevent the chipping and cracking of fragile single-fired ceramic tiles. PROFILITEC proposes infinite solutions for resolving internal and external wall corners, making them less dangerous and easier to clean.

Available in synthetic, non-toxic materials, brass, aluminum and stainless steel profiles in over 30 trim finishes allow the designer to coordinate or contrast grout and tile colors. The end result is a completely integrated design environment.

Article	Code	Use	Pag.
Squarejolly	SJ	multipurpose	66
Roundjolly	RJ	junction	73
Roundjolly	RJS	junction	81
Filojolly	RJF	invisible junction, mosaic	81
Roundjolly	RJE	junction	81
Trimtec	TR	finish	83
Kerajolly	KJ	finish	84
Mosaictec	SJM	multipurpose mosaic	88
Mosaictec	RJM	junction, mosaic protection	88
Mosaictec	CRM	mosaic	89
Baseboard	BT	mosaic	89
Planotec	BP	mosaic	90
Mosaictec	LIM	mosaic	90
Listec	LI	listello	91
Listec	LIA	compensating shims	93
Appendo	APP	decorative vertical	93
Squarejolly	SJQ	multipurpose	94
Trialjolly	TJ	junction	94
Roundcorner	RO	round corner edge	95
Keracorner	CO	corner edge	96
Wallprotection	WA	corner protection	96
Wallprotection	WP	corner protection	96
Sanitec	RS	cove raccord, corner	97
Roundcorner	RE	junction, corner	98
Sanitec	RT	junction, corner	99
Sanitec	SB	multipurpose junction	100
Coflex	CR	resin cove	103
Sanitec	ER	resin cove	103
Sanitec	IC	existing floors	104
Interjolly	IJ	junction	104
LED profiles	LE*	LED profiles	105





Length: 2,70 meters

CURVELINE/BENDABLE
Cod SJ-ILD + €/m 3,41

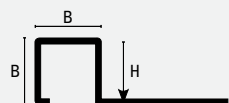

SJ - I

Visible side B:

H size + 1mm

e.g. SJ80 = 9x9mm



SJC-I



IL/M

The images are inserted purely for illustrative purposes

squarejolly >> SJ in Stainless Steel AISI 304 - DIN 1.4301 - Polished

H = mm	Art.			Finish	€/ m	pc ■
<input checked="" type="checkbox"/>	6	SJ	60 IL	Polished	10,64	10
<input checked="" type="checkbox"/>	8	SJ	80 IL	Polished	11,20	10
<input checked="" type="checkbox"/>	9	SJ	90 IL	Polished	11,60	10
<input checked="" type="checkbox"/>	10	SJ	100 IL	Polished	12,13	10
<input checked="" type="checkbox"/>	11	SJ	110 IL	Polished	12,39	10
<input checked="" type="checkbox"/>	12,5	SJ	125 IL	Polished	12,91	10
<input checked="" type="checkbox"/>	15	SJ	150 IL	Polished	15,16	10

B= H + 1 mm. Profile protected with a removable film.

squarecapsule >> SJC End caps in Stainless Steel AISI 304 - DIN 1.4301 - Polished

H = mm	Art.			Finish	€/ set	set ■
	6	SJC	60 IL	Polished	30,53	2 pcs
	8	SJC	80 IL	Polished	30,53	2 pcs
	9	SJC	90 IL	Polished	30,53	2 pcs
	10	SJC	100 IL	Polished	30,53	2 pcs
	11	SJC	110 IL	Polished	30,53	2 pcs
	12,5	SJC	125 IL	Polished	30,53	2 pcs
	15	SJC	150 IL	Polished	30,53	2 pcs

Universal end caps (internal and external corner, and three-way intersection).

squarejolly >> SJ in Stainless Steel AISI 316 - DIN 1.4404 - Polished

H = mm	Art.			Finish	€/ m	pc ■
	8	SJ	80 ILM	Polished	14,80	10
	9	SJ	90 ILM	Polished	15,20	10
	10	SJ	100 ILM	Polished	15,73	10
	11	SJ	110 ILM	Polished	16,01	10
	12,5	SJ	125 ILM	Polished	16,53	10
	15	SJ	150 ILM	Polished	18,80	10

B= H + 1 mm. Profile protected with a removable film.

squarecapsule >> SJC End caps in Stainless Steel AISI 316 - DIN 1.4404 - Polished

H = mm	Art.			Finish	€/ set	set ■
	8	SJC	80 ILM	Polished	38,43	2 pcs
	9	SJC	90 ILM	Polished	38,43	2 pcs
	10	SJC	100 ILM	Polished	38,43	2 pcs
	11	SJC	110 ILM	Polished	38,43	2 pcs
	12,5	SJC	125 ILM	Polished	38,43	2 pcs
	15	SJC	150 ILM	Polished	38,43	2 pcs

Universal end caps (internal and external corner, and three-way intersection).



squarejolly SJ-IL



squarejolly SJ-ILM

For quantities below 20 pcs 10% price increase applied.

Bendable with bending machine

Length: 2,70 meters

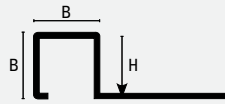

SJ - I

Visible side B:
H size + 1mm
e.g. SJ80 = 9x9mm



SJC-I



IS IX

The images are inserted purely for illustrative purposes

squarejolly >> SJ in Stainless Steel AISI 304 - DIN 1.4301 - Brushed

H = mm	Art.		Finish	€ / m	pc ■
6	SJ	60 IS	Brushed	13,21	10
8	SJ	80 IS	Brushed	13,79	10
9	SJ	90 IS	Brushed	14,18	10
10	SJ	100 IS	Brushed	14,72	10
11	SJ	110 IS	Brushed	14,99	10
12,5	SJ	125 IS	Brushed	15,52	10
15	SJ	150 IS	Brushed	17,80	10

Profile protected with a removable film.

squarecapsule >> SJC End caps in Stainless Steel AISI 304 - DIN 1.4301 - Brushed

H = mm	Art.		Finish	€ / set	set ■
6	SJC	60 IS	Brushed	36,89	2 pcs
8	SJC	80 IS	Brushed	36,89	2 pcs
9	SJC	90 IS	Brushed	36,89	2 pcs
10	SJC	100 IS	Brushed	36,89	2 pcs
11	SJC	110 IS	Brushed	36,89	2 pcs
12,5	SJC	125 IS	Brushed	36,89	2 pcs
15	SJC	150 IS	Brushed	36,89	2 pcs

Universal end caps (internal and external corner, and three-way intersection).

squarejolly >> SJ in Stainless Steel AISI 304 - DIN 1.4301 - Sanded

H = mm	Art.		Finish	€ / m	pc ■
8	SJ	80 IX	Sanded	14,70	10
10	SJ	100 IX	Sanded	15,65	10
12,5	SJ	125 IX	Sanded	16,46	10

squarecapsule >> SJC End caps in Stainless Steel AISI 304 - DIN 1.4301 - Sanded

H = mm	Art.		Finish	€ / set	set ■
8	SJC	80 IX	Sanded	30,98	2 pcs
10	SJC	100 IX	Sanded	30,98	2 pcs
12,5	SJC	125 IX	Sanded	30,98	2 pcs

Universal end caps (internal and external corner, and three-way intersection).



Solid form

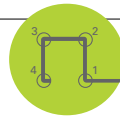

- + Double floor support
- + Grout lock for the Aluminum version
- + Four folds to increase the solidity



squarejolly SJ-IS



squarejolly SJ-IX

multipurpose

wall covering

☒ For quantities below 20pcs price increase by 10%

Length: 2,70 meters

CURVELINE/BENDABLE
Cod SJ-ASD + €/m 1,73

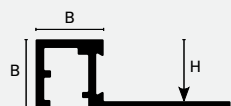

SJ - A

Visible side B:
H size + 1mm
e.g. SJ80 = 9x9mm



SJC-A*

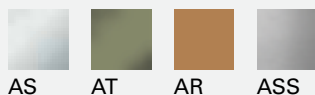

AMSB

The images are inserted purely for illustrative purposes

squarejolly >> SJ in Anodized Aluminum

H = mm	Art.		Finish	Variant	€/ m	pc ■
6	SJ	60 AS	Anodized	Silver	4,90	40
<input checked="" type="checkbox"/> 8	SJ	80 AS	Anodized	Silver	5,27	40
<input checked="" type="checkbox"/> 9	SJ	90 AS	Anodized	Silver	5,61	40
<input checked="" type="checkbox"/> 10	SJ	100 AS	Anodized	Silver	5,75	40
<input checked="" type="checkbox"/> 11	SJ	110 AS	Anodized	Silver	6,06	40
<input checked="" type="checkbox"/> 12,5	SJ	125 AS	Anodized	Silver	6,49	30
8	SJ	80 AT	Anodized	Titan	6,94	40
9	SJ	90 AT	Anodized	Titan	7,18	40
10	SJ	100 AT	Anodized	Titan	7,44	40
11	SJ	110 AT	Anodized	Titan	7,82	40
12,5	SJ	125 AT	Anodized	Titan	8,30	30
8	SJ	80 AR	Anodized	Copper	6,94	40
9	SJ	90 AR	Anodized	Copper	7,18	40
10	SJ	100 AR	Anodized	Copper	7,44	40
11	SJ	110 AR	Anodized	Copper	7,82	40
12,5	SJ	125 AR	Anodized	Copper	8,30	30

squarecapsule >> SJC in Anodized Aluminum

H = mm	Art.		Finish	Variant	€/ set	set ■
6	SJC	60 A*	Anodized	AS	10,99	2 pcs
8	SJC	80 A*	Anodized	AS/AR/AT	10,99	2 pcs
9	SJC	90 A*	Anodized	AS/AR/AT	10,99	2 pcs
10	SJC	100 A*	Anodized	AS/AR/AT	10,99	2 pcs
11	SJC	110 A*	Anodized	AS/AR/AT	10,99	2 pcs
12,5	SJC	125 A*	Anodized	AS/AR/AT	10,99	2 pcs

Universal end caps (internal and external corner, and three-way intersection).

squarejolly >> SJ-A* in Brushed Anodized Aluminum

H = mm	Art.		Finish	Variant	€/ m	pc ■
8	SJ	80 ASS	Brushed Anodized	Silver	8,29	40
9	SJ	90 ASS	Brushed Anodized	Silver	8,58	40
10	SJ	100 ASS	Brushed Anodized	Silver	8,87	40
11	SJ	110 ASS	Brushed Anodized	Silver	9,32	40
12,5	SJ	125 ASS	Brushed Anodized	Silver	9,83	30
8	SJ	80 AMSB	Brushed Anodized	Antique Bronze	16,60	40
10	SJ	100 AMSB	Brushed Anodized	Antique Bronze	16,88	40
12,5	SJ	125 AMSB	Brushed Anodized	Antique Bronze	17,04	30

squarecapsule >> SJC in Brushed Anodized Aluminum

H = mm	Art.		Finish	Variant	€/ set	set ■
8	SJC	80 ASS	Brushed Anodized	ASS	12,83	2 pcs
9	SJC	90 ASS	Brushed Anodized	ASS	12,83	2 pcs
10	SJC	100 ASS	Brushed Anodized	ASS	12,83	2 pcs
11	SJC	110 ASS	Brushed Anodized	ASS	12,83	2 pcs
12,5	SJC	125 ASS	Brushed Anodized	ASS	12,83	2 pcs
10	SJC	100 AMSB	Brushed Anodized	AMSB	17,63	2 pcs
12,5	SJC	125 AMSB	Brushed Anodized	AMSB	17,63	2 pcs

Universal end caps (internal and external corner, and three-way intersection).

For quantities below 20 pcs 10% price increase applied.

Individually wrapped

Bendable with bending machine



squarejolly SJ-AS



squarejolly SJ-AT

Length: 2,70 meters

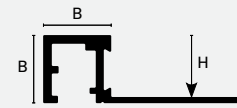

SJ - A

Visible side B:
H size + 1mm
e.g. SJ80 = 9x9mm



SJC-A*

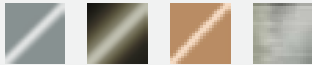

ASB ATB ARB ASSB

The images are inserted purely for illustrative purposes

squarejolly >> SJ in Bright Polished Anodized Aluminum

H = mm	Art.	Finish	Variant	€ / m	pc ■
6	SJ 60 ASB	Bright Polished Anodized	Chrome	8,55	40
8	SJ 80 ASB	Bright Polished Anodized	Chrome	9,01	40
9	SJ 90 ASB	Bright Polished Anodized	Chrome	9,70	40
10	SJ 100 ASB	Bright Polished Anodized	Chrome	10,07	40
11	SJ 110 ASB	Bright Polished Anodized	Chrome	10,65	40
12,5	SJ 125 ASB	Bright Polished Anodized	Chrome	11,30	30
8	SJ 80 ATB	Bright Polished Anodized	Titan	9,32	40
9	SJ 90 ATB	Bright Polished Anodized	Titan	10,03	40
10	SJ 100 ATB	Bright Polished Anodized	Titan	10,41	40
11	SJ 110 ATB	Bright Polished Anodized	Titan	11,01	40
12,5	SJ 125 ATB	Bright Polished Anodized	Titan	11,69	30
8	SJ 80 ARB	Bright Polished Anodized	Copper	9,32	40
9	SJ 90 ARB	Bright Polished Anodized	Copper	10,03	40
10	SJ 100 ARB	Bright Polished Anodized	Copper	10,41	40
11	SJ 110 ARB	Bright Polished Anodized	Copper	11,01	40
12,5	SJ 125 ARB	Bright Polished Anodized	Copper	11,69	30

squarecapsule >> SJC in Bright Polished Anodized Aluminum

H = mm	Art.	Finish	Variant	€ / set	set ■
6	SJC 60 A*B	Bright Polished Anodized	ASB	10,99	2 pcs
8	SJC 80 A*B	Bright Polished Anodized	ASB/ARB/ATB	10,99	2 pcs
9	SJC 90 A*B	Bright Polished Anodized	ASB/ARB/ATB	10,99	2 pcs
10	SJC 100 A*B	Bright Polished Anodized	ASB/ARB/ATB	10,99	2 pcs
11	SJC 110 A*B	Bright Polished Anodized	ASB/ARB/ATB	10,99	2 pcs
12,5	SJC 125 A*B	Bright Polished Anodized	ASB/ARB/ATB	10,99	2 pcs

Universal end caps (internal and external corner, and three-way intersection).

squarejolly >> SJ-ASSB in Bright Polished Brushed Anodized Aluminum

H = mm	Art.	Finish	Variant	€ / m	pc ■
8	SJ 80 ASSB	Bright Polished Brushed Anodized	Silver	10,25	40
9	SJ 90 ASSB	Bright Polished Brushed Anodized	Silver	10,70	40
10	SJ 100 ASSB	Bright Polished Brushed Anodized	Silver	11,14	40
11	SJ 110 ASSB	Bright Polished Brushed Anodized	Silver	12,54	40
12,5	SJ 125 ASSB	Bright Polished Brushed Anodized	Silver	13,93	30

squarecapsule >> SJC in Bright Polished Brushed Anodized Aluminum

H = mm	Art.	Finish	Variant	€ / set	set ■
8	SJC 80 ASSB	Bright Polished Brushed Anodized	ASSB	14,09	2 pcs
9	SJC 90 ASSB	Bright Polished Brushed Anodized	ASSB	14,09	2 pcs
10	SJC 100 ASSB	Bright Polished Brushed Anodized	ASSB	14,09	2 pcs
11	SJC 110 ASSB	Bright Polished Brushed Anodized	ASSB	14,09	2 pcs
12,5	SJC 125 ASSB	Bright Polished Brushed Anodized	ASSB	14,09	2 pcs

Universal end caps (internal and external corner, and three-way intersection).



squarejolly SJ-ASB + SJC-ASB



squarejolly SJ-ARB + SJC-ARB

✘ For quantities below 20pcs price increase by 10%
 ■ Individually wrapped



Length: 2,70 meters

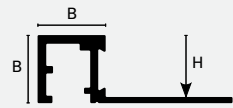

SJ - A

Visible side B:
H size + 1mm
e.g. SJ80 = 9x9mm



SJC-A

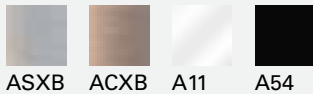

ASXB ACXB A11 A54



AM11

The images are inserted purely for illustrative purposes

multipurpose

wall covering

squarejolly >> SJ in Bright Polished Sanded Anodized Aluminum

H = mm	Art.	Finish	Variant	€ / m	pc ■
8	SJ 80 ASXB	Bright Polished Sanded Anodized	Silver	11,01	40
9	SJ 90 ASXB	Bright Polished Sanded Anodized	Silver	11,51	40
10	SJ 100 ASXB	Bright Polished Sanded Anodized	Silver	11,98	40
11	SJ 110 ASXB	Bright Polished Sanded Anodized	Silver	13,47	40
12,5	SJ 125 ASXB	Bright Polished Sanded Anodized	Silver	14,96	30
8	SJ 80 ACXB	Bright Polished Sanded Anodized	Champagne	11,01	30
9	SJ 90 ACXB	Bright Polished Sanded Anodized	Champagne	11,51	30
10	SJ 100 ACXB	Bright Polished Sanded Anodized	Champagne	11,98	30
11	SJ 110 ACXB	Bright Polished Sanded Anodized	Champagne	13,47	30
12,5	SJ 125 ACXB	Bright Polished Sanded Anodized	Champagne	14,96	40

squarecapsule >> SJC in Bright Polished Sanded Anodized Aluminum

H = mm	Art.	Finish	Variant	€ / set	set ■
8	SJC 80 A*XB	Bright Polished Sanded Anodized	ASXB/ACXB	14,09	2 pcs
9	SJC 90 A*XB	Bright Polished Sanded Anodized	ASXB/ACXB	14,09	2 pcs
10	SJC 100 A*XB	Bright Polished Sanded Anodized	ASXB/ACXB	14,09	2 pcs
11	SJC 110 A*XB	Bright Polished Sanded Anodized	ASXB/ACXB	14,09	2 pcs
12,5	SJC 125 A*XB	Bright Polished Sanded Anodized	ASXB/ACXB	14,09	2 pcs

Universal end caps (internal and external corner, and three-way intersection). Loose pcs not available.

squarejolly >> SJ in Powder Coated Aluminum

H = mm	Art.	Finish	Variant	€ / m	pc ■	
8	SJ 80 A11	Pow. Coated	Pure White	7,04	40	
9	SJ 90 A11	Pow. Coated	Pure White	7,28	40	
10	SJ 100 A11	Pow. Coated	Pure White	7,67	40	
11	SJ 110 A11	Pow. Coated	Pure White	7,95	40	
12,5	SJ 125 A11	Pow. Coated	Pure White	8,58	30	
new	6	SJ 60 A54	Pow. Coated	Matt Black	6,48	40
new	8	SJ 80 A54	Pow. Coated	Matt Black	7,04	40
new	10	SJ 100 A54	Pow. Coated	Matt Black	7,67	40
new	12,5	SJ 125 A54	Pow. Coated	Matt Black	8,59	30
new	6	SJ 60 AM11	Pow. Coated	Matt White	6,48	40
new	8	SJ 80 AM11	Pow. Coated	Matt White	7,04	40
new	10	SJ 100 AM11	Pow. Coated	Matt White	7,67	40
new	12,5	SJ 125 AM11	Pow. Coated	Matt White	8,59	30

squarecapsule >> SJC in Powder Coated Aluminum

H = mm	Art.	Finish	Variant	€ / set	set ■
6	SJC 60 A*	Pow. Coated	A54/AM11	10,99	2 pcs
8	SJC 80 A*	Pow. Coated	A11/A54/AM11	10,99	2 pcs
9	SJC 90 A*	Pow. Coated	A11	10,99	2 pcs
10	SJC 100 A*	Pow. Coated	A11/A54/AM11	10,99	2 pcs
11	SJC 110 A*	Pow. Coated	A11	10,99	2 pcs
12,5	SJC 125 A*	Pow. Coated	A11/A54/AM11	10,99	2 pcs

Universal end caps (internal and external corner, and three-way intersection). Loose pcs not available.



squarejolly SJ-ASXB + SJC-ASXB



squarejolly SJ-ACXB + SJC-ACXB



squarejolly SJ-A11

✘ For quantities below 20pcs price increase by 10%

☑ Individually wrapped

Length: 2,70 meters

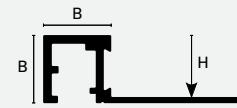

SJ - A

Visible side B:
H size + 1mm
e.g. SJ80 = 9x9mm



SJC-A*

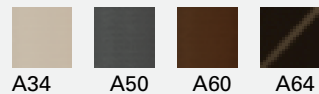

A65

The images are inserted purely for illustrative purposes

squarejolly >> SJ in Powder Coated Aluminum Modern Line

H = mm	Art.	Finish	Variant	€ / m	pc ■
8	SJ 80 A13	Pow. Coated	Embossed Antique White	7,04	40
10	SJ 100 A13	Pow. Coated	Embossed Antique White	7,67	40
11	SJ 110 A13	Pow. Coated	Embossed Antique White	7,95	40
12,5	SJ 125 A13	Pow. Coated	Embossed Antique White	8,58	30
8	SJ 80 A24	Pow. Coated	Embossed Pastel Grey	7,04	40
10	SJ 100 A24	Pow. Coated	Embossed Pastel Grey	7,67	40
11	SJ 110 A24	Pow. Coated	Embossed Pastel Grey	7,95	40
12,5	SJ 125 A24	Pow. Coated	Embossed Pastel Grey	8,58	30
8	SJ 80 A25	Pow. Coated	Embossed Cement Grey	7,04	40
10	SJ 100 A25	Pow. Coated	Embossed Cement Grey	7,67	40
11	SJ 110 A25	Pow. Coated	Embossed Cement Grey	7,95	40
12,5	SJ 125 A25	Pow. Coated	Embossed Cement Grey	8,58	30
8	SJ 80 A33	Pow. Coated	Embossed Dove-Grey	7,04	40
10	SJ 100 A33	Pow. Coated	Embossed Dove-Grey	7,67	40
11	SJ 110 A33	Pow. Coated	Embossed Dove-Grey	7,95	40
12,5	SJ 125 A33	Pow. Coated	Embossed Dove-Grey	8,58	30
8	SJ 80 A34	Pow. Coated	Embossed Kaki	7,04	40
10	SJ 100 A34	Pow. Coated	Embossed Kaki	7,67	40
11	SJ 110 A34	Pow. Coated	Embossed Kaki	7,95	40
12,5	SJ 125 A34	Pow. Coated	Embossed Kaki	8,58	30
8	SJ 80 A50	Pow. Coated	Embossed Micaceous	7,04	40
10	SJ 100 A50	Pow. Coated	Embossed Micaceous	7,67	40
11	SJ 110 A50	Pow. Coated	Embossed Micaceous	7,95	40
12,5	SJ 125 A50	Pow. Coated	Embossed Micaceous	8,58	30
8	SJ 80 A60	Pow. Coated	Embossed Corten	7,04	40
10	SJ 100 A60	Pow. Coated	Embossed Corten	7,67	40
11	SJ 110 A60	Pow. Coated	Embossed Corten	7,95	40
12,5	SJ 125 A60	Pow. Coated	Embossed Corten	8,58	30
8	SJ 80 A64	Pow. Coated	Embossed Dark Brown	7,04	40
10	SJ 100 A64	Pow. Coated	Embossed Dark Brown	7,67	40
11	SJ 110 A64	Pow. Coated	Embossed Dark Brown	7,95	40
12,5	SJ 125 A64	Pow. Coated	Embossed Dark Brown	8,58	30
8	SJ 80 A65	Pow. Coated	Embossed matt Black	7,04	40
10	SJ 100 A65	Pow. Coated	Embossed matt Black	7,67	40
11	SJ 110 A65	Pow. Coated	Embossed matt Black	7,95	40
12,5	SJ 125 A65	Pow. Coated	Embossed matt Black	8,58	30

squarecapsule >> SJC in Embossed Powder Coated Aluminum Wall Modern Line

H = mm	Art.	Finish	Variant	€ / set	set ■
8	SJC 80 A*	Pow. Coated	A13/A24/A25/A33/A34/A50/A60/A64/A65	10,99	2 pcs
10	SJC 100 A*	Pow. Coated	A13/A24/A25/A33/A34/A50/A60/A64/A65	10,99	2 pcs
11	SJC 110 A*	Pow. Coated	A13/A24/A25/A33/A34/A50/A60/A64/A65	10,99	2 pcs
12,5	SJC 125 A*	Pow. Coated	A13/A24/A25/A33/A34/A50/A60/A64/A65	10,99	2 pcs



squarejolly SJ-A13 + SJC-A13



squarejolly SJ-A34 + SJC-A34

multipurpose

wall covering

☒ For quantities below 20pcs price increase by 10%



Length: 2,70 meters

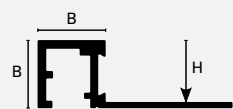

SJ - A

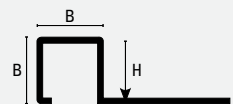

SJ - 0

Visible side B:

H size + 1mm

e.g. SJ80 = 9x9mm



SJC-A



SJC-OL

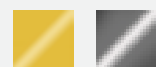
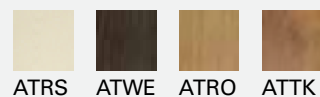

OL OC

The images are inserted purely for illustrative purposes

squarejolly >> SJ in High Resistance Wood Laminated Aluminum

H = mm	Art.			Finish	Variant	€ / m	pc ■
8	SJ	80	ATRS	Wood effect	Texture Bleached	10,08	40
10	SJ	100	ATRS	Wood effect	Texture Bleached	10,58	40
12,5	SJ	125	ATRS	Wood effect	Texture Bleached	11,42	30
8	SJ	80	ATWE	Wood effect	Texture Wengè	10,08	40
10	SJ	100	ATWE	Wood effect	Texture Wengè	10,58	40
12,5	SJ	125	ATWE	Wood effect	Texture Wengè	11,42	30
8	SJ	80	ATTK	Wood effect	Texture Teak	10,08	40
10	SJ	100	ATTK	Wood effect	Texture Teak	10,58	40
12,5	SJ	125	ATTK	Wood effect	Texture Teak	11,42	30
8	SJ	80	ATRO	Wood effect	Texture Oak	10,08	40
10	SJ	100	ATRO	Wood effect	Texture Oak	10,58	40
12,5	SJ	125	ATRO	Wood effect	Texture Oak	11,42	30

squarecapsule >> SJC in High Resistance Wood Laminated Aluminum

H = mm	Art.			Finish	Variant	€ / set	set ■
8	SJC	80	AT*	Wood effect	ATRS/ATRO/ATWE/ATTK	25,61	2 pcs
10	SJC	100	AT*	Wood effect	ATRS/ATRO/ATWE/ATTK	25,61	2 pcs
12,5	SJC	125	AT*	Wood effect	ATRS/ATRO/ATWE/ATTK	25,61	2 pcs

squarejolly >> SJ in Polished Brass

H = mm	Art.			Finish	€ / m	pc ■
8	SJ	80	OL	Polished	14,80	10
10	SJ	100	OL	Polished	15,97	10
12,5	SJ	125	OL	Polished	17,52	10

Profile protected with a removable film.

squarecapsule >> SJC in Polished Brass

H = mm	Art.			Finish	€ / set	set ■
8	SJC	80	OL	Polished	23,24	2 pcs
10	SJC	100	OL	Polished	23,24	2 pcs
12,5	SJC	125	OL	Polished	23,24	2 pcs

Universal end caps (internal and external corner, and three-way intersection). Loose pcs not available.

squarejolly >> SJ in Chromed Brass

H = mm	Art.			Finish	€ / m	pc ■
8	SJ	80	OC	Chrome	23,89	10
10	SJ	100	OC	Chrome	26,10	10
12,5	SJ	125	OC	Chrome	28,40	10

squarecapsule >> SJC in Chromed Brass

H = mm	Art.			Finish	€ / set	set ■
8	SJC	80	OC	Chrome	31,82	2 pcs
10	SJC	100	OC	Chrome	31,82	2 pcs
12,5	SJC	125	OC	Chrome	31,82	2 pcs

Universal end caps (internal and external corner, and three-way intersection). Loose pcs not available.



squarejolly SJ-ATRS



squarejolly SJ-OL

✘ For quantities below 20pcs price increase by 10%

☑ Individually wrapped



Length: 2,70 meters

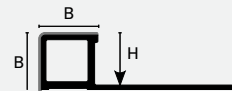

SJ - P

Visible side B:
H size + 1mm
e.g. SJ80 = 9x9mm

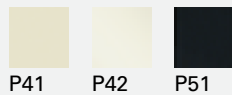
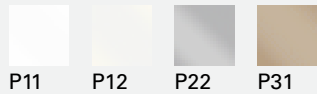

The images are inserted purely for illustrative purposes

squarejolly >> SJ in Synthetic Resin Full Body Colored Resintop

H = mm	Art.			Finish	Variant	€ / m	pc ■
6	SJ	60	P11	Synthetic Resin	Pure White	1,75	120
8	SJ	80	P11	Synthetic Resin	Pure White	1,92	100
10	SJ	100	P11	Synthetic Resin	Pure White	2,15	70
6	SJ	60	P12	Synthetic Resin	White	1,75	120
8	SJ	80	P12	Synthetic Resin	White	1,92	100
10	SJ	100	P12	Synthetic Resin	White	2,15	70
6	SJ	60	P22	Synthetic Resin	Pastel Grey	1,75	120
8	SJ	80	P22	Synthetic Resin	Pastel Grey	1,92	100
10	SJ	100	P22	Synthetic Resin	Pastel Grey	2,15	70
6	SJ	60	P31	Synthetic Resin	Beige Bahama	1,75	120
8	SJ	80	P31	Synthetic Resin	Beige Bahama	1,92	100
10	SJ	100	P31	Synthetic Resin	Beige Bahama	2,15	70
6	SJ	60	P41	Synthetic Resin	Cream	1,75	120
8	SJ	80	P41	Synthetic Resin	Cream	1,92	100
10	SJ	100	P41	Synthetic Resin	Cream	2,15	70
6	SJ	60	P42	Synthetic Resin	Ivory	1,75	120
8	SJ	80	P42	Synthetic Resin	Ivory	1,92	120
10	SJ	100	P42	Synthetic Resin	Ivory	2,15	70
6	SJ	60	P51	Synthetic Resin	Black	1,75	120
8	SJ	80	P51	Synthetic Resin	Black	1,92	100
10	SJ	100	P51	Synthetic Resin	Black	2,15	70



squarejolly SJ-P11

Length: 2,70 meters



RJ - I



RJC-IL



RJI-I

Available end caps with an imitation Polished Stainless Steel finish.



IL

The images are inserted purely for illustrative purposes

roundjolly >> RJ in Stainless Steel AISI 304 - DIN 1.4301 Polished

H = mm	Art.			Finish	€ / m	pc ■
4,5	RJ	45	IL	Polished	10,31	20
6	RJ	60	IL	Polished	10,42	10
8	RJ	80	IL	Polished	11,20	10
10	RJ	100	IL	Polished	12,13	10
12,5	RJ	125	IL	Polished	12,91	10
15	RJ	150	IL	Polished	15,16	10

Profile protected with a removable film.

roundcapsule >> RJC End caps in Stainless Steel AISI 304 - DIN 1.4301 Polished

H = mm	Art.			Finish	€ / set	set ■
4,5	RJC	45	IL	Polished	30,53	2 pcs
6	RJC	60	IL	Polished	30,53	2 pcs
8	RJC	80	IL	Polished	30,53	2 pcs
10	RJC	100	IL	Polished	30,53	2 pcs
12,5	RJC	125	IL	Polished	30,53	2 pcs
15	RJC	150	IL	Polished	30,53	2 pcs

Available end caps in Aluminum with an imitation Polished Stainless Steel Polished Cod. RJC-AI €/set 6,66 (2pz)



roundjolly RJ-IL

junction

wall covering

✘ For quantities below 20pcs price increase by 10%



Length: 2,70 meters



RJ - I



RJC-IL



RJI-I

Available end caps with an imitation Polished Stainless Steel finish.



ILM IS IX

The images are inserted purely for illustrative purposes

roundjolly >> RJ in Stainless Steel AISI 316 -DIN 1.4404 - Polished

H = mm	Art.			Finish	€ / m	pc ■
4,5	RJ	45	ILM	Polished	13,47	10
6	RJ	60	ILM	Polished	13,60	10
8	RJ	80	ILM	Polished	14,38	10
10	RJ	100	ILM	Polished	15,32	10
12,5	RJ	125	ILM	Polished	16,11	10

Thickness 8/10 - protected by plastic film

roundcapsule >> RJC/RJI stainless steel capsule aisi 316 din 14404 bright

H = mm	Art.			Finish	€ / set	set ■
6	RJC/RJI	60	ILM	Polished	37,85	2 pcs
8	RJC/RJI	80	ILM	Polished	37,85	2 pcs
10	RJC/RJI	100	ILM	Polished	37,85	2 pcs
12,5	RJC/RJI	125	ILM	Polished	37,85	2 pcs

roundjolly >> RJ in Stainless Steel AISI 304 - DIN 1.4301 Brushed

H = mm	Art.			Finish	€ / m	pc ■
4,5	RJ	45	IS	Brushed	12,89	20
6	RJ	60	IS	Brushed	13,00	10
8	RJ	80	IS	Brushed	13,79	10
10	RJ	100	IS	Brushed	14,72	10
12,5	RJ	125	IS	Brushed	15,52	10
15	RJ	150	IS	Brushed	17,80	10

Profile protected with a removable film.

roundcapsule >> RJC/RJI stainless steel capsule aisi 304 din 14301 brushed

H = mm	Art.			Finish	€ / set	set ■
4,5	RJC	45	IS	Brushed	36,62	2 pcs
6	RJC/RJI	60	IS	Brushed	36,62	2 pcs
8	RJC/RJI	80	IS	Brushed	36,62	2 pcs
10	RJC/RJI	100	IS	Brushed	36,62	2 pcs
12,5	RJC/RJI	125	IS	Brushed	36,62	2 pcs
15	RJC	150	IS	Brushed	36,62	2 pcs

roundjolly >> RJ in Stainless Steel AISI 304 - DIN 1.4301 Sanded

H = mm	Art.			Finish	€ / m	pc ■
8	RJ	80	IX	Sanded	14,70	10
10	RJ	100	IX	Sanded	15,65	10
12,5	RJ	125	IX	Sanded	16,46	10

roundcapsule >> RJC/RJI stainless steel capsule aisi 304 din 14301 sanded

H = mm	Art.			Finish	€ / set	set ■
8	RJC/RJI	80	IX	Sanded	30,53	2 pcs
10	RJC/RJI	100	IX	Sanded	30,53	2 pcs
12,5	RJC/RJI	125	IX	Sanded	30,53	2 pcs



roundjolly RJ-ILM



roundjolly RJ-IS



roundjolly RJ-IX

☒ For quantities below 20pcs price increase by 10%



Length: 2,70 meters

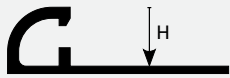

RJ - A



RJC-A



RJI-A

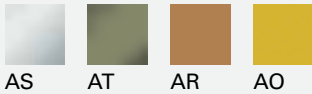

AMSB

The images are inserted purely for illustrative purposes

roundjolly >> RJ in Anodized Aluminum

H = mm	Art.	Finish	Variant	€/ m	pc ■
4,5	RJ 45 AS	Anodized	Silver	4,29	40
6	RJ 60 AS	Anodized	Silver	4,29	40
8	RJ 80 AS	Anodized	Silver	4,42	40
10	RJ 100 AS	Anodized	Silver	4,80	40
11	RJ 110 AS	Anodized	Silver	5,08	40
12,5	RJ 125 AS	Anodized	Silver	5,42	30
6	RJ 60 AT	Anodized	Titan	5,81	40
8	RJ 80 AT	Anodized	Titan	6,11	40
10	RJ 100 AT	Anodized	Titan	6,53	40
12,5	RJ 125 AT	Anodized	Titan	7,26	30
6	RJ 60 AR	Anodized	Copper	5,81	40
8	RJ 80 AR	Anodized	Copper	6,11	40
10	RJ 100 AR	Anodized	Copper	6,53	40
12,5	RJ 125 AR	Anodized	Copper	7,26	30
6	RJ 60 AO	Anodized	Gold	5,81	40
8	RJ 80 AO	Anodized	Gold	6,11	40
10	RJ 100 AO	Anodized	Gold	6,53	40
12,5	RJ 125 AO	Anodized	Gold	7,26	30

roundcapsule >> RJC/RJI End caps in Anodized Aluminum

H = mm	Art.	Finish	Variant	€/ set	set ■
4,5	RJC 45 AS	Anodized	AS	10,99	2 pcs
6	RJC/RJI 60 A*	Anodized	AS/AT/AR/AO	10,99	2 pcs
8	RJC/RJI 80 A*	Anodized	AS/AT/AR/AO	10,99	2 pcs
10	RJC/RJI 100 A*	Anodized	AS/AT/AR/AO	10,99	2 pcs
11	RJC/RJI 110 AS	Anodized	AS	10,99	2 pcs
12,5	RJC/RJI 125 A*	Anodized	AS/AT/AR/AO	10,99	2 pcs

RJC= outside corner; RJI= inside corner

roundjolly >> RJ in Brushed Anodized Aluminum

H = mm	Art.	Finish	Variant	€/ m	pc ■
8	RJ 80 AMSB	Brushed Anodized	Antique Bronze	14,44	40
10	RJ 100 AMSB	Brushed Anodized	Antique Bronze	14,67	40
12,5	RJ 125 AMSB	Brushed Anodized	Antique Bronze	14,84	30

roundcapsule >> RJC/RJI Inside/outside corners in Anodized Brushed Aluminum

H = mm	Art.	Finish	Variant	€/ set	set ■
8	RJC/RJI 80 AMSB	Brushed Anodized	Antique Bronze	11,03	2 pcs
10	RJC/RJI 100 AMSB	Brushed Anodized	Antique Bronze	11,03	2 pcs
12,5	RJC/RJI 125 AMSB	Brushed Anodized	Antique Bronze	11,03	2 pcs

RJC= outside corner; RJI= inside corner



roundjolly RJ-AS



roundjolly RJC-AS

transition

wall covering

☒ For quantities below 20 pcs 10% price increase applied.

☒ Individually wrapped



Length: 2,70 meters



RJ - A



RJC-A



RJI-A

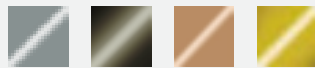

ASB ATB ARB AOB

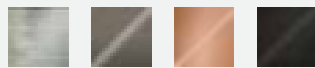

ASSB ATSB ARSB ADSB

The images are inserted purely for illustrative purposes

roundjolly >> RJ in Bright Polished Anodized Aluminum

H = mm	Art.	Finish	Variant	€ / m	pc ■
4,5	RJ 45 ASB	Bright Polished Anodized	Chrome	7,48	40
6	RJ 60 ASB	Bright Polished Anodized	Chrome	7,48	40
8	RJ 80 ASB	Bright Polished Anodized	Chrome	7,98	40
10	RJ 100 ASB	Bright Polished Anodized	Chrome	8,91	40
11	RJ 110 ASB	Bright Polished Anodized	Chrome	9,56	40
12,5	RJ 125 ASB	Bright Polished Anodized	Chrome	10,01	30
6	RJ 60 ATB	Bright Polished Anodized	Titan	7,75	40
8	RJ 80 ATB	Bright Polished Anodized	Titan	8,25	40
10	RJ 100 ATB	Bright Polished Anodized	Titan	9,22	40
12,5	RJ 125 ATB	Bright Polished Anodized	Titan	10,36	30
6	RJ 60 ARB	Bright Polished Anodized	Copper	7,75	40
8	RJ 80 ARB	Bright Polished Anodized	Copper	8,25	40
10	RJ 100 ARB	Bright Polished Anodized	Copper	9,22	40
12,5	RJ 125 ARB	Bright Polished Anodized	Copper	10,36	30
6	RJ 60 AOB	Bright Polished Anodized	Gold	7,75	40
8	RJ 80 AOB	Bright Polished Anodized	Gold	8,25	40
10	RJ 100 AOB	Bright Polished Anodized	Gold	9,22	40
12,5	RJ 125 AOB	Bright Polished Anodized	Gold	10,36	30

roundcapsule >> RJC/RJI End caps in Bright Polished Anodized Aluminum

H = mm	Art.	Finish	Variant	€ / set	set ■
4,5	RJC 45 ASB	Bright Polished Anodized	ASB	10,99	2 pcs
6	RJC/RJI 60 A*B	Bright Polished Anodized	ASB/ATB/ARB/AOB	10,99	2 pcs
8	RJC/RJI 80 A*B	Bright Polished Anodized	ASB/ATB/ARB/AOB	10,99	2 pcs
10	RJC/RJI 100 A*B	Bright Polished Anodized	ASB/ATB/ARB/AOB	10,99	2 pcs
11	RJC/RJI 110 ASB	Bright Polished Anodized	ASB	10,99	2 pcs
12,5	RJC/RJI 125 A*B	Bright Polished Anodized	ASB/ATB/ARB/AOB	10,99	2 pcs

roundjolly >> RJ in Bright Polished Anodized Aluminum - Brushed

H = mm	Art.	Finish	Variant	€ / m	pc ■
8	RJ 80 ASSB	Anod. Bright Poli. Brushed	Silver	11,16	40
10	RJ 100 ASSB	Anod. Bright Poli. Brushed	Silver	12,57	40
12,5	RJ 125 ASSB	Anod. Bright Poli. Brushed	Silver	14,03	30
8	RJ 80 ATSB	Anod. Bright Poli. Brushed	Titan	11,16	40
10	RJ 100 ATSB	Anod. Bright Poli. Brushed	Titan	12,57	40
12,5	RJ 125 ATSB	Anod. Bright Poli. Brushed	Titan	14,03	30
10	RJ 100 ARSB	Anod. Bright Poli. Brushed	Copper	12,57	40
12,5	RJ 125 ARSB	Anod. Bright Poli. Brushed	Copper	14,03	30
10	RJ 100 ADSB	Anod. Bright Poli. Brushed	Black	14,67	40
12,5	RJ 125 ADSB	Anod. Bright Poli. Brushed	Black	14,84	30

roundcapsule >> RJC/RJI Inside/outside corners in Anodized Bright Brushed Aluminum

H = mm	Art.	Finish	Variant	€ / set	set ■
8	RJC/RJI 80 A*SB	Anod. Bright Poli. Brushed	ASSB/ATSB/ARSB	11,03	2 pcs
10	RJC/RJI 100 A*SB	Anod. Bright Poli. Brushed	ASSB/ATSB/ARSB	11,03	2 pcs
12,5	RJC/RJI 125 A*SB	Anod. Bright Poli. Brushed	ASSB/ATSB/ARSB	11,03	2 pcs



Shape and resistance



- + ¼ of perfect circle
- + Solid visible part
- + Internal cavity for adhesive

✗ For quantities below 20 pcs 10% price increase applied.

Individually wrapped



roundjolly RJ-ARB



roundjolly RJ-ATB

Length: 2,70 meters

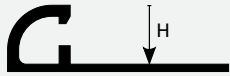

RJ - A



RJC-A



RJI-A



A11 A12 A21 A22

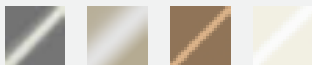

A23 A31 A32 A41

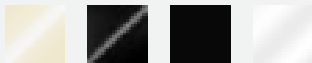

A42 A51 A54 AM11

The images are inserted purely for illustrative purposes

roundjolly >> RJ in Powder Coated Aluminum

	H = mm	Art.	Finish	Variant	€ / m	pc
	4,5	RJ 45 A11	Pow. Coated	Pure White	5,59	40
	6	RJ 60 A11	Pow. Coated	Pure White	5,59	40
	8	RJ 80 A11	Pow. Coated	Pure White	6,24	40
	10	RJ 100 A11	Pow. Coated	Pure White	6,81	40
	12,5	RJ 125 A11	Pow. Coated	Pure White	7,60	30
	4,5	RJ 45 A12	Pow. Coated	White	5,59	40
	6	RJ 60 A12	Pow. Coated	White	5,59	40
	8	RJ 80 A12	Pow. Coated	White	6,24	40
	10	RJ 100 A12	Pow. Coated	White	6,81	40
	12,5	RJ 125 A12	Pow. Coated	White	7,60	30
	4,5	RJ 45 A21	Pow. Coated	Light Grey	5,59	40
	6	RJ 60 A21	Pow. Coated	Light Grey	5,59	40
	8	RJ 80 A21	Pow. Coated	Light Grey	6,24	40
	10	RJ 100 A21	Pow. Coated	Light Grey	6,81	40
	4,5	RJ 45 A22	Pow. Coated	Pastel Grey	5,59	40
	6	RJ 60 A22	Pow. Coated	Pastel Grey	5,59	40
	8	RJ 80 A22	Pow. Coated	Pastel Grey	6,24	40
	10	RJ 100 A22	Pow. Coated	Pastel Grey	6,81	40
	12,5	RJ 125 A22	Pow. Coated	Pastel Grey	7,60	30
	4,5	RJ 45 A23	Pow. Coated	Cement Grey	5,59	40
	6	RJ 60 A23	Pow. Coated	Cement Grey	5,59	40
	8	RJ 80 A23	Pow. Coated	Cement Grey	6,24	40
	10	RJ 100 A23	Pow. Coated	Cement Grey	6,81	40
	4,5	RJ 45 A31	Pow. Coated	Beige Bahama	5,59	40
	6	RJ 60 A31	Pow. Coated	Beige Bahama	5,59	40
	8	RJ 80 A31	Pow. Coated	Beige Bahama	6,24	40
	10	RJ 100 A31	Pow. Coated	Beige Bahama	6,81	40
	12,5	RJ 125 A31	Pow. Coated	Beige Bahama	7,60	30
	4,5	RJ 45 A32	Pow. Coated	Dark Beige	5,59	40
	6	RJ 60 A32	Pow. Coated	Dark Beige	5,59	40
	8	RJ 80 A32	Pow. Coated	Dark Beige	6,24	40
	10	RJ 100 A32	Pow. Coated	Dark Beige	6,81	40
	4,5	RJ 45 A41	Pow. Coated	Cream	5,59	40
	6	RJ 60 A41	Pow. Coated	Cream	5,59	40
	8	RJ 80 A41	Pow. Coated	Cream	6,24	40
	10	RJ 100 A41	Pow. Coated	Cream	6,81	40
	4,5	RJ 45 A42	Pow. Coated	Ivory	5,59	40
	6	RJ 60 A42	Pow. Coated	Ivory	5,59	40
	8	RJ 80 A42	Pow. Coated	Ivory	6,24	40
	10	RJ 100 A42	Pow. Coated	Ivory	6,81	40
	4,5	RJ 45 A51	Pow. Coated	Black	5,59	40
	6	RJ 60 A51	Pow. Coated	Black	5,59	40
	8	RJ 80 A51	Pow. Coated	Black	6,24	40
	10	RJ 100 A51	Pow. Coated	Black	6,81	40
new	6	RJ 60 A54	Pow. Coated	Matt Black	5,59	40
new	8	RJ 80 A54	Pow. Coated	Matt Black	6,24	40
new	10	RJ 100 A54	Pow. Coated	Matt Black	6,81	40
new	12,5	RJ 125 A54	Pow. Coated	Matt Black	7,60	40
new	6	RJ 60 AM11	Pow. Coated	Matt White	5,59	40
new	8	RJ 80 AM11	Pow. Coated	Matt White	6,24	40
new	10	RJ 100 AM11	Pow. Coated	Matt White	6,81	40
new	12,5	RJ 125 AM11	Pow. Coated	Matt White	7,60	40



roundjolly RJ-A11



roundjolly RJ-A51

✘ For quantities below 20pcs price increase by 10%
 ☑ Individually wrapped



Length: 2,70 meters

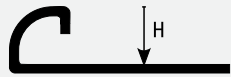

RJ - 0



OC

The images are inserted purely for illustrative purposes

roundcapsule >> RJC/RJI End caps in Powder Coated Aluminum

H = mm	Art.	Finish	Variant	€ / set	set ■
4,5	RJC 45 A*	Pow. Coated	11/12/21/22/23/31/32/41/42/51	7,60	2 pcs
6	RJC/RJI 60 A*	Pow. Coated	11/12/21/22/23/31/32/41/42/51/54/AM11	7,60	2 pcs
8	RJC/RJI 80 A*	Pow. Coated	11/12/21/22/23/31/32/41/42/51/54/AM11	7,60	2 pcs
10	RJC/RJI 100 A*	Pow. Coated	11/12/21/22/23/31/32/41/42/51/54/AM11	7,60	2 pcs
12,5	RJC/RJI 125 A*	Pow. Coated	11/12/22/23/31/54/AM11	7,60	2 pcs

*All colors in painted aluminum available

roundjolly >> RJ in Chromed Brass

H = mm	Art.	Finish	€ / m	pc ■
6	RJ 60 OC	Chrome	21,05	10
8	RJ 80 OC	Chrome	23,38	10
10	RJ 100 OC	Chrome	25,50	10
12,5	RJ 125 OC	Chrome	27,78	10

roundcapsule >> RJC End cap in Chromed Brass

H = mm	Art.	Finish	€ / set	set ■
6	RJC 60 OC	Chrome	31,82	2 pcs
8	RJC 80 OC	Chrome	31,82	2 pcs
10	RJC 100 OC	Chrome	31,82	2 pcs
12,5	RJC 125 OC	Chrome	31,82	2 pcs



roundjolly RJ-OC



roundjolly RJC 100 A11

☒ For quantities below 20pcs price increase by 10%



RJ - A



RJC-A



RJI-A

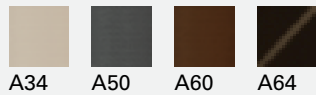

A65

The images are inserted purely for illustrative purposes

roundjolly >> RJ in Powder Coated Aluminum Modern Line

H = mm	Art.	Finish	Variant	€ / m	pc ■
6	RJ 60 A13	Pow. Coated	Embossed Antique White	5,48	40
8	RJ 80 A13	Pow. Coated	Embossed Antique White	6,24	40
10	RJ 100 A13	Pow. Coated	Embossed Antique White	6,81	40
11	RJ 110 A13	Pow. Coated	Embossed Antique White	7,19	40
12,5	RJ 125 A13	Pow. Coated	Embossed Antique White	7,60	30
8	RJ 80 A24	Pow. Coated	Embossed Pastel Grey	6,24	40
10	RJ 100 A24	Pow. Coated	Embossed Pastel Grey	6,81	40
11	RJ 110 A24	Pow. Coated	Embossed Pastel Grey	7,19	40
12,5	RJ 125 A24	Pow. Coated	Embossed Pastel Grey	7,60	30
8	RJ 80 A25	Pow. Coated	Embossed Cement Grey	6,24	40
10	RJ 100 A25	Pow. Coated	Embossed Cement Grey	6,81	40
11	RJ 110 A25	Pow. Coated	Embossed Cement Grey	7,19	40
12,5	RJ 125 A25	Pow. Coated	Embossed Cement Grey	7,60	30
8	RJ 80 A33	Pow. Coated	Embossed Dove-Grey	6,24	40
10	RJ 100 A33	Pow. Coated	Embossed Dove-Grey	6,81	40
11	RJ 110 A33	Pow. Coated	Embossed Dove-Grey	7,19	40
12,5	RJ 125 A33	Pow. Coated	Embossed Dove-Grey	7,60	30
8	RJ 80 A34	Pow. Coated	Embossed Kaki	6,24	40
10	RJ 100 A34	Pow. Coated	Embossed Kaki	6,81	40
11	RJ 110 A34	Pow. Coated	Embossed Kaki	7,19	40
12,5	RJ 125 A34	Pow. Coated	Embossed Kaki	7,60	30
8	RJ 80 A50	Pow. Coated	Embossed Micaceous	6,24	40
10	RJ 100 A50	Pow. Coated	Embossed Micaceous	6,81	40
11	RJ 110 A50	Pow. Coated	Embossed Micaceous	7,19	40
12,5	RJ 125 A50	Pow. Coated	Embossed Micaceous	7,60	30
8	RJ 80 A60	Pow. Coated	Embossed Corten	6,24	40
10	RJ 100 A60	Pow. Coated	Embossed Corten	6,81	40
11	RJ 110 A60	Pow. Coated	Embossed Corten	7,19	40
12,5	RJ 125 A60	Pow. Coated	Embossed Corten	7,60	30
8	RJ 80 A64	Pow. Coated	Embossed Dark Brown	6,24	40
10	RJ 100 A64	Pow. Coated	Embossed Dark Brown	6,81	40
11	RJ 110 A64	Pow. Coated	Embossed Dark Brown	7,19	40
12,5	RJ 125 A64	Pow. Coated	Embossed Dark Brown	7,60	30
8	RJ 80 A65	Pow. Coated	Embossed matt Black	6,24	40
10	RJ 100 A65	Pow. Coated	Embossed matt Black	6,81	40
11	RJ 110 A65	Pow. Coated	Embossed matt Black	7,19	40
12,5	RJ 125 A65	Pow. Coated	Embossed matt Black	7,60	30

roundcapsule >> RJC/RJI End caps in Powder Coated Alumin. Wall Modern Line

H = mm	Art.	Finish	Variant	€ / set	set ■
6	RJC 60 A*	Pow. Coated	A13	10,99	2 pcs
8	RJC/RJI 80 A*	Pow. Coated	A13/A24/A25/A33/A34/A50/A60/A64/A65	10,99	2 pcs
10	RJC/RJI 100 A*	Pow. Coated	A13/A24/A25/A33/A34/A50/A60/A64/A65	10,99	2 pcs
11	RJC/RJI 110 A*	Pow. Coated	A13/A24/A25/A33/A34/A50/A60/A64/A65	10,99	2 pcs
12,5	RJC/RJI 125 A*	Pow. Coated	A13/A24/A25/A33/A34/A50/A60/A64/A65	10,99	2 pcs

RJC= outside corner; RJI= inside corner

☒ For quantities below 20pcs price increase by 10%



roundjolly RJ-A50 + RJC-A50



roundjolly RJ-A13 + RJI-A13

junction

wall covering



Length: 2,70 meters



RJ - P



RJC-P



RJI-P



P11 P12 P21 P22



P23 P31 P32 P41



P42 P43 P44 P45



P46 P51

The images are inserted purely for illustrative purposes

roundjolly >> RJ in Synthetic Resin Full Body Colored Resintop

H = mm	Art.	Finish	Variant	€ / m	pc ■
6	RJ 60 P11	Synthetic Resin	Pure White	1,79	20
8	RJ 80 P11	Synthetic Resin	Pure White	1,97	20
10	RJ 100 P11	Synthetic Resin	Pure White	2,16	20
6	RJ 60 P12	Synthetic Resin	White	1,79	20
8	RJ 80 P12	Synthetic Resin	White	1,97	20
10	RJ 100 P12	Synthetic Resin	White	2,16	20
6	RJ 60 P21	Synthetic Resin	Light Grey	1,79	20
8	RJ 80 P21	Synthetic Resin	Light Grey	1,97	20
10	RJ 100 P21	Synthetic Resin	Light Grey	2,16	20
6	RJ 60 P22	Synthetic Resin	Pastel Grey	1,79	20
8	RJ 80 P22	Synthetic Resin	Pastel Grey	1,97	20
10	RJ 100 P22	Synthetic Resin	Pastel Grey	2,16	20
6	RJ 60 P23	Synthetic Resin	Cement Grey	1,79	20
8	RJ 80 P23	Synthetic Resin	Cement Grey	1,97	20
10	RJ 100 P23	Synthetic Resin	Cement Grey	2,16	20
6	RJ 60 P31	Synthetic Resin	Beige Bahama	1,79	20
8	RJ 80 P31	Synthetic Resin	Beige Bahama	1,97	20
10	RJ 100 P31	Synthetic Resin	Beige Bahama	2,16	20
6	RJ 60 P32	Synthetic Resin	Dark Beige	1,79	20
8	RJ 80 P32	Synthetic Resin	Dark Beige	1,97	20
10	RJ 100 P32	Synthetic Resin	Dark Beige	2,16	20
6	RJ 60 P41	Synthetic Resin	Cream	1,79	20
8	RJ 80 P41	Synthetic Resin	Cream	1,97	20
10	RJ 100 P41	Synthetic Resin	Cream	2,16	20
6	RJ 60 P42	Synthetic Resin	Ivory	1,79	20
8	RJ 80 P42	Synthetic Resin	Ivory	1,97	20
10	RJ 100 P42	Synthetic Resin	Ivory	2,16	20
6	RJ 60 P43	Synthetic Resin	Peach	1,79	20
8	RJ 80 P43	Synthetic Resin	Peach	1,97	20
10	RJ 100 P43	Synthetic Resin	Peach	2,16	20
6	RJ 60 P44	Synthetic Resin	Soft Pink	1,79	20
8	RJ 80 P44	Synthetic Resin	Soft Pink	1,97	20
10	RJ 100 P44	Synthetic Resin	Soft Pink	2,16	20
6	RJ 60 P45	Synthetic Resin	Soft Blue	1,79	20
8	RJ 80 P45	Synthetic Resin	Soft Blue	1,97	20
10	RJ 100 P45	Synthetic Resin	Soft Blue	2,16	20
6	RJ 60 P46	Synthetic Resin	Soft Green	1,79	20
8	RJ 80 P46	Synthetic Resin	Soft Green	1,97	20
10	RJ 100 P46	Synthetic Resin	Soft Green	2,16	20
6	RJ 60 P51	Synthetic Resin	Black	1,79	20
8	RJ 80 P51	Synthetic Resin	Black	1,97	20
10	RJ 100 P51	Synthetic Resin	Black	2,16	20

☒ For quantities below 20pcs price increase by 10%



roundjolly RJ 100 P22



roundjolly RJI-P11

Length: 2,60 meters

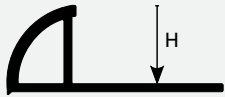

RJS - P*



The images are inserted purely for illustrative purposes

roundjolly >> RJS in PVC Coated "marble effect"

H = mm	Art.	Finish	Variant	€/m	pc
10	RJS 100 P82	PVC	White Marble	4,21	60
10	RJS 100 P83	PVC	Light Travertine	4,21	60
10	RJS 100 P84	PVC	Beige Travertine	4,21	60
10	RJS 100 P85	PVC	Navona	4,21	60
10	RJS 100 P86	PVC	Pink Beige	4,21	60
10	RJS 100 P87	PVC	Yellow Beige	4,21	60
10	RJS 100 P88	PVC	Caramel Beige	4,21	60
10	RJS 100 P89	PVC	Dove Beige	4,21	60
10	RJS 100 P90	PVC	Antique Pink	4,21	60
10	RJS 100 P91	PVC	Peach Pink	4,21	60
10	RJS 100 P92	PVC	Light Green	4,21	60
10	RJS 100 P93	PVC	Brasil Green	4,21	60
10	RJS 100 P94	PVC	Azure Blue	4,21	60
10	RJS 100 P95	PVC	Grey Marble	4,21	60

Profiles not equipped with end caps and junctions



roundjolly RJS-P*



roundjolly RJS-P94

Length: 2,70 meters

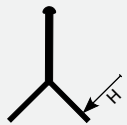

RJF - A



The images are inserted purely for illustrative purposes

filojolly >> RJF in Anodized Aluminum

H = mm	Art.	Finish	Variant	€/m	pc
3	RJF 30 AS	Anodized	Silver	4,81	50
4,4	RJF 44 AS	Anodized	Silver	5,01	50
6	RJF 60 AS	Anodized	Silver	5,17	50
8	RJF 80 AS	Anodized	Silver	5,50	50
10	RJF 100 AS	Anodized	Silver	5,99	50
12,5	RJF 125 AS	Anodized	Silver	6,34	40
20	RJF 200 AS	Anodized	Silver	7,90	40

filojolly >> RJF in Bright Polished Anodized Aluminum

H = mm	Art.	Finish	Variant	€/m	pc
3	RJF 30 ASB	Bright Polished Anodized	Chrome	8,09	50
4,4	RJF 44 ASB	Bright Polished Anodized	Chrome	8,40	50
6	RJF 60 ASB	Bright Polished Anodized	Chrome	8,64	50
8	RJF 80 ASB	Bright Polished Anodized	Chrome	9,20	50
10	RJF 100 ASB	Bright Polished Anodized	Chrome	10,30	50
12,5	RJF 125 ASB	Bright Polished Anodized	Chrome	10,83	40
4,4	RJF 44 AOB	Bright Polished Anodized	Gold	8,40	50

filojolly >> RJF in Bright Polished Anodized Aluminum

H = mm	Art.	Finish	Variant	€/m	pc
4,4	RJF 44 AOB	Bright Polished Anodized	Gold	8,40	50



filojolly RJF 44 ASB



filojolly RJF-AOB

☒ For quantities below 20pcs price increase by 10%
 ☒ Individually wrapped



Length: 2,70 meters

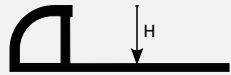

RJE - P*

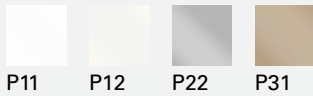

The images are inserted purely for illustrative purposes

roundjolly >> RJE in Synthetic Resin Full Body Colored Resintop

H = mm	Art.			Finish	Variant	€ / m	pc ■
6	RJE	60	P11	Synthetic Resin	Pure White	1,27	120
8	RJE	80	P11	Synthetic Resin	Pure White	1,34	100
10	RJE	100	P11	Synthetic Resin	Pure White	1,58	70
12,5	RJE	125	P11	Synthetic Resin	Pure White	1,67	50
6	RJE	60	P22	Synthetic Resin	Pastel Grey	1,27	120
8	RJE	80	P22	Synthetic Resin	Pastel Grey	1,34	100
10	RJE	100	P22	Synthetic Resin	Pastel Grey	1,58	70
12,5	RJE	125	P22	Synthetic Resin	Pastel Grey	1,67	50
6	RJE	60	P31	Synthetic Resin	Beige Bahama	1,27	120
8	RJE	80	P31	Synthetic Resin	Beige Bahama	1,34	100
10	RJE	100	P31	Synthetic Resin	Beige Bahama	1,58	70
12,5	RJE	125	P31	Synthetic Resin	Beige Bahama	1,67	50

roundjolly >> RJE "top line bicolor" resintop in bright painted effect

H = mm	Art.			Finish	Variant	€ / m	pc ■
6	RJE	60	PT11	Synthetic Resin	Pure White varnished polished	2,40	70
6	RJE	60	PT12	Synthetic Resin	White varnished polished	2,40	70
8	RJE	80	PT12	Synthetic Resin	White varnished polished	2,48	100
10	RJE	100	PT12	Synthetic Resin	White varnished polished	2,63	70
6	RJE	60	PT22	Synthetic Resin	Pastel Grey varnished polished	2,40	70
8	RJE	80	PT22	Synthetic Resin	Pastel Grey varnished polished	2,48	100
10	RJE	100	PT22	Synthetic Resin	Pastel Grey varnished polished	2,63	70
6	RJE	60	PT31	Synthetic Resin	Beige Bahama varnished polished	2,40	70
8	RJE	80	PT31	Synthetic Resin	Beige Bahama varnished polished	2,48	100
10	RJE	100	PT31	Synthetic Resin	Beige Bahama varnished polished	2,63	70

roundcapsule >> RJC/RJI End caps in Synthetic Resin

H = mm	Art.			Finish	Variant	€ / set	set ■
6	RJC/RJI	60	P*	Synthetic Resin	P11/P12/P22/P31	3,24	2 pcs
8	RJC/RJI	80	P*	Synthetic Resin	P11/P12/P22/P31	3,24	2 pcs
10	RJC/RJI	100	P*	Synthetic Resin	P11/P12/P22/P31	3,24	2 pcs
12,5	RJC	125	P*	Synthetic Resin	P11/P12/P22/P31	3,24	2 pcs



roundjolly RJE-P11

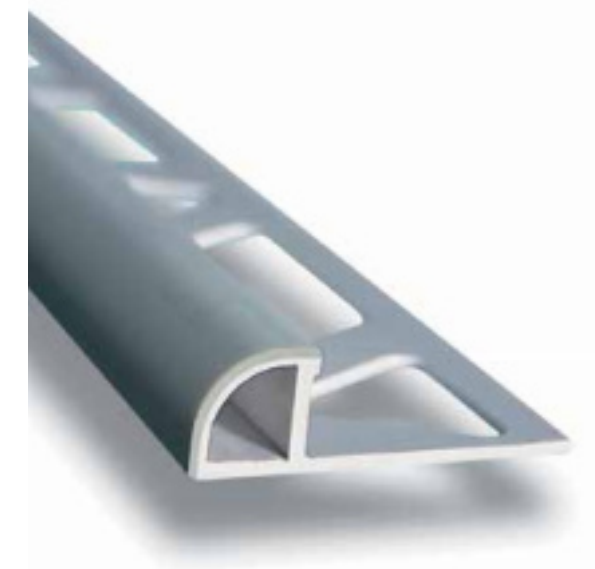

roundjolly RJE-P22

☒ For quantities below 20pcs price increase by 10%

Length: 2,70 meters

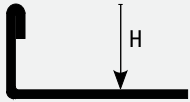

TR - I

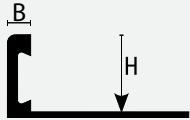

TR - A
B = 3 mm



IL/M IS IX AS

The images are inserted purely for illustrative purposes

trimtec >> TR in Stainless Steel AISI 304 - DIN 1.4301 - Polished

H = mm	Art.		Finish	€ / m	pc ■
4,5	TR	45 IL	Polished	8,67	30
6	TR	60 IL	Polished	9,12	30
8	TR	80 IL	Polished	9,40	30
10	TR	100 IL	Polished	9,78	30
11	TR	110 IL	Polished	10,07	30
12,5	TR	125 IL	Polished	10,30	30

trimtec >> TR in Stainless Steel AISI 316 - DIN 1.4404 - Polished

H = mm	Art.		Finish	€ / m	pc ■
6	TR	60 ILM	Polished	11,09	30
8	TR	80 ILM	Polished	11,31	30
10	TR	100 ILM	Polished	11,90	30
11	TR	110 ILM	Polished	12,16	30
12,5	TR	125 ILM	Polished	13,01	30

trimtec >> TR in Stainless Steel AISI 304 - DIN 1.4301 - Brushed

H = mm	Art.		Finish	€ / m	pc ■
4,5	TR	45 IS	Brushed	11,20	30
6	TR	60 IS	Brushed	11,67	30
8	TR	80 IS	Brushed	11,96	30
10	TR	100 IS	Brushed	12,34	30
11	TR	110 IS	Brushed	12,62	30
12,5	TR	125 IS	Brushed	12,88	30

trimtec >> TR in Stainless Steel AISI 304 - DIN 1.4301 - Sanded

H = mm	Art.		Finish	€ / m	pc ■
10	TR	100 IX	Sanded	12,91	30
11	TR	110 IX	Sanded	13,17	30
12,5	TR	125 IX	Sanded	13,44	30

trimtec >> TR in Anodized Aluminum

H = mm	Art.		Finish	Variant	€ / m	pc ■
4,5	TR	45 AS	Anodized	Silver	3,89	40
6	TR	60 AS	Anodized	Silver	4,04	40
8	TR	80 AS	Anodized	Silver	4,18	40
10	TR	100 AS	Anodized	Silver	4,38	40
11	TR	110 AS	Anodized	Silver	4,71	40
12,5	TR	125 AS	Anodized	Silver	5,01	40



trimtec TR 45 IL



trimtec TR 100 AS

finish

wall covering

For quantities below 20pcs price increase by 10%
 Individually wrapped



Length: 2,70 meters

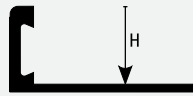

KJ - A

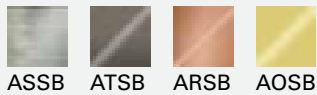
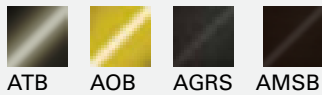

The images are inserted purely for illustrative purposes

kerajolly >> KJ in Anodized Aluminum

H = mm	Art.		Finish	Variant	€ / m	pc ■
6	KJ	60 AT	Anodized	Titan	5,63	40
8	KJ	80 AT	Anodized	Titan	5,77	40
10	KJ	100 AT	Anodized	Titan	6,04	40
12,5	KJ	125 AT	Anodized	Titan	6,74	40
6	KJ	60 AR	Anodized	Copper	5,63	40
8	KJ	80 AR	Anodized	Copper	5,77	40
10	KJ	100 AR	Anodized	Copper	6,04	40
12,5	KJ	125 AR	Anodized	Copper	6,74	40
10	KJ	100 AO	Anodized	Gold	6,04	40

kerajolly >> KJ in Brushed Anodized Aluminum

H = mm	Art.		Finish	Variant	€ / m	pc ■
6	KJ	60 AMSB	Brushed Anodized	Antique Bronze	12,62	40
8	KJ	80 AMSB	Brushed Anodized	Antique Bronze	12,76	40
10	KJ	100 AMSB	Brushed Anodized	Antique Bronze	12,97	40
12,5	KJ	125 AMSB	Brushed Anodized	Antique Bronze	13,11	40
8	KJ	80 AGRS	Brushed Anodized	Graphite	12,76	40
10	KJ	100 AGRS	Brushed Anodized	Graphite	12,97	40
12,5	KJ	125 AGRS	Brushed Anodized	Graphite	13,11	40

kerajolly >> KJ in Bright Polished Anodized Aluminum

H = mm	Art.		Finish	Variant	€ / m	pc ■
6	KJ	60 ASB	Bright Polished Anodized	Chrome	7,26	40
8	KJ	80 ASB	Bright Polished Anodized	Chrome	7,62	40
10	KJ	100 ASB	Bright Polished Anodized	Chrome	7,98	40
11	KJ	110 ASB	Bright Polished Anodized	Chrome	8,20	40
12,5	KJ	125 ASB	Bright Polished Anodized	Chrome	8,40	40
8	KJ	80 ATB	Bright Polished Anodized	Titan	7,88	40
10	KJ	100 ATB	Bright Polished Anodized	Titan	8,25	40
12,5	KJ	125 ATB	Bright Polished Anodized	Titan	8,37	40
6	KJ	60 AOB	Bright Polished Anodized	Gold	7,52	40
8	KJ	80 AOB	Bright Polished Anodized	Gold	7,88	40
10	KJ	100 AOB	Bright Polished Anodized	Gold	8,25	40
12,5	KJ	125 AOB	Bright Polished Anodized	Gold	8,37	40

kerajolly >> KJ in Bright Polished Brushed Aluminum

H = mm	Art.		Finish	Variant	€ / m	pc ■
6	KJ	60 ASSB	Bright Polished Brushed Anodized	Silver	11,25	40
8	KJ	80 ASSB	Bright Polished Brushed Anodized	Silver	11,38	40
10	KJ	100 ASSB	Bright Polished Brushed Anodized	Silver	11,59	40
12,5	KJ	125 ASSB	Bright Polished Brushed Anodized	Silver	11,72	40
6	KJ	60 ATSB	Bright Polished Brushed Anodized	Titan	11,25	40
8	KJ	80 ATSB	Bright Polished Brushed Anodized	Titan	11,38	40
10	KJ	100 ATSB	Bright Polished Brushed Anodized	Titan	11,59	40
12,5	KJ	125 ATSB	Bright Polished Brushed Anodized	Titan	11,72	40
10	KJ	100 ARSB	Bright Polished Brushed Anodized	Copper	11,59	40
12,5	KJ	125 ARSB	Bright Polished Brushed Anodized	Copper	11,72	40
10	KJ	100 AOSB	Bright Polished Brushed Anodized	Gold	11,59	40
12,5	KJ	125 AOSB	Bright Polished Brushed Anodized	Gold	11,72	40



kerajolly KJ 100 AT



kerajolly KJ-AGRS



kerajolly KJ 100 ASB

✘ For quantities below 20 pcs 10% price increase applied.

Individually wrapped



Length: 2,70 meters

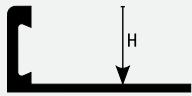

KJ - A

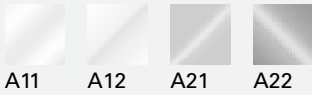

A11 A12 A21 A22

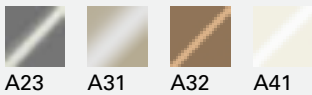

A23 A31 A32 A41

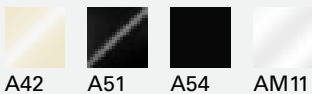

A42 A51 A54 AM11

The images are inserted purely for illustrative purposes

kerajolly >> KJ in Powder Coated Aluminum

	H = mm	Art.	Finish	Variant		pc ■
	6	KJ 60 A11	Pow. Coated	Pure White	5,42	40
	8	KJ 80 A11	Pow. Coated	Pure White	5,55	40
	10	KJ 100 A11	Pow. Coated	Pure White	6,06	40
	12,5	KJ 125 A11	Pow. Coated	Pure White	6,41	40
	6	KJ 60 A12	Pow. Coated	Ivory White	5,42	40
	8	KJ 80 A12	Pow. Coated	Ivory White	5,55	40
	10	KJ 100 A12	Pow. Coated	Ivory White	6,06	40
	12,5	KJ 125 A12	Pow. Coated	Ivory White	6,41	40
	6	KJ 60 A21	Pow. Coated	Light Grey	5,42	40
	8	KJ 80 A21	Pow. Coated	Light Grey	5,55	40
	10	KJ 100 A21	Pow. Coated	Light Grey	6,06	40
	12,5	KJ 125 A21	Pow. Coated	Light Grey	6,41	40
	6	KJ 60 A22	Pow. Coated	Pastel Grey	5,42	40
	8	KJ 80 A22	Pow. Coated	Pastel Grey	5,55	40
	10	KJ 100 A22	Pow. Coated	Pastel Grey	6,06	40
	12,5	KJ 125 A22	Pow. Coated	Pastel Grey	6,41	40
	6	KJ 60 A23	Pow. Coated	Cement Grey	5,42	40
	8	KJ 80 A23	Pow. Coated	Cement Grey	5,55	40
	10	KJ 100 A23	Pow. Coated	Cement Grey	6,06	40
	12,5	KJ 125 A23	Pow. Coated	Cement Grey	6,41	40
	6	KJ 60 A31	Pow. Coated	Beige Bahama	5,42	40
	8	KJ 80 A31	Pow. Coated	Beige Bahama	5,55	40
	10	KJ 100 A31	Pow. Coated	Beige Bahama	6,06	40
	12,5	KJ 125 A31	Pow. Coated	Beige Bahama	6,41	40
	6	KJ 60 A32	Pow. Coated	Dark Beige	5,42	40
	8	KJ 80 A32	Pow. Coated	Dark Beige	5,55	40
	10	KJ 100 A32	Pow. Coated	Dark Beige	6,06	40
	12,5	KJ 125 A32	Pow. Coated	Dark Beige	6,41	40
	6	KJ 60 A41	Pow. Coated	Cream	5,42	40
	8	KJ 80 A41	Pow. Coated	Cream	5,55	40
	10	KJ 100 A41	Pow. Coated	Cream	6,06	40
	12,5	KJ 125 A41	Pow. Coated	Cream	6,41	40
	6	KJ 60 A42	Pow. Coated	Ivory	5,42	40
	8	KJ 80 A42	Pow. Coated	Ivory	5,55	40
	10	KJ 100 A42	Pow. Coated	Ivory	6,06	40
	12,5	KJ 125 A42	Pow. Coated	Ivory	6,41	40
	6	KJ 60 A51	Pow. Coated	Black	5,42	40
	8	KJ 80 A51	Pow. Coated	Black	5,55	40
	10	KJ 100 A51	Pow. Coated	Black	6,06	40
	12,5	KJ 125 A51	Pow. Coated	Black	6,41	40
new	6	KJ 60 A54	Pow. Coated	Matt Black	5,43	40
new	8	KJ 80 A54	Pow. Coated	Matt Black	5,55	40
new	10	KJ 100 A54	Pow. Coated	Matt Black	6,06	40
new	12,5	KJ 125 A54	Pow. Coated	Matt Black	6,41	40
new	6	KJ 60 AM11	Pow. Coated	Matt White	5,43	40
new	8	KJ 80 AM11	Pow. Coated	Matt White	5,55	40
new	10	KJ 100 AM11	Pow. Coated	Matt White	6,06	40
new	12,5	KJ 125 AM11	Pow. Coated	Matt White	6,41	40



kerajolly KJ 100 A54



kerajolly KJ 100 AM11

For quantities below 20 pcs 10% price increase applied.
 Individually wrapped

finish

wall covering



Length: 2,70 meters

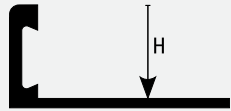

KJ - A



A13 A24 A25 A33



A34 A50 A60 A64



A65

The images are inserted purely for illustrative purposes

kerajolly >> KJ in Embossed Powder Coated Aluminum Modern Line

H = mm	Art.	Finish	Variant	€ / m	pc ■
8	KJ 80 A13	Pow. Coated	Embossed Antique White	5,55	40
10	KJ 100 A13	Pow. Coated	Embossed Antique White	6,06	40
11	KJ 110 A13	Pow. Coated	Embossed Antique White	6,23	40
12,5	KJ 125 A13	Pow. Coated	Embossed Antique White	6,41	40
8	KJ 80 A24	Pow. Coated	Embossed Pastel Grey	5,55	40
10	KJ 100 A24	Pow. Coated	Embossed Pastel Grey	6,06	40
11	KJ 110 A24	Pow. Coated	Embossed Pastel Grey	6,23	40
12,5	KJ 125 A24	Pow. Coated	Embossed Pastel Grey	6,41	40
8	KJ 80 A25	Pow. Coated	Embossed Cement Grey	5,55	40
10	KJ 100 A25	Pow. Coated	Embossed Cement Grey	6,06	40
11	KJ 110 A25	Pow. Coated	Embossed Cement Grey	6,23	40
12,5	KJ 125 A25	Pow. Coated	Embossed Cement Grey	6,41	40
8	KJ 80 A33	Pow. Coated	Embossed Dove-Grey	5,55	40
10	KJ 100 A33	Pow. Coated	Embossed Dove-Grey	6,06	40
11	KJ 110 A33	Pow. Coated	Embossed Dove-Grey	6,23	40
12,5	KJ 125 A33	Pow. Coated	Embossed Dove-Grey	6,41	40
8	KJ 80 A34	Pow. Coated	Embossed Kaki	5,55	40
10	KJ 100 A34	Pow. Coated	Embossed Kaki	6,06	40
11	KJ 110 A34	Pow. Coated	Embossed Kaki	6,23	40
12,5	KJ 125 A34	Pow. Coated	Embossed Kaki	6,41	40
8	KJ 80 A50	Pow. Coated	Embossed Micaceous	5,55	40
10	KJ 100 A50	Pow. Coated	Embossed Micaceous	6,06	40
11	KJ 110 A50	Pow. Coated	Embossed Micaceous	6,23	40
12,5	KJ 125 A50	Pow. Coated	Embossed Micaceous	6,41	40
8	KJ 80 A60	Pow. Coated	Embossed Corten	5,55	40
10	KJ 100 A60	Pow. Coated	Embossed Corten	6,06	40
11	KJ 110 A60	Pow. Coated	Embossed Corten	6,23	40
12,5	KJ 125 A60	Pow. Coated	Embossed Corten	6,41	40
8	KJ 80 A64	Pow. Coated	Embossed Dark Brown	5,55	40
10	KJ 100 A64	Pow. Coated	Embossed Dark Brown	6,06	40
11	KJ 110 A64	Pow. Coated	Embossed Dark Brown	6,23	40
12,5	KJ 125 A64	Pow. Coated	Embossed Dark Brown	6,41	40
8	KJ 80 A65	Pow. Coated	Embossed matt Black	5,55	40
10	KJ 100 A65	Pow. Coated	Embossed matt Black	6,06	40
11	KJ 110 A65	Pow. Coated	Embossed matt Black	6,23	40
12,5	KJ 125 A65	Pow. Coated	Embossed matt Black	6,41	40



kerajolly KJ-A25



kerajolly KJ-A50

⊗ For quantities below 20pcs price increase by 10%



Length: 2,70 meters

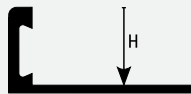

KJ - 0

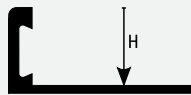

KJ - P

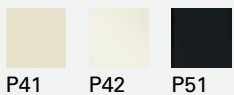
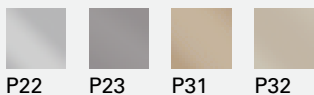
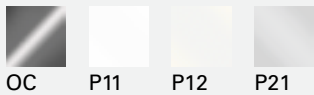

The images are inserted purely for illustrative purposes

kerajolly >> KJ in Chromed Brass

H = mm	Art.	Finish	€/ m	pc ■
6	KJ 60 OC	Chrome	17,95	20
8	KJ 80 OC	Chrome	19,03	20
10	KJ 100 OC	Chrome	19,78	20
12,5	KJ 125 OC	Chrome	21,18	20

kerajolly >> KJ Synthetic Resin Full Body Colored Resintop

H = mm	Art.	Finish	Variant	€/ m	pc ■
6	KJ 60 P11	Synthetic Resin	Pure White	1,76	170
8	KJ 80 P11	Synthetic Resin	Pure White	1,99	160
10	KJ 100 P11	Synthetic Resin	Pure White	2,20	150
12,5	KJ 125 P11	Synthetic Resin	Pure White	2,50	130
6	KJ 60 P12	Synthetic Resin	Ivory White	1,76	170
8	KJ 80 P12	Synthetic Resin	Ivory White	1,99	160
10	KJ 100 P12	Synthetic Resin	Ivory White	2,20	150
12,5	KJ 125 P12	Synthetic Resin	Ivory White	2,50	130
6	KJ 60 P21	Synthetic Resin	Light Grey	1,76	170
8	KJ 80 P21	Synthetic Resin	Light Grey	1,99	160
10	KJ 100 P21	Synthetic Resin	Light Grey	2,20	150
12,5	KJ 125 P21	Synthetic Resin	Light Grey	2,50	130
6	KJ 60 P22	Synthetic Resin	Pastel Grey	1,76	170
8	KJ 80 P22	Synthetic Resin	Pastel Grey	1,99	160
10	KJ 100 P22	Synthetic Resin	Pastel Grey	2,20	150
12,5	KJ 125 P22	Synthetic Resin	Pastel Grey	2,50	130
6	KJ 60 P23	Synthetic Resin	Cement Grey	1,76	170
8	KJ 80 P23	Synthetic Resin	Cement Grey	1,99	160
10	KJ 100 P23	Synthetic Resin	Cement Grey	2,20	150
12,5	KJ 125 P23	Synthetic Resin	Cement Grey	2,50	130
6	KJ 60 P31	Synthetic Resin	Beige Bahama	1,76	170
8	KJ 80 P31	Synthetic Resin	Beige Bahama	1,99	160
10	KJ 100 P31	Synthetic Resin	Beige Bahama	2,20	150
12,5	KJ 125 P31	Synthetic Resin	Beige Bahama	2,50	130
6	KJ 60 P32	Synthetic Resin	Dark Beige	1,76	170
8	KJ 80 P32	Synthetic Resin	Dark Beige	1,99	160
10	KJ 100 P32	Synthetic Resin	Dark Beige	2,20	150
12,5	KJ 125 P32	Synthetic Resin	Dark Beige	2,50	130
6	KJ 60 P41	Synthetic Resin	Cream	1,76	170
8	KJ 80 P41	Synthetic Resin	Cream	1,99	160
10	KJ 100 P41	Synthetic Resin	Cream	2,20	150
12,5	KJ 125 P41	Synthetic Resin	Cream	2,50	130
6	KJ 60 P42	Synthetic Resin	Ivory	1,76	170
8	KJ 80 P42	Synthetic Resin	Ivory	1,99	160
10	KJ 100 P42	Synthetic Resin	Ivory	2,20	150
12,5	KJ 125 P42	Synthetic Resin	Ivory	2,50	130
6	KJ 60 P51	Synthetic Resin	Black	1,76	170
8	KJ 80 P51	Synthetic Resin	Black	1,99	160
10	KJ 100 P51	Synthetic Resin	Black	2,20	150
12,5	KJ 125 P51	Synthetic Resin	Black	2,50	130



kerajolly KJ-OC



kerajolly KJ-P11

finish

wall covering

⊗ For quantities below 20pcs price increase by 10%



Length: 2,70 meters

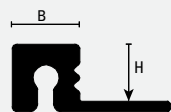

SJM 44 A
B = 5,1 mm



The images are inserted purely for illustrative purposes

mosaictec >> SJM for mosaic in Anodized Aluminum

H = mm	Art.	Finish	Variant	€ / m	pc ■
4,4	SJM 44 AS	Anodized	Silver	5,58	40

squarecapsule >> SJC End caps in Anodized Aluminum

H = mm	Art.	Finish	Variant	€ / set	set ■
4,4	SJC 44 AS	Anodized	Silver	11,03	2 pcs

mosaictec >> SJM for mosaic in Bright Polished Anodized Aluminum

H = mm	Art.	Finish	Variant	€ / m	pc ■
4,4	SJM 44 ASB	Bright Polished Anodized	Chrome	9,54	40
4,4	SJM 44 AOB	Bright Polished Anodized	Gold	9,54	40

squarecapsule >> SJC End cap in Bright Polished Anodized Aluminum

H = mm	Art.	Finish	Variant	€ / set	set ■
4,4	SJC 44 ASB	Bright Polished Anodized	Chrome	11,03	2 pcs
4,4	SJC 44 AOB	Bright Polished Anodized	Gold	11,03	2 pcs



mosaictec SJM-AS

Length: 2,70 meters



RJM 44 A



The images are inserted purely for illustrative purposes

mosaictec >> RJM in Anodized Aluminum

H = mm	Art.	Finish	Variant	€ / m	pc ■
4,4	RJM 44 AS	Anodized	Silver	6,16	40

mosaictec >> RJM in Bright Polished Anodized Aluminum

H = mm	Art.	Finish	Variant	€ / m	pc ■
4,4	RJM 44 ASB	Bright Polished Anodized	Chrome	9,47	40
4,4	RJM 44 AOB	Bright Polished Anodized	Gold	9,47	40



mosaictec RJM-AS

☒ For quantities below 20 pcs 10% price increase applied.
☑ Individually wrapped



Length: 2,70 meters



CRM 44 A



AS ASB AOB

The images are inserted purely for illustrative purposes

mosaictec >> CRM Cove for Mosaic in Anodized Aluminum

H = mm	Art.	Finish	Variant	€ / m	pc ■
4,4	CRM 44 AS	Anodized	Silver	8,00	40

mosaictec >> CRM Cove for mosaic in Bright Polished Anodized Aluminum

H = mm	Art.	Finish	Variant	€ / m	pc ■
4,4	CRM 44 ASB	Bright Polished Anodized	Chrome	11,49	40
4,4	CRM 44 AOB	Bright Polished Anodized	Gold	11,49	40



mosaictec CRM 44 AS

Length: 2,70 meters

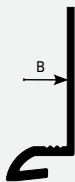

BT 45 A



AS ASB

The images are inserted purely for illustrative purposes

baseboard >> BT in Anodized Aluminum

B = mm	Art.	Finish	Variant	€ / m	pc ■
4,5	BT 45 AS	Anodized	Silver	7,64	40

baseboard >> BT in Bright Polished Anodized Aluminum

B = mm	Art.	Finish	Variant	€ / m	pc ■
4,5	BT 45 ASB	Bright Polished Anodized	Chrome	12,52	40



baseboard BT

☒ For quantities below 20pcs price increase by 10%
 ☒ Individually wrapped



Length: 2,70 meters

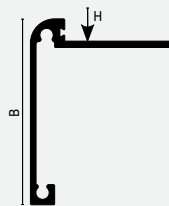

BP - A
B = 46 mm

planotec >> BP in Anodized Aluminum

H = mm	Art.	Finish	Variant	€ / m	pc ■
4,5	BP 45 AS	Anodized	Silver	13,06	10
10	BP 100 AS	Anodized	Silver	13,50	10
12,5	BP 125 AS	Anodized	Silver	13,95	10

planotec >> BPE* External caps in Anodized Aluminum

Art.	Finish	Variant	€ / set	set ■
BPE AS	Anodized	Silver	34,34	2 pcs



Length: 2,70 meters

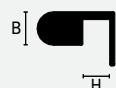

LIM 44 A
B = 4,5 mm

mosaitec >> LIM44 in Anodized Aluminum for mosaic

H = mm	Art.	Finish	Variant	€ / m	pc ■
4,3	LIM 44 AS	Anodized	Silver	6,65	40

mosaitec >> LIM44 for mosaic in Bright Polished Anodized Aluminum

H = mm	Art.	Finish	Variant	€ / m	pc ■
4,3	LIM 44 ASB	Bright Polished Anodized	Chrome	10,13	40
4,3	LIM 44 AOB	Bright Polished Anodized	Gold	10,13	40

plano+tec BP

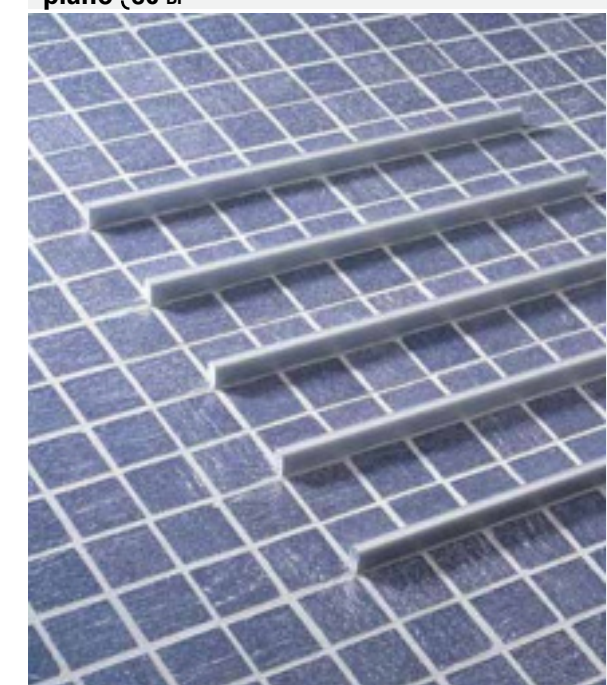

Length: 2,70 meters

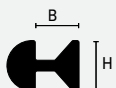

LIM 51 A
B = 5,1 mm

mosaitec >> LIM51 for mosaic in Anodized Aluminum

H = mm	Art.	Finish	Variant	€ / m	pc ■
5,1	LIM 51 AS	Anodized	Silver	5,02	40

mosaitec >> LIM51 for mosaic in Bright Polished Anodized Aluminum

H = mm	Art.	Finish	Variant	€ / m	pc ■
5,1	LIM 51 ASB	Bright Polished Anodized	Chrome	8,99	40
5,1	LIM 51 AOB	Bright Polished Anodized	Gold	8,99	40

mosaitec LIM44

☒ For quantities below 20pcs price increase by 10%
 Individually wrapped



Length: 2,70 meters

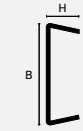

LI 20 I

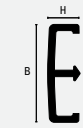

LI 22 A

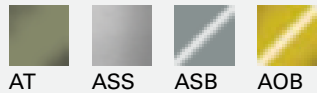
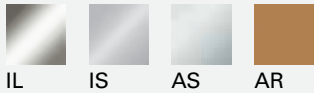

A51

The images are inserted purely for illustrative purposes

listec >> LI20 in Stainless Steel AISI 304 - DIN 1.4301 - Polished

HxB = mm	Art.	Finish	€ / m	pc ■
4,5 x 20	LI 20 IL	Polished	15,00	20

The width (3/4") coincides with the length of the glass mosaic, allowing the insertion of the strip without altering the course of the tiles but simply by replacing the tiles with the strip.

listec >> LI20 in Stainless Steel AISI 304 - DIN 1.4301 - Brushed

HxB = mm	Art.	Finish	€ / m	pc ■
4,5 x 20	LI 20 IS	Brushed	17,35	20

The width (3/4") coincides with the length of the glass mosaic, allowing the insertion of the strip without altering the course of the tiles but simply by replacing the tiles with the strip.

listec >> LI22 in Stainless Steel AISI 304 - DIN 1.4301 - Polished

HxB mm	Art.	Finish	€ / m	pc ■
7 x 22	LI 22 IL	Polished	15,65	20

listec >> LI22 in Stainless Steel AISI 304 - DIN 1.4301 - Brushed

HxB mm	Art.	Finish	€ / m	pc ■
7 x 22	LI 22 IS	Brushed	18,68	20

listec >> LI22 in Anodized Aluminum

HxB mm	Art.	Finish	Variant	€ / m	pc ■
6 x 22	LI 22 AS	Anodized	Silver	7,12	40 ☒
6 x 22	LI 22 AT	Anodized	Titan	8,22	40 ☒
6 x 22	LI 22 AR	Anodized	Copper	8,22	40 ☒

listec >> LI22 in Anodized Aluminum Brushed

HxB mm	Art.	Finish	Variant	€ / m	pc ■
6 x 22	LI 22 ASS	Brushed Anodized	Silver	8,22	40 ☒

listec >> LI22 in Bright Polished Anodized Aluminum

HxB mm	Art.	Finish	Variant	€ / m	pc ■
6 x 22	LI 22 ASB	Bright Polished Anodized	Chrome	10,15	40 ☒
6 x 22	LI 22 AOB	Bright Polished Anodized	Gold	10,15	40 ☒

listec >> LI22 in Powder Coated Aluminum

HxB mm	Art.	Finish	Variant	€ / m	pc ■
6 x 22	LI 22 A51	Pow. Coated	Black	5,84	40 ☒



listec LI 20 IS

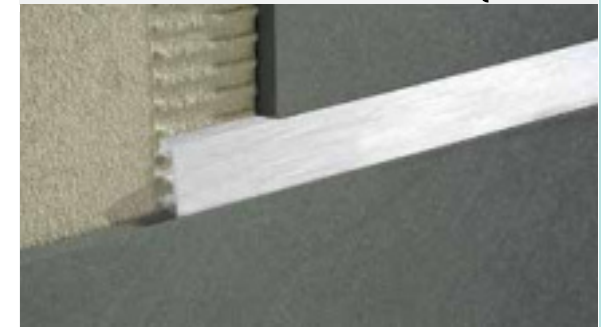

listec LI 22 ASS



listec LI 22 A51

☒ For quantities below 20pcs price increase by 10%
☒ Individually wrapped



Length: 2,70 meters

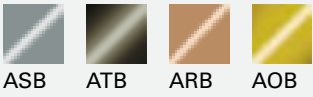
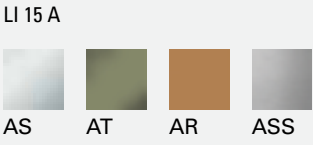

The images are inserted purely for illustrative purposes

listec >> LI in Anodized Aluminum

HxB mm	Art.	Finish	Variant	€ / m	pc ■
8 x 10	LI 10 AS	Anodized	Silver	5,67	40
8 x 15	LI 15 AS	Anodized	Silver	7,10	40
8 x 15	LI 15 AT	Anodized	Titan	8,22	40
8 x 15	LI 15 AR	Anodized	Copper	8,22	40

listec >> LI in Brushed Anodized Aluminum

HxB mm	Art.	Finish	Variant	€ / m	pc ■
8 x 10	LI 10 ASS	Brushed Anodized	Silver	6,56	40
8 x 15	LI 15 ASS	Brushed Anodized	Silver	8,22	40

listec >> LI in Bright Polished Anodized Aluminum

HxB mm	Art.	Finish	Variant	€ / m	pc ■
8 x 10	LI 10 ASB	Bright Polished Anodized	Chrome	7,85	40
8 x 15	LI 15 ASB	Bright Polished Anodized	Chrome	9,85	40
8 x 15	LI 15 ATB	Bright Polished Anodized	Titan	9,85	40
8 x 15	LI 15 ARB	Bright Polished Anodized	Copper	9,85	40
8 x 15	LI 15 AOB	Bright Polished Anodized	Gold	9,85	40

listec >> LI in Bright Polished Anodized Aluminum Grinded

HxB mm	Art.	Finish	Variant	€ / m	pc ■
8 x 15	LI 15 ASGB	Grinded Bright Polished Anodized	Silver	11,13	40

listec >> LI in Bright Polished Anodized Aluminum Brushed

HxB mm	Art.	Finish	Variant	€ / m	pc ■
8 x 15	LI 15 ASSB	Bright Polished Brushed Anodized	Silver	10,04	40

listec >> LI in Bright Polished Sanded Anodized Aluminum

HxB mm	Art.	Finish	Variant	€ / m	pc ■
8 x 15	LI 15 ASXB	Bright Polished Sanded Anodized	Silver	11,78	40
8 x 15	LI 15 ACXB	Bright Polished Sanded Anodized	Champagne	11,78	40

listec >> LI in Anodized Aluminum Glitter

HxB mm	Art.	Finish	Variant	€ / m	pc ■
8 x 10	LI 10 AGS	Anodized	Glitter Silver	24,20	40
8 x 10	LI 10 AGC	Anodized	Glitter Carbon	24,20	40
8 x 10	LI 10 AGO	Anodized	Glitter Gold	24,20	40

listec >> LI in Anodized Aluminum Soft Glitter

HxB mm	Art.	Finish	Variant	€ / m	pc ■
8 x 15	LI 15 AGSS	Anodized	Glitter Soft Silver	27,28	40
8 x 15	LI 15 AGSB	Anodized	Glitter Soft Bronze	27,28	40
8 x 15	LI 15 AGSM	Anodized	Glitter Soft Anthracite	27,28	40



listec LI 15 ASB



listec LI 10 AGS



listec LI 15 AGSB

For quantities below 20pcs price increase by 10%

Individually wrapped



Length: 2,70 meters



LI 15 A

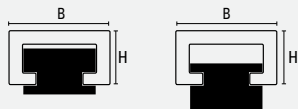

LI 15 A + LIA 15 AN

Compensates 8 to 9,5 mm
Compensates 8 to 11,5 mm



ATRS ATRO ATTK ATWE

The images are inserted purely for illustrative purposes

listec >> LI in High resistance Wood effect Aluminum

HxB mm	Art.	Finish	Variant	€/ m	pc ■
8 x 15	LI 15 ATRS	Wood Effect	Texture Bleached	11,33	40
8 x 15	LI 15 ATWE	Wood Effect	Texture Wengè	11,33	40
8 x 15	LI 15 ATTK	Wood Effect	Texture Teak	11,33	40
8 x 15	LI 15 ATRO	Wood Effect	Texture Oak	11,33	40

listec >> LIA compensating shims for listellos in Anodized Aluminum LI 15 A*

B = mm	Art.	Finish	€/ pc	pc ■
15	LIA 15 AN	Natural	1,90	5

It is advisable to use 5 pcs for a profile of 2.70 m



listec LI 15 ATWE

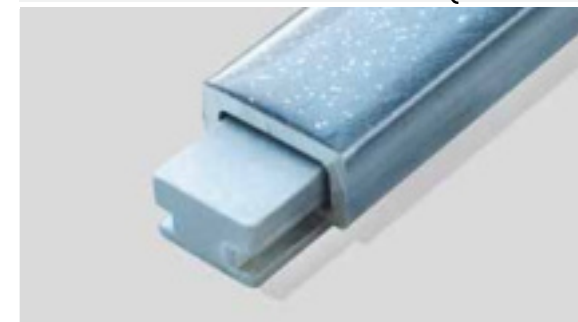

listec LIA 15 AN

Length: 2,70 meters

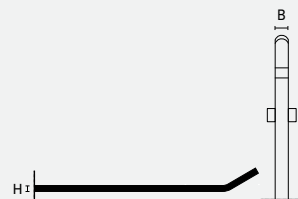

APP 15 A



ASB ASXB ACXB

The images are inserted purely for illustrative purposes

appendo >> APP in Anodized Aluminum

HxB mm	Art.	Finish	Variant	€/ m	pc ■
8 x 15	APP 15 ASB	Bright Polished Anodized	Chrome	36,40	1

appendo >> APP in Bright Polished Anodized Aluminum

HxB mm	Art.	Finish	Variant	€/ m	pc ■
8 x 15	APP 15 ASXB	Bright Polished Sanded Anodized	Silver	30,26	1
8 x 15	APP 15 ACXB	Bright Polished Sanded Anodized	Champagne	30,26	1

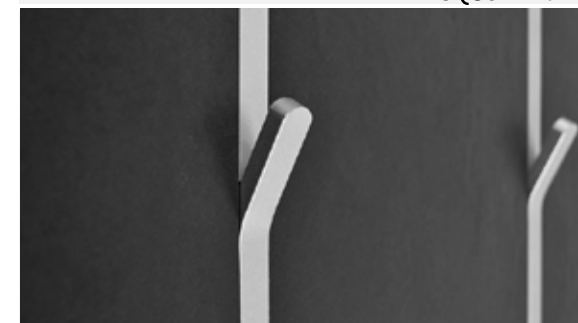

appendo APP 15 ASXB

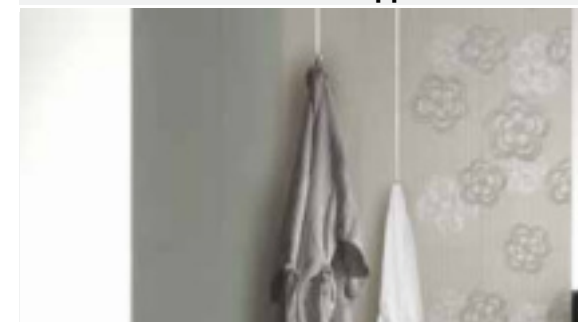

appendo APP

For quantities below 20pcs price increase by 10%
 Individually wrapped



Length: 2,70 meters



SJQ - A



SJC-A



AS ASB

The images are inserted purely for illustrative purposes

squarejolly >> SJQ in Anodized Aluminum

H = mm	Art.	Finish	Variant	€ / m	pc ■
8	SJQ 80 AS	Anodized	Silver	5,83	40
10	SJQ 100 AS	Anodized	Silver	6,34	40

squarecapsule >> SJC End cap in Anodized Aluminum

H = mm	Art.	Finish	Variant	€ / set	set ■
8	SJC 80 AS	Anodized	Silver	10,99	2 pcs
10	SJC 100 AS	Anodized	Silver	10,99	2 pcs

Universal end caps (internal and external corner, and three-way intersection). Loose pcs not available.

squarejolly >> SJQ in Bright Polished Anodized Aluminum

H = mm	Art.	Finish	Variant	€ / m	pc ■
8	SJQ 80 ASB	Bright Polished Anodized	Chrome	9,32	40
10	SJQ 100 ASB	Bright Polished Anodized	Chrome	10,41	40

squarecapsule >> SJC End caps in Bright Polished Anodized Aluminum

H = mm	Art.	Finish	Variant	€ / set	set ■
8	SJC 80 ASB	Bright Polished Anodized	Chrome	10,99	2 pcs
10	SJC 100 ASB	Bright Polished Anodized	Chrome	10,99	2 pcs

Universal end caps (internal and external corner, and three-way intersection). Loose pcs not available.



squarejolly SJQ-AS

Length: 2,70 meters



TJ - A



AS

The images are inserted purely for illustrative purposes

trialjolly >> TJ in Anodized Aluminum

H = mm	Art.	Finish	Variant	€ / m	pc ■
8	TJ 80 AS	Anodized	Silver	5,42	40
10	TJ 100 AS	Anodized	Silver	5,93	40
12,5	TJ 125 AS	Anodized	Silver	6,67	30

trialjolly >> TJC corner capsule in anodized aluminum

H = mm	Art.	Finish	Variant	€ / set	set ■
8	TJC 80 AS	Anodized	Silver	16,08	2 pcs
10	TJC 100 AS	Anodized	Silver	16,08	2 pcs
12,5	TJC 125 AS	Anodized	Silver	16,08	2 pcs

Loose pcs not available.

trialjolly >> TJT Flat end caps in Anodized Aluminum

H = mm	Art.	Finish	Variant	€ / set	set ■
8	TJT 80 AS	Anodized	Silver	15,73	2 pcs
10	TJT 100 AS	Anodized	Silver	15,73	2 pcs
12,5	TJT 125 AS	Anodized	Silver	15,73	2 pcs

Loose pcs not available.



trialjolly TJ-AS

For quantities below 20pcs price increase by 10%

Individually wrapped



Length: 2,70 meters

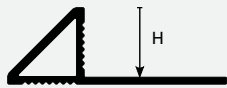

TJ - A



ASB

The images are inserted purely for illustrative purposes

trialjolly >> TJ in Bright Polished Anodized Aluminum

H = mm	Art.			Finish	Variant	€ / m	pc ■
8	TJ	80	ASB	Bright Polished Anodized	Chrome	9,00	40
10	TJ	100	ASB	Bright Polished Anodized	Chrome	10,03	40
12,5	TJ	125	ASB	Bright Polished Anodized	Chrome	11,28	30

trialjolly >> TJC corner capsule in bright anodized aluminum

H = mm	Art.			Finish	Variant	€ / set	set ■
8	TJC	80	ASB	Bright Polished Anodized	Chrome	16,08	2 pcs
10	TJC	100	ASB	Bright Polished Anodized	Chrome	16,08	2 pcs
12,5	TJC	125	ASB	Bright Polished Anodized	Chrome	16,08	2 pcs

Loose pcs not available.

trialjolly >> TJT End cap in Bright Polished Anodized Aluminum

H = mm	Art.			Finish	Variant	€ / set	set ■
8	TJT	80	ASB	Bright Polished Anodized	Chrome	15,73	2 pcs
10	TJT	100	ASB	Bright Polished Anodized	Chrome	15,73	2 pcs
12,5	TJT	125	ASB	Bright Polished Anodized	Chrome	15,73	2 pcs

Loose pcs not available.



trialjolly TJ-ASB

Length: 2,70 meters

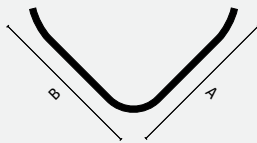

RO - I
RO - O

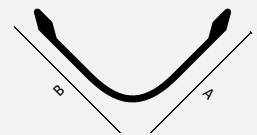

RO 25 A

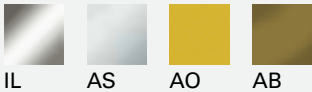

A11

The images are inserted purely for illustrative purposes

roundcorner >> RO in Stainless Steel AISI 304 - DIN 1.4301 - Self-Adhesive

H = mm	Art.			Finish	Variant	€ / m	pc ■
25 x 25	RO	25	ILA	Polished	Self-Adhesive	11,38	20
30 x 30	RO	30	ILA	Polished	Self-Adhesive	17,38	10
40 x 40	RO	40	ILA	Polished	Self-Adhesive	21,71	10
50 x 50	RO	50	ILA	Polished	Self-Adhesive	25,41	10

RO25x25mm - thickness 10/10; starting from size 30x30mm - thickness 12/10; protected with a removable film.

roundcorner >> RO in Anodized Aluminum - Self-Adhesive

H = mm	Art.			Finish	Variant	€ / m	pc ■
25 x 25	RO	25	ASA	Anodized	Silver Self-Adhesive	8,34	20
25 x 25	RO	25	AOA	Anodized	Gold Self-Adhesive	8,34	20
25 x 25	RO	25	ABA	Anodized	Bronze Self-Adhesive	8,34	20

roundcorner >> RO in Powder Coated Aluminum - Self-Adhesive

H = mm	Art.			Finish	Variant	€ / m	pc ■
25 x 25	RO	25	A11A	Pow. Coated	Pure White - Self-Adhesive	10,08	20

roundcorner >> RO in brass- adhesive

H = mm	Art.			Finish	€ / m	pc ■
25 x 25	RO	25	OLA	Polished	15,33	20
30 x 30	RO	30	OLA	Polished	25,44	10
40 x 40	RO	40	OLA	Polished	31,14	10
50 x 50	RO	50	OLA	Polished	36,88	10

Thickness 10/10 protectec by plastic film.



roundcorner RO

- For quantities below 20pcs price increase by 10%
- Individually wrapped

round corner edge

wall covering



Length: 2,70 meters

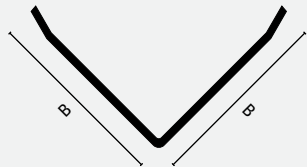

CO 25 I
CO 25 O



CO 25 A



IL IS AS AO



AB A11 OL

The images are inserted purely for illustrative purposes

keracomer >> CO in stainless steel 304 brushed with adhesive

B = mm	Art.	Finish	€ / m	pc ■
25 x 25	CO 25 ILA	Polished	10,53	20
30 x 30	CO 30 ILA	Polished	16,17	10
40 x 40	CO 40 ILA	Polished	19,48	10
50 x 50	CO 50 ILA	Polished	22,56	10

keracomer >> CO in stainless steel 304 Bright with adhesive

B = mm	Art.	Finish	€ / m	pc ■
30 x 30	CO 30 ISA	Brushed	21,79	10

Thickness 10/10 - protected with a removable film.

keracomer >> CO in Anodized Aluminum - Self-Adhesive

B = mm	Art.	Finish	Variant	€ / m	pc ■
25 x 25	CO 25 ASA	Anodized	Silver Self-Adhesive	7,14	20
25 x 25	CO 25 AOA	Anodized	Gold Self-Adhesive	7,14	20
25 x 25	CO 25 ABA	Anodized	Bronze Self-Adhesive	7,14	20

keracomer >> CO in Powder Coated Aluminum - Self-Adhesive

B = mm	Art.	Finish	Variant	€ / m	pc ■
25 x 25	CO 25 A11A	Pow. Coated	Pure White - Self-Adhesive	8,88	20

keracomer >> CO in Brass - Self-Adhesive

B = mm	Art.	Finish	€ / m	pc ■
25 x 25	CO 25 OLA	Polished	14,46	20
30 x 30	CO 30 OLA	Polished	22,13	20
40 x 40	CO 40 OLA	Polished	28,05	10
50 x 50	CO 50 OLA	Polished	35,00	10

CO 25x25mm - thickness 10/10; starting from size 30x30mm - thickness 12/10. Protected with a removable film.

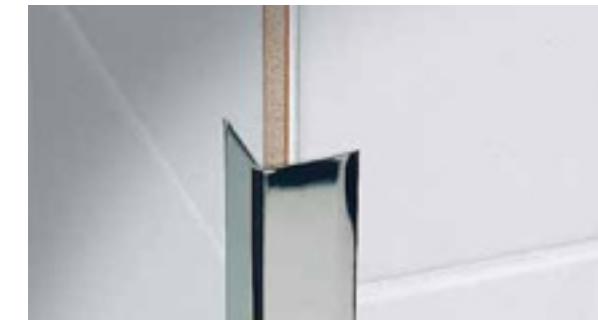

keracomer co



wallprotection wa

Length: 2,70 meters



WA 60 P

wallprotection >> WA synthetic resin full body bicolor

B = mm	Art.	Finish	Variant	€ / m	pc ■
60 x 60	WA 60 P11/22	Synthetic Resin	White/Pastel Grey	12,71	15
60 x 60	WA 60 P11/11	Synthetic Resin	White/Pure White	12,71	15
60 x 60	WA 60 P22/22	Synthetic Resin	Grey/Pastel Grey	12,71	15

Other colors are available on request min. 1000 m. See RJ-P series colors pag. 60 combinable with each other to obtain a Bicolor effect.



wallprotection WP 125 P11/P22

Length: 2,70 meters

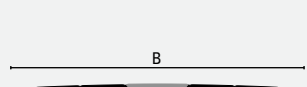

WP 125 P

wallprotection >> WP in Synthetic Resin Full Body Colored Resintop

B = mm	Art.	Finish	Variant	€ / m	pc ■
125	WP 125 P11/22	Synthetic Resin	White/Pastel Grey	12,71	20
125	WP 125 P11/11	Synthetic Resin	White/Pure White	12,71	20
125	WP 125 P22/22	Synthetic Resin	Grey/Pastel Grey	12,71	20

✘ For quantities below 20pcs price increase by 10%

Individually wrapped



Length: 2,70 meters

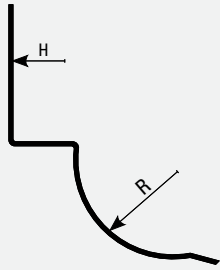

RS - IL
R = 16 mm

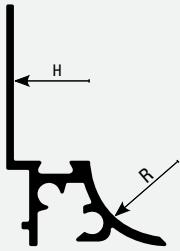

RS - A*
R = 10 mm

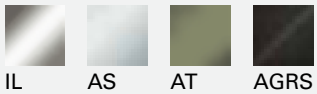

The images are inserted purely for illustrative purposes

sanitec >> RS in Stainless Steel AISI 304 - DIN 1.4301

H = mm	Art.	Finish	€ / m	pc ■
8	RS 80 IL	Polished	18,72	30
10	RS 100 IL	Polished	19,32	30
12,5	RS 125 IL	Polished	20,07	30

sanitec >> RSI-RSE Inside/Outside Corners for RS in stainless steel - Floor

H = mm	Art.	Finish	€ / pc	set ■
	RSI IL	Polished	29,09	2 pcs
	RSE IL	Polished	29,09	2 pcs

sanitec >> RSIR-RSER Inside/Outside Corners for RS in stainless steel - Wall

Art.	Finish	€ / pc	set ■
RSIR IL	Polished	29,09	2 pcs
RSER IL	Polished	29,09	2 pcs

sanitec >> RS in anodized aluminum

H = mm	Art.	Finish	Variant	€ / m	pc ■
<small>new</small> 8	RS 80 AS	Anodized	Silver	10,46	30
<small>new</small> 10	RS 100 AS	Anodized	Silver	10,72	30
<small>new</small> 12,5	RS 125 AS	Anodized	Silver	11,08	30
<small>new</small> 8	RS 80 AT	Anodized	Titan	14,13	30
<small>new</small> 10	RS 100 AT	Anodized	Titan	14,47	30
<small>new</small> 12,5	RS 125 AT	Anodized	Titan	14,95	30

sanitec >> RSI-RSE Inside/Outside Corners for RS in anodized aluminum - Wall

Art.	Finish	€ / pc	set ■
<small>new</small> RSI AS	Anodized	15,37	1 pc
<small>new</small> RSI AT	Anodized	17,68	1 pc
<small>new</small> RSE AS	Anodized	15,37	1 pc
<small>new</small> RSE AT	Anodized	17,68	1 pc

sanitec >> RSF end cap in anodized aluminum

Art.	Finish	€ / pc	set ■
<small>new</small> RSF AS	Anodized	8,43	2 pcs
<small>new</small> RSF AT	Anodized	9,42	2 pcs

sanitec >> RS in brushed aluminum

H = mm	Art.	Finish	Variant	€ / m	pc ■
<small>new</small> 8	RS 80 AGRS	Brushed Anodized	Graphite	21,88	30
<small>new</small> 10	RS 100 AGRS	Brushed Anodized	Graphite	22,40	30
<small>new</small> 12,5	RS 125 AGRS	Brushed Anodized	Graphite	23,14	30

sanitec >> RSI-RSE Inside/Outside Corners for RS in brushed aluminum -Wall

Art.	Finish	€ / pc	set ■
<small>new</small> RSI AGRS	Brushed Anodized	23,67	1 pc
<small>new</small> RSE AGRS	Brushed Anodized	23,67	1 pc

sanitec >> RSF end cap in bright brushed aluminum

Art.	Finish	€ / pc	set ■
<small>new</small> RSF AGRS	Brushed Anodized	12,61	2 pcs

☒ For quantities below 20 pcs 10% price increase applied.



sanitec RS-IL



sanitec RS-AS + RSF

cove raccord, corner

wall covering



Length: 2,70 meters

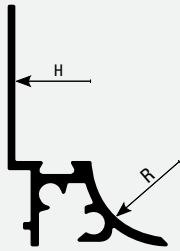

RS - A*
R = 10 mm



ASSB ATSB

The images are inserted purely for illustrative purposes

sanitec >> RS in bright brushed aluminum

	H = mm	Art.		Finish	Variant	€ / m	pc ■
new	8	RS 80	ASSB	Bright Polished Brushed Anodized	Silver	19,89	30
new	10	RS 100	ASSB	Bright Polished Brushed Anodized	Silver	20,36	30
new	12,5	RS 125	ASSB	Bright Polished Brushed Anodized	Silver	21,04	30
new	8	RS 80	ATSB	Bright Polished Brushed Anodized	Titan	21,88	30
new	10	RS 100	ATSB	Bright Polished Brushed Anodized	Titan	22,40	30
new	12,5	RS 125	ATSB	Bright Polished Brushed Anodized	Titan	23,14	30

sanitec >> RSI-RSE Inside/Outside Corners for RS in bright brushed aluminum - Wall

	Art.		Finish	€ / pc	set ■
new	RSI	ASSB	Bright Polished Brushed Anodized	21,52	1 pc
new	RSI	ATSB	Bright Polished Brushed Anodized	23,67	1 pc
new	RSE	ASSB	Bright Polished Brushed Anodized	21,52	1 pc
new	RSE	ATSB	Bright Polished Brushed Anodized	23,67	1 pc

sanitec >> RSF end cap in bright brushed aluminum

	Art.		Finish	€ / pc	set ■
new	RSF	ASSB	Bright Polished Brushed Anodized	11,47	2 pcs
new	RSF	ATSB	Bright Polished Brushed Anodized	12,61	2 pcs



sanitec RS 100 ATSB

Length: 2,70 meters

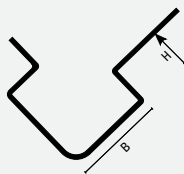

RE - IL
B = 25 mm



IL

The images are inserted purely for illustrative purposes

roundcorner >> RE in Stainless Steel AISI 304 - DIN 1.4301 - 25x25 mm

	H = mm	Art.		Finish	€ / m	pc ■
	8	RE 80	IL	Polished	19,50	10
	10	RE 100	IL	Polished	20,21	10
	12,5	RE 125	IL	Polished	20,84	10

Thickness 10/10 - protected with a removable film.



roundcorner RE

✗ For quantities below 20 pcs 10% price increase applied.

Length: 2,70 meters

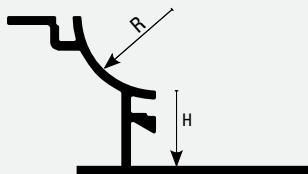

RT A*
R = 10 mm

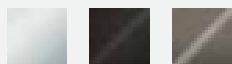

AS AGRS ATSB

The images are inserted purely for illustrative purposes

sanitec >> RT in Anodized Aluminum

	H = mm	Art.	Finish	Variant	€ / m	pc ■
new	8	RT 80 AS	Anodized	Silver	10,46	30
new	10	RT 100 AS	Anodized	Silver	10,72	30
new	12,5	RT 125 AS	Anodized	Silver	11,08	30

sanitec >> RTI-RTE Inside/Outside Corners for RT in Anodized Aluminum

	Art.	Finish	€ / set	set ■
new	RTI AS	Anodized	15,37	1 pc
new	RTE AS	Anodized	15,37	1 pc
new	SBF 10 AS	Anodized	16,02	2 pcs

sanitec >> RT in Brushed Aluminum

	H = mm	Art.	Finish	Variant	€ / m	pc ■
new	8	RT 80 AGRS	Brushed Anodized	Graphite	21,88	30
new	10	RT 100 AGRS	Brushed Anodized	Graphite	22,40	30
new	12,5	RT 125 AGRS	Brushed Anodized	Graphite	23,14	30

sanitec >> RTI-RTE Inside/Outside Corners for RT in Brushed Aluminum

	Art.	Finish	€ / set	set ■
new	RTI AGRS	Brushed Anodized	23,67	1 pc
new	RTE AGRS	Brushed Anodized	23,67	1 pc
new	SBF 10 AGRS	Brushed Anodized	23,81	2 pcs

sanitec >> RT in Bright Brushed Aluminum

	H = mm	Art.	Finish	Variant	€ / m	pc ■
new	8	RT 80 ATSB	Bright Polished Brushed Anodized	Titan	21,88	30
new	10	RT 100 ATSB	Bright Polished Brushed Anodized	Titan	22,40	30
new	12,5	RT 125 ATSB	Bright Polished Brushed Anodized	Titan	23,14	30

sanitec >> RTI-RTE Inside/Outside Corners for RT in Bright Brushed Aluminum

	Art.	Finish	€ / set	set ■
new	RTI ATSB	Bright Polished Brushed Anodized	23,67	1 pc
new	RTE ATSB	Bright Polished Brushed Anodized	23,67	1 pc
new	SBF 10 ATSB	Bright Polished Brushed Anodized	23,81	2 pcs



sanitec RT 100 AGRS



sanitec RT 100 AS + RTE AS



sanitec RT 100 ATSB + RTIATSB



sanitec RT 100 AGRS + RTE AGRS

☒ For quantities below 20 pcs 10% price increase applied.



Length: 2,70 meters

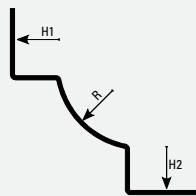

SB - I
R = 16 mm



IL IX

The images are inserted purely for illustrative purposes

sanitec >> SB in stainless steel aisi304 din 14301

H1/H2 mm	Art.	Finish	€/ m	pc ■
8/8	SB 80 IL	Polished	16,90	10
10/10	SB 100 IL	Polished	17,53	10
12,5/12,5	SB 125 IL	Polished	18,20	10
8/10	SB 80/100 IL	Polished	17,24	10
8/12,5	SB 80/125 IL	Polished	17,51	10
10/12,5	SB 100/125 IL	Polished	17,94	10

Profile protected with a removable film.

sanitec >> SB in Stainless Steel AISI 304 - DIN 1.4301 -Sanded

H1/H2 mm	Art.	Finish	€/ m	pc ■
10/10	SB 100 IX	Sanded	21,96	10

sanitec >> SBI Internal corner in stainless steel AISI 304 - DIN. 1.4301

Art.	Finish	€/ set	set ■
SBI IL	Polished	29,09	2 pcs
SBI IX	Sanded	29,09	2 pcs

sanitec >> SBE External corner in stainless steel AISI 304 - DIN. 1.4301

Art.	Finish	€/ set	set ■
SBE IL	Polished	29,09	2 pcs
SBE IX	Sanded	29,09	2 pcs

sanitec >> SBT Three ways corner in stainless steel AISI 304 - DIN. 1.4301

Art.	Finish	€/ set	set ■
SBT IL	Polished	43,24	2 pcs
SBT IX	Sanded	43,24	2 pcs



sanitec SB - IL

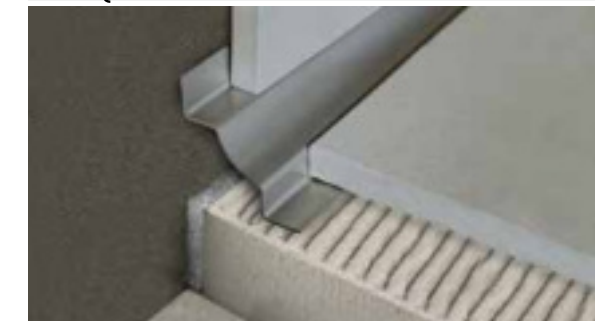

sanitec SB 100 IX

Length: 2,70 meters

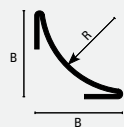

SB 15 IL
R = 16 mm

sanitec >> SB 15 in Stainless Steel AISI 304 - DIN 1.4301

B = mm	Art.	Finish	€/ m	pc ■
15 x 15	SB 15 IL	Polished	13,91	10

Profile protected with a removable film.



sanitec SB 15 IL

Length: 2,70 meters

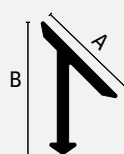

SB 12 A

sanitec >> SB 12 in Anodized Aluminum

H/H1 mm	Art.	Finish	Variant	€/ m	pc ■
12 x 15,2	SB 12 AS	Anodized	Silver	5,73	20

sanitec >> SB 12 in Bright Polished Anodized Aluminum

H/H1 mm	Art.	Finish	Variant	€/ m	pc ■
12 x 15,2	SB 12 ASB	Bright Polished Anodized	Chrome	9,14	20



sanitec SB 12 AS

✘ For quantities below 20 pcs 10% price increase applied.

☑ Individually wrapped



Length: 2,70 meters

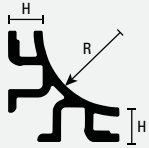

SB 10 A

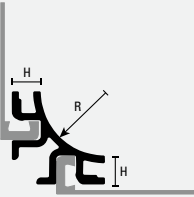

SB 10 + TR

The SB10 can be used alone, for 4.5 mm thick tiles, and in combination with the TR or KJ profiles for greater thicknesses.



AS ASB

The images are inserted purely for illustrative purposes

sanitec >> SB 10 in Anodized Aluminum

H = mm	Art.	Finish	Variant	€ / m	pc ■
4,5	SB 10 AS	Anodized	Silver	6,93	40

sanitec >> SB joints and corners in anodized aluminum

H = mm	Art.	Finish	Variant	€ / pc	set ■
4,5	SBT 10 AS	Anodized	Silver	18,10	1 pc
4,5	SBI 10 AS	Anodized	Silver	23,70	1 pc
4,5	SBE 10 AS	Anodized	Silver	24,59	1 pc
4,5	SBES 10 AS	Anodized	Silver	17,61	1 pc
4,5	SBF 10 AS	Anodized	Silver	16,02	2 pcs

sanitec >> SB 10 in Bright Polished Anodized Aluminum

H = mm	Art.	Finish	Variant	€ / m	pc ■
4,5	SB 10 ASB	Anodized	Chrome	11,12	40

sanitec >> SB joints and corners in bright anodized aluminum

H = mm	Art.	Finish	Variant	€ / pc	set ■
4,5	SBT 10 ASB	Bright Polished Anodized	Chrome	18,85	1 pc
4,5	SBI 10 ASB	Bright Polished Anodized	Chrome	24,57	1 pc
4,5	SBE 10 ASB	Bright Polished Anodized	Chrome	25,47	1 pc
4,5	SBES 10 ASB	Bright Polished Anodized	Chrome	18,33	1 pc
4,5	SBF 10 ASB	Bright Polished Anodized	Chrome	17,45	2 pcs



sanitec SB 10 + TR

Length: 2,70 meters

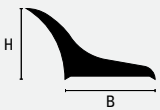

SB 20 A



AS A11

The images are inserted purely for illustrative purposes

sanitec >> SB 20 in Anodized Aluminum - Self-Adhesive

HxB mm	Art.	Finish	Variant	€ / m	pc ■
12 x 14	SB 20 ASA	Anodized	Silver Self-Adhesive	7,98	30

sanitec >> SB 20 in Anodized Aluminum - not Adhesive

HxB mm	Art.	Finish	Variant	€ / m	pc ■
12 x 14	SB 20 ASN	Anodized	Silver - not Self-Adhesive	6,52	30

sanitec >> SB 20 in Powder Coated Aluminum - Self-Adhesive

HxB mm	Art.	Finish	Variant	€ / m	pc ■
12 x 14	SB 20 A11A	Pow. Coated	Pure White - Self-Adhesive	8,86	30

sanitec >> SB 20 in Powder Coated Aluminum - not Adhesive

HxB mm	Art.	Finish	Variant	€ / m	pc ■
12 x 14	SB 20 A11N	Pow. Coated	Pure White -not Adhesive	7,40	30



sanitec SB 20 A11

For quantities below 20pcs price increase by 10%
 Individually wrapped



Length: 2,70 meters

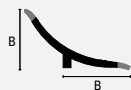

SB 24 P

sanitec >> SB 24 in Synthetic Resin Full Body Colored Resinil

B = mm	Art.	Finish	Variant	€ / m	pc ■
11 x 11	SB 24 P11	Synthetic Resin	Pure White+Trasparent lips	4,20	40

Length: 2,70 meters

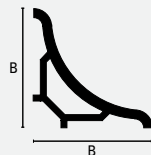

SB - P

sanitec >> SB in Synthetic Resin Full Body Colored Resinil

B = mm	Art.	Finish	Variant	€ / m	pc ■
20 x 20	SB 30 P11	Synthetic Resin	Pure White	4,89	40
45 x 45	SB 65 P11	Synthetic Resin	Pure White	9,00	40
20 x 20	SB 30 P22	Synthetic Resin	Pastel Grey	4,89	40
20 x 20	SB 30 P30	Synthetic Resin	Dark Beige	4,89	40



SBI 30 P

SBE 30 P

sanitec >> SBI/SBE/SBF/SBG Raccords and Accessories

B = mm	Art.	Finish	€ / set	set ■
20x20	SBI 30 P11	Internal corner junction	13,08	5 pcs
20x20	SBI 30 P22	Internal corner junction	13,08	5 pcs
20x20	SBI 30 P30	Internal corner junction	13,08	5 pcs
20x20	SBE 30 P11	External corner junction	13,08	5 pcs
20x20	SBE 30 P22	External corner junction	13,08	5 pcs
20x20	SBE 30 P30	External corner junction	13,08	5 pcs
20x20	SBF 30 P11	End-cap	13,08	5 pcs
20x20	SBF 30 P22	End-cap	13,08	5 pcs
20x20	SBF 30 P30	End-cap	13,08	5 pcs
20x20	SBG 30 P11	Junction	13,08	5 pcs
20x20	SBG 30 P22	Junction	13,08	5 pcs
20x20	SBG 30 P30	Junction	13,08	5 pcs



SBF 30 P

SBG 30 P

non tradotto

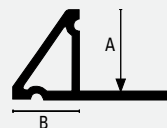

SB 18 P

sanitec >> SB 18 in Metacrylate PMMA

AxB mm	Art.	Finish	Variant	€ / set	set ■
13 x 11	SB 18 P11	Metacrylate	Pure White	33,23	50

Kit with 2 1,95mt bars + 2 inside corners + 1 right end cap + 1 left end cap. Loose pcs not available.

P11

The images are inserted purely for illustrative purposes

☒ For quantities below 20 pcs 10% price increase applied.



sanitec SB 30 P11



sanitec SB 18 P11



Length: 2,70 meters

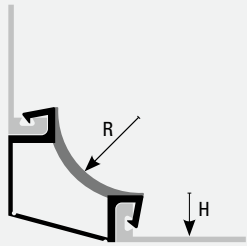

CR 16 P* + KJ - P*

R = 16 mm

Example assembled with KJ

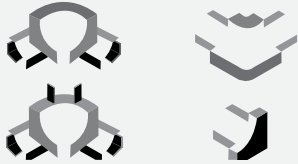

CR-P

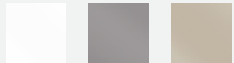

P11 P23 P32

The images are inserted purely for illustrative purposes

coflex >> CR Co-extruded Synthetic basic module

H = mm	Art.	Finish	Variant	€ / m	pc ■
16	CR 16 P11	Synthetic	Pure White	5,00	36
16	CR 16 P23	Synthetic	Cement Grey	5,00	36
16	CR 16 P32	Synthetic	Dark Beige	5,00	36

Clip system: the main module CR 16 is supplied separately from the additional modules KJ * P as they need to define the height. (tile thickness reduced by 3/32"-2mm). See table below or p. 87 of this price list.

kerajolly >> KJ in Synthetic Resin Full Body Colored Resintop

H = mm	Art.	Finish	Variant	€ / m	pc ■
6	KJ 60 P11	Synthetic Resin	Pure White	1,76	170
8	KJ 80 P11	Synthetic Resin	Pure White	1,99	160
10	KJ 100 P11	Synthetic Resin	Pure White	2,20	150
12,5	KJ 125 P11	Synthetic Resin	Pure White	2,50	130

sanitec >> CRI/CRE/CRT/CRF joints and accessories for the coflex CR

Art.	Finish	Variant	€ / set	set ■
CRI P11	Internal corner junction	Pure White	13,76	5 pcs
CRE P11	External corner junction	Pure White	13,76	5 pcs
CRT P11	Three-way junction	Pure White	13,76	5 pcs
CRF P11	End-cap	Pure White	13,76	5 pcs
CRI P23	Internal corner junction	Cement Grey	13,76	5 pcs
CRE P23	External corner junction	Cement Grey	13,76	5 pcs
CRT P23	Three-way junction	Cement Grey	13,76	5 pcs
CRF P23	End-cap	Cement Grey	13,76	5 pcs
CRI P32	Internal corner junction	Dark Beige	13,76	5 pcs
CRE P32	External corner junction	Dark Beige	13,76	5 pcs
CRT P32	Three-way junction	Dark Beige	13,76	5 pcs
CRF P32	End-cap	Dark Beige	13,76	5 pcs

Sold in 5 pcs/set.



coflex CR 16 P23 + KJ-P11

Length: 2,70 meters

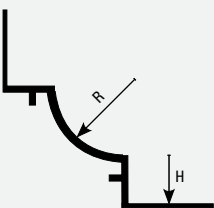

ER - P*

R = 16 mm



P11 P22

The images are inserted purely for illustrative purposes

sanitec >> ER Synthetic Resin Full Body Colored Resinil

H = mm	Art.	Finish	Variant	€ / m	pc ■
9	ER 9 P11	Synthetic Resin	Pure White	5,07	40
11	ER 11 P11	Synthetic Resin	Pure White	5,27	40
9	ER 9 P22	Synthetic Resin	Pastel Grey	5,07	40
11	ER 11 P22	Synthetic Resin	Pastel Grey	5,27	40

Sold in 5 pcs/set.

sanitec >> ERI/ERE/ERT/ERF Junctions and Accessories

Art.	Finish	€ / set	set ■
ERI P11	Internal corner junction	13,52	5 pcs
ERI P22	Internal corner junction	13,52	5 pcs

Sold in 5 pcs/set.



sanitec ER-P11 + ERI-P11

☒ For quantities below 20pcs price increase by 10%

corner edge

wall covering



Length: 2,70 meters

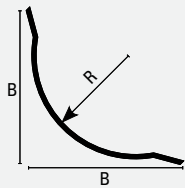

IC 25 IL
R = 16 mm

sanitec >> IC25 in stainless steel aisi 304 din 14301

B = mm	Art.		Finish	€ / m	pc ■
25 x 25	IC	25 ILN	Polished	14,71	10

Protected with a removable film. Pre-welded junction pieces.

sanitec >> ICI/ICE/ICT Junctions in Stainless Steel AISI 304 - DIN 1.4301

	Art.	Finish	Variant	€ / set	set ■
ICI	25 ILN	Polished	Internal corner junction	27,09	2 pcs
ICE	25 ILN	Polished	External corner junction	27,09	2 pcs
ICT	25 ILN	Polished	Three-way junction	27,31	2 pcs



sanitec IC 25 IL

Length: 2,70 meters

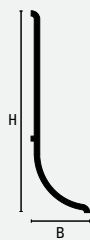

IC 60 P
B = 20 mm

sanitec >> IC60 in Fullbody Synthetic Resin Resinil

BxH mm	Art.	Finish	Variant	€ / m	pc ■
20 x 60	IC 60 P11	Synthetic Resin	Pure White	6,65	40



sanitec IC 60 P11

Length: 2,70 meters

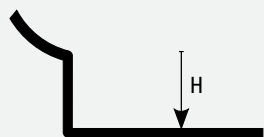

IJ - IL

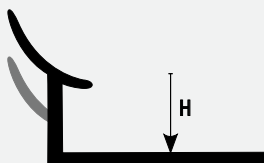

IJ - P

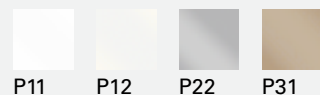

The images are inserted purely for illustrative purposes

interjolly >> IJ in Stainless Steel AISI 304 - DIN 1.4301

H = mm	Art.		Finish	€ / m	pc ■
8	IJ	80 IL	Polished	14,47	20
10	IJ	100 IL	Polished	15,18	20

Thickness 10/10 - protected with a removable film.

interjolly >> IJ in Synthetic Resin Full Body Colored Resintop

H = mm	Art.	Finish	Variant	€ / m	pc ■
7,5	IJ 75 P11	Synthetic Resin	Pure White	2,33	20
9,5	IJ 95 P11	Synthetic Resin	Pure White	2,46	20
7,5	IJ 75 P12	Synthetic Resin	Ivory White	2,33	20
9,5	IJ 95 P12	Synthetic Resin	Ivory White	2,46	20
7,5	IJ 75 P22	Synthetic Resin	Pastel Grey	2,33	20
9,5	IJ 95 P22	Synthetic Resin	Pastel Grey	2,46	20
7,5	IJ 75 P31	Synthetic Resin	Beige Bahama	2,33	20
9,5	IJ 95 P31	Synthetic Resin	Beige Bahama	2,46	20



interjolly IJ-IL



interjolly IJ-P11

⊗ For quantities below 20pcs price increase by 10%



Length: 2,00 m

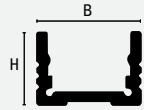

LEL 13 AS



LEB 37 AS

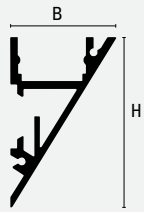

LEM 37 A11

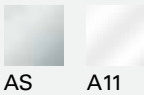

The images are inserted purely for illustrative purposes



LED profiles >> LEL/LEB in Anodized Aluminum

HxB = mm	Art.	Finish	Variant	€ / m	pc ■
13 x 18	LEL 13 AS	Anodized	Silver	15,25	1 ■
37 x 18	LEB 37 AS	Anodized	Silver	36,33	1 ■

LED profiles >> LEM in Powder Coated Aluminum

HxB = mm	Art.	Finish	Variant	€ / m	pc ■
37 x 23	LEM 37 A11	Pow. Coated	Pure White	65,33	1 ■

LED Profiles >> Light diffuser

H = mm	Art.	Finish	€ / set	set ■
15	LEC 15 OP	Opal	28,86	1 ■
15	LEC 15 TR	Trasparent	25,64	1 ■
15	LEC 15 SA	Sanded	25,64	1 ■

LED profiles >> Accessories for LEL

H = mm	Art.	Finish	€ / set	set ■
12	LELF 12	Fastener clip	5,95	2 pcs
13	LELT 13 P22	End caps (right and left)	5,54	2 pcs
60	LELC 60	Connector between two profiles	4,57	1 pc

LED profiles >> Accessories for LEB

H = mm	Art.	Finish	€ / set	set ■
15	LEBP 15 AS	Fastener clip on wall - 2 meters	14,66	1 pc
37	LEBT 37 AS	End caps (right and left)	30,21	2 pcs

LED profiles >> Accessories fo LEM

H = mm	Art.	Finish	€ / set	set ■
37	LEMT 37 A11	End caps (right and left)	39,37	2 pcs
34	LEMS	PVC mounting housing clip	5,50	2 pcs
45	LEMC	Connector between two profiles	11,90	1 pc

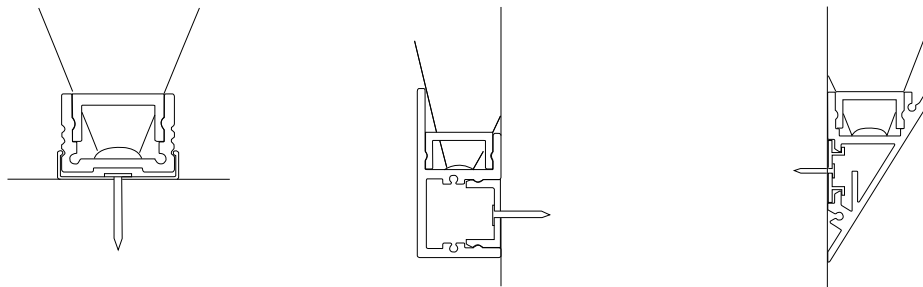

listello LEL 13 AS



wall profile LEB 37 AS



lamp LEM 37 A11

junction

wall covering





Movement joint profiles

A building's structural frame is subject to differential movement due to the contraction and expansion of construction materials and its foundation. Movement joints are vital in accommodating the building's expected settlement. Movement joint design allows the designer to control where the movement manifests within the tile layout, preventing tile cracking and tenting.

Placement of expansion movement joint profiles begin at the construction phase as all underlying expansion joints in the substrate should continue up through the tile installation. Choosing an appropriate movement joint according to a building's structural needs is fundamentally important and designers often

select them with some trepidation, worried about compromising the aesthetic qualities of the building. PROFILITEC offers technical yet elegant solutions that accentuate design features or disappear into the tile layout, Place PROFILITEC movement joints:

- In correspondence with the underlying substrate
 - In correspondence to pre-existing discontinuities in substrate such as structural construction joints.
- Screed section edges
- In correspondence with fixed elements such as columns or doors
 - In correspondence with a directional change in the tile pattern
 - In correspondence with material changes, around the perimeter of tile and stone installations and at regular bays within the stone and tile field
- The proportion between the two bay sides should generally not exceed 2:1.



Article	Code	Use	Pag.
Coflex	CE	separation profile	108
Coflex	CA	separation profile	108
Coflex	CAJ	separation profile	109
Coflex	CAJP	invisible dilatation	109
Coflex	CTL	grindable	110
Coflex	CTR	profiles	112
Coflex	CT	profiles	112
Coflex	CBR	interchangeable	113
Coflex	CB	interchangeable	113
Coflex	CBL	interchangeable	114
Coflex	CK	technical metal + Resinil	114
Coflex	CKM	dilatation deep bed	115
Coflex	CMB	technical metal + Resinil	115
Coflex	CM	modular deep bed	115
Coflex	CF	modular deep bed	116
Coflex	CD	modular deep bed	116
Coflex	CTM	grindable	116
Coflex	CR	corner joint	117
Jointec	GE	structural	118
Jointec	GEL	structural	118
Jointec	GR	structural	118
Jointec	GRL	structural	118
Jointec	GRM	structural	118
Jointec	GM	structural modular	119
Jointec	GML	structural modular	119
Jointec	GA/GAP	structural floor and wall	120
Jointec	GAL/GALP	structural floor and wall	121
Jointec	GAS	structural floor and wall	121
Jointec	GAD/GALD	structural floor and wall	121
Jointec	GADP/GALDP	structural floor and wall	121
Jointec	GH	carriageable and waterproof	122
Jointec	GS	structural high widths	122
Jointec	GEP/GELP	perimetrals	123
Jointec	GMP/GMLP	perimetrals	123
Jointec	GDP/GDLP	perimetrals	123
Jointec	GD/GDL	cover joint	124
Jointec	GDM	cover joint	124
Coprítec	CPM	cover joint	125
Jointec	GT	industrial floors	125
Coprítec	CP	cover joint	126
Jointec	GC	cement floor joints	126



Length: 2,70 meters

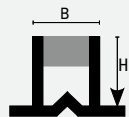

CE - P

B = 8 mm



P23

The images are inserted purely for illustrative purposes

coflex >> CE in PVC

H = mm	Art.	Finish	Variant	€ / m	pc ■
7	CE 70 P10	PVC	Trasparent	1,41	20
9	CE 90 P10	PVC	Trasparent	1,71	20
11	CE 110 P10	PVC	Trasparent	1,93	20
13	CE 130 P10	PVC	Trasparent	2,18	20
15	CE 150 P10	PVC	Trasparent	2,47	20
7	CE 70 P23	PVC	Cement Grey	1,41	20
9	CE 90 P23	PVC	Cement Grey	1,71	20
11	CE 110 P23	PVC	Cement Grey	1,93	20
13	CE 130 P23	PVC	Cement Grey	2,18	20
15	CE 150 P23	PVC	Cement Grey	2,47	20



coflex CE-P10

Length: 2,70 meters

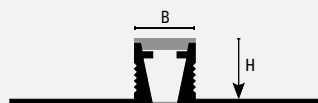

CA - P

B = 10 mm



P11 P23 P32 P51

The images are inserted purely for illustrative purposes

coflex >> CA Co-extruded Synthetic Resinil + Resinflex

H = mm	Art.	Finish	Variant	€ / m	pc ■
6	CA 60 P11	Resinil + Resinflex	Pure White	4,73	20
8	CA 80 P11	Resinil + Resinflex	Pure White	4,76	20
10	CA 100 P11	Resinil + Resinflex	Pure White	5,27	20
12,5	CA 125 P11	Resinil + Resinflex	Pure White	5,63	20
6	CA 60 P23	Resinil + Resinflex	Cement Grey	4,73	20
8	CA 80 P23	Resinil + Resinflex	Cement Grey	4,76	20
10	CA 100 P23	Resinil + Resinflex	Cement Grey	5,27	20
12,5	CA 125 P23	Resinil + Resinflex	Cement Grey	5,63	20
15	CA 150 P23	Resinil + Resinflex	Cement Grey	6,20	20
20	CA 200 P23	Resinil + Resinflex	Cement Grey	7,44	20
6	CA 60 P32	Resinil + Resinflex	Dark Beige	4,73	20
8	CA 80 P32	Resinil + Resinflex	Dark Beige	4,76	20
10	CA 100 P32	Resinil + Resinflex	Dark Beige	5,27	20
12,5	CA 125 P32	Resinil + Resinflex	Dark Beige	5,63	20
6	CA 60 P51	Resinil + Resinflex	Black	4,73	20
8	CA 80 P51	Resinil + Resinflex	Black	4,76	20
10	CA 100 P51	Resinil + Resinflex	Black	5,27	20
12,5	CA 125 P51	Resinil + Resinflex	Black	5,63	20



coflex CA-P23

✘ For quantities below 10 pcs 10% price increase applied



Length: 2,70 meters

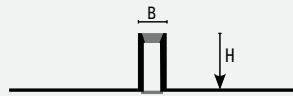

CAJ - P

B = 5 mm

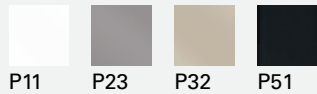

The images are inserted purely for illustrative purposes

coflex >> CAJ Co-extruded Synthetic Resinil + Resinflex

H = mm	Art.	Finish	Variant	€/ m	pc ■
4,5	CAJ 45 P11	Resinil + Resinflex	Pure White	4,42	20
6	CAJ 60 P11	Resinil + Resinflex	Pure White	4,42	20
8	CAJ 80 P11	Resinil + Resinflex	Pure White	4,46	20
10	CAJ 100 P11	Resinil + Resinflex	Pure White	4,92	20
12,5	CAJ 125 P11	Resinil + Resinflex	Pure White	5,22	20
4,5	CAJ 45 P23	Resinil + Resinflex	Cement Grey	4,42	20
6	CAJ 60 P23	Resinil + Resinflex	Cement Grey	4,42	20
8	CAJ 80 P23	Resinil + Resinflex	Cement Grey	4,46	20
10	CAJ 100 P23	Resinil + Resinflex	Cement Grey	4,92	20
12,5	CAJ 125 P23	Resinil + Resinflex	Cement Grey	5,22	20
4,5	CAJ 45 P32	Resinil + Resinflex	Dark Beige	4,42	20
6	CAJ 60 P32	Resinil + Resinflex	Dark Beige	4,42	20
8	CAJ 80 P32	Resinil + Resinflex	Dark Beige	4,46	20
10	CAJ 100 P32	Resinil + Resinflex	Dark Beige	4,92	20
12,5	CAJ 125 P32	Resinil + Resinflex	Dark Beige	5,22	20
4,5	CAJ 45 P51	Resinil + Resinflex	Black	4,42	20
6	CAJ 60 P51	Resinil + Resinflex	Black	4,42	20
8	CAJ 80 P51	Resinil + Resinflex	Black	4,46	20
10	CAJ 100 P51	Resinil + Resinflex	Black	4,92	20
12,5	CAJ 125 P51	Resinil + Resinflex	Black	5,22	20



coflex CAJ 100 P23

Length: 2,70 meters

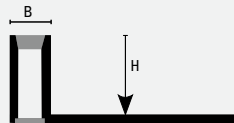

CAJP - P

B = 5 mm



P23

The images are inserted purely for illustrative purposes

coflex >> CAJP Co-extruded Synthetic Resinil + Resinflex

H = mm	Art.	Finish	Variant	€/ m	pc ■
4,5	CAJP 45 P23	Resinil + Resinflex	Cement Grey	4,42	40
6	CAJP 60 P23	Resinil + Resinflex	Cement Grey	4,42	40
8	CAJP 80 P23	Resinil + Resinflex	Cement Grey	4,46	40
10	CAJP 100 P23	Resinil + Resinflex	Cement Grey	4,92	40
12,5	CAJP 125 P23	Resinil + Resinflex	Cement Grey	5,22	40



Movement profiles

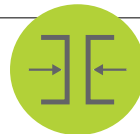

- + Allow tile movement
- + Suggested floor bays 16 m² - 172-7/32 ft² (UNI 11.499:2013)
- + Always below the decking



coflex CAJP 80 P23

☒ For quantities below 20 pcs 10% price increase applied.

invisible dilatation

joints



Length: 2,70 meters

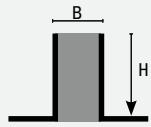

CTL

B = 10 mm



IL P23 P32 P51

The images are inserted purely for illustrative purposes

IL23= IL + P23
IL32= IL + P32
IL51= IL + P51

AN23= AN + P23
AN32= AN + P32
AN51= AN + P51

coflex >> CTL in Stainless Steel AISI 304 - DIN 1.4301 + Insert suitable for grinding EPDM

H = mm	Art.	Finish	Variant	€ / m	pc ■
8	CTL 80 IL23	Polished	Cement Grey	44,15	10
10	CTL 100 IL23	Polished	Cement Grey	45,45	10
12,5	CTL 125 IL23	Polished	Cement Grey	47,58	10
15	CTL 150 IL23	Polished	Cement Grey	50,03	10
20	CTL 200 IL23	Polished	Cement Grey	52,08	10
25	CTL 250 IL23	Polished	Cement Grey	54,70	10
30	CTL 300 IL23	Polished	Cement Grey	56,93	10
8	CTL 80 IL32	Polished	Dark Beige	44,15	10
10	CTL 100 IL32	Polished	Dark Beige	45,45	10
12,5	CTL 125 IL32	Polished	Dark Beige	47,58	10
15	CTL 150 IL32	Polished	Dark Beige	50,03	10
20	CTL 200 IL32	Polished	Dark Beige	52,08	10
25	CTL 250 IL32	Polished	Dark Beige	54,70	10
30	CTL 300 IL32	Polished	Dark Beige	56,93	10
8	CTL 80 IL51	Polished	Black	44,15	10
10	CTL 100 IL51	Polished	Black	45,45	10
12,5	CTL 125 IL51	Polished	Black	47,58	10
15	CTL 150 IL51	Polished	Black	50,03	10
20	CTL 200 IL51	Polished	Black	52,08	10
25	CTL 250 IL51	Polished	Black	54,70	10
30	CTL 300 IL51	Polished	Black	56,93	10

coflex >> CTL in Natural Aluminum + Insert suitable for grinding EPDM

H = mm	Art.	Finish	Variant	€ / m	pc ■
8	CTL 80 AN23	Natural	Cement Grey	29,46	10
10	CTL 100 AN23	Natural	Cement Grey	30,71	10
12,5	CTL 125 AN23	Natural	Cement Grey	32,50	10
15	CTL 150 AN23	Natural	Cement Grey	34,53	10
20	CTL 200 AN23	Natural	Cement Grey	35,83	10
25	CTL 250 AN23	Natural	Cement Grey	38,30	10
30	CTL 300 AN23	Natural	Cement Grey	40,52	10
8	CTL 80 AN32	Natural	Dark Beige	29,46	10
10	CTL 100 AN32	Natural	Dark Beige	30,71	10
12,5	CTL 125 AN32	Natural	Dark Beige	32,50	10
15	CTL 150 AN32	Natural	Dark Beige	34,53	10
20	CTL 200 AN32	Natural	Dark Beige	35,83	10
25	CTL 250 AN32	Natural	Dark Beige	38,30	10
30	CTL 300 AN32	Natural	Dark Beige	40,52	10
8	CTL 80 AN51	Natural	Black	29,46	10
10	CTL 100 AN51	Natural	Black	30,71	10
12,5	CTL 125 AN51	Natural	Black	32,50	10
15	CTL 150 AN51	Natural	Black	34,53	10
20	CTL 200 AN51	Natural	Black	35,83	10
25	CTL 250 AN51	Natural	Black	38,30	10
30	CTL 300 AN51	Natural	Black	40,52	10



coflex CTL AN 51



coflex CTL AN 32

✘ For quantities below 20 pcs 10% price increase applied



Length: 2,70 meters

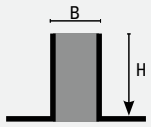

CTL

B = 10 mm



ON P23 P32 P51

The images are inserted purely for illustrative purposes

ON23= ON + P23
ON32= ON + P32
ON51= ON + P51

coflex >> CTL in Brass + Insert suitable for grinding EPDM

H = mm	Art.		Finish	Variant	€ / m	pc ■
8	CTL	80 ON23	Natural	Cement Grey	38,01	10
10	CTL	100 ON23	Natural	Cement Grey	39,97	10
12,5	CTL	125 ON23	Natural	Cement Grey	42,12	10
15	CTL	150 ON23	Natural	Cement Grey	44,74	10
20	CTL	200 ON23	Natural	Cement Grey	47,20	10
25	CTL	250 ON23	Natural	Cement Grey	50,64	10
30	CTL	300 ON23	Natural	Cement Grey	53,63	10
8	CTL	80 ON32	Natural	Dark Beige	38,01	10
10	CTL	100 ON32	Natural	Dark Beige	39,97	10
12,5	CTL	125 ON32	Natural	Dark Beige	42,12	10
15	CTL	150 ON32	Natural	Dark Beige	44,74	10
20	CTL	200 ON32	Natural	Dark Beige	47,20	10
25	CTL	250 ON32	Natural	Dark Beige	50,64	10
30	CTL	300 ON32	Natural	Dark Beige	53,63	10
8	CTL	80 ON51	Natural	Black	38,01	10
10	CTL	100 ON51	Natural	Black	39,97	10
12,5	CTL	125 ON51	Natural	Black	42,12	10
15	CTL	150 ON51	Natural	Black	44,74	10
20	CTL	200 ON51	Natural	Black	47,20	10
25	CTL	250 ON51	Natural	Black	50,64	10
30	CTL	300 ON51	Natural	Black	53,63	10

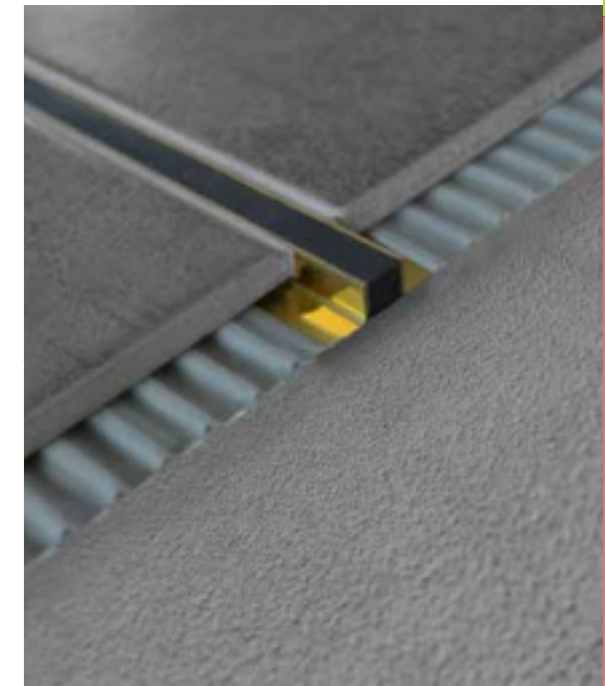

coflex CTL ON 51

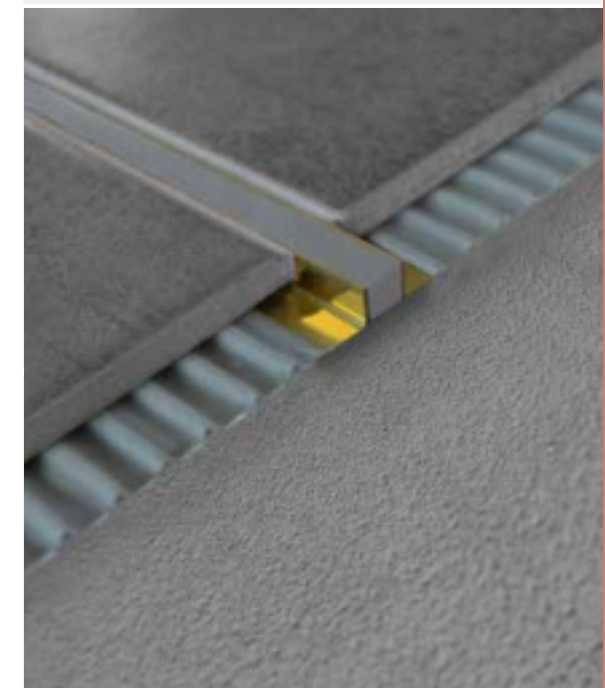

coflex CTL ON 23

grindable

joints

☒ For quantities below 10 pcs 10% price increase applied



Length: 2,70 meters

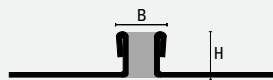

CTR

B = 10 mm



IL P23 P51

The images are inserted purely for illustrative purposes

IL23= IL + P23

IL51= IL + P51

coflex >> CTR in Stainless Steel AISI 304 - DIN. 1.4301 - Polished + Insert EPDM

H = mm	Art.	Finish	Variant	€ / m	pc ■
3	CTR 30 IL23	Polished	Cement Grey	28,73	10
4,5	CTR 45 IL23	Polished	Cement Grey	29,16	10
6	CTR 60 IL23	Polished	Cement Grey	29,61	10
8	CTR 80 IL23	Polished	Cement Grey	30,21	10
10	CTR 100 IL23	Polished	Cement Grey	31,25	10
12,5	CTR 125 IL23	Polished	Cement Grey	32,36	10
15	CTR 150 IL23	Polished	Cement Grey	37,87	10
20	CTR 200 IL23	Polished	Cement Grey	42,47	10
3	CTR 30 IL51	Polished	Black	28,73	10
4,5	CTR 45 IL51	Polished	Black	29,16	10
6	CTR 60 IL51	Polished	Black	29,61	10
8	CTR 80 IL51	Polished	Black	30,21	10
10	CTR 100 IL51	Polished	Black	31,25	10
12,5	CTR 125 IL51	Polished	Black	32,36	10
15	CTR 150 IL51	Polished	Black	37,87	10
20	CTR 200 IL51	Polished	Black	42,47	10



coflex CTR IL 23

Length: 2,70 meters

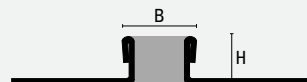

CT

B = 15 mm

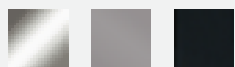

IL P23 P51

The images are inserted purely for illustrative purposes

IL23= IL + P23

IL51= IL + P51

coflex >> CT in Stainless Steel AISI 304 - DIN. 1.4301 - Polished + Insert EPDM

H = mm	Art.	Finish	Variant	€ / m	pc ■
8	CT 80 IL23	Polished	Cement Grey	34,68	10
10	CT 100 IL23	Polished	Cement Grey	35,88	10
12,5	CT 125 IL23	Polished	Cement Grey	37,15	10
15	CT 150 IL23	Polished	Cement Grey	43,48	10
20	CT 200 IL23	Polished	Cement Grey	48,76	10
8	CT 80 IL51	Polished	Black	34,68	10
10	CT 100 IL51	Polished	Black	35,88	10
12,5	CT 125 IL51	Polished	Black	37,15	10
15	CT 150 IL51	Polished	Black	43,48	10
20	CT 200 IL51	Polished	Black	48,76	10



coflex CT IL 23

⊗ For quantities below 10 pcs 10% price increase applied.



Length: 2,70 meters

Insert assembled.

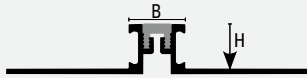

CBR

B = 10 mm



CBRI



AN P23 P51

The images are inserted purely for illustrative purposes

coflex >> CBR in Natural Aluminum + Synthetic Insert

H = mm	Art.	Finish	Variant	€/m	pc
4,5	CBR 45 AN23	Natural	Cement Grey	11,82	10
6	CBR 60 AN23	Natural	Cement Grey	12,00	10
8	CBR 80 AN23	Natural	Cement Grey	12,24	10
10	CBR 100 AN23	Natural	Cement Grey	12,46	10
12,5	CBR 125 AN23	Natural	Cement Grey	12,79	10
15	CBR 150 AN23	Natural	Cement Grey	13,57	10
20	CBR 200 AN23	Natural	Cement Grey	14,70	10
4,5	CBR 45 AN51	Natural	Black	11,82	10
6	CBR 60 AN51	Natural	Black	12,00	10
8	CBR 80 AN51	Natural	Black	12,24	10
10	CBR 100 AN51	Natural	Black	12,46	10
12,5	CBR 125 AN51	Natural	Black	12,79	10
15	CBR 150 AN51	Natural	Black	13,57	10
20	CBR 200 AN51	Natural	Black	14,70	10

coflex >> CBRI Spare insert Resinflex

H = mm	Art.	Finish	Variant	€/m	pc
5	CBRI 5 P23	Resinflex	Cement Grey	1,71	10
5	CBRI 5 P51	Resinflex	Black	1,71	10



coflex CBR AN 23

Length: 2,70 meters

Insert assembled.

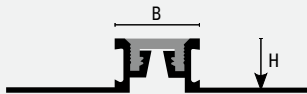

CB

B = 16 mm

Replaceable insert. See next page.



AN ON P23 P51

The images are inserted purely for illustrative purposes

coflex >> CB in Natural Aluminum + Synthetic Insert Resinflex

H = mm	Art.	Finish	Variant	€/m	pc
8	CB 80 AN23	Natural	Cement Grey	14,02	10
10	CB 100 AN23	Natural	Cement Grey	14,29	10
12,5	CB 125 AN23	Natural	Cement Grey	14,73	10
15	CB 150 AN23	Natural	Cement Grey	15,62	10
20	CB 200 AN23	Natural	Cement Grey	17,12	10
8	CB 80 AN51	Natural	Black	14,02	10
10	CB 100 AN51	Natural	Black	14,29	10
12,5	CB 125 AN51	Natural	Black	14,73	10
15	CB 150 AN51	Natural	Black	15,62	10
20	CB 200 AN51	Natural	Black	17,12	10

Supplied completely assembled.



coflex CB AN 23

coflex >> CB in Natural Brass + Synthetic Insert Resinflex

H = mm	Art.	Finish	Variant	€/m	pc
8	CB 80 ON23	Natural	Cement Grey	32,04	10
10	CB 100 ON23	Natural	Cement Grey	33,57	10
12,5	CB 125 ON23	Natural	Cement Grey	35,43	10
15	CB 150 ON23	Natural	Cement Grey	37,30	10
20	CB 200 ON23	Natural	Cement Grey	41,26	10
8	CB 80 ON51	Natural	Black	32,04	10
10	CB 100 ON51	Natural	Black	33,57	10
12,5	CB 125 ON51	Natural	Black	35,43	10
15	CB 150 ON51	Natural	Black	37,30	10
20	CB 200 ON51	Natural	Black	41,26	10

Supplied completely assembled.



coflex CB AN 51

☒ For quantities below 10 pcs 10% price increase applied.

interchangeable

joints

Length: 2,70 meters

Insert assembled.

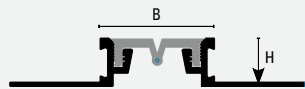

CBL

B = 26 mm



AN ON P23 P51

The images are inserted purely for illustrative purposes

AN23= AN + P23
AN51= AN + P51
ON23= ON + P23
ON51= ON + P51

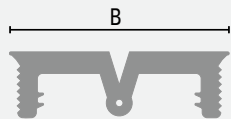

CBI 20 P*

coflex >> CBL in Natural Aluminum + Synthetic Insert Resinflex

H = mm	Art.		Finish	Variant	€ / m	pc ■
8	CBL	80 AN23	Natural	Cement Grey	16,15	10
10	CBL	100 AN23	Natural	Cement Grey	16,49	10
12,5	CBL	125 AN23	Natural	Cement Grey	17,00	10
15	CBL	150 AN23	Natural	Cement Grey	18,06	10
20	CBL	200 AN23	Natural	Cement Grey	19,77	10
8	CBL	80 AN51	Natural	Black	16,15	10
10	CBL	100 AN51	Natural	Black	16,49	10
12,5	CBL	125 AN51	Natural	Black	17,00	10
15	CBL	150 AN51	Natural	Black	18,06	10
20	CBL	200 AN51	Natural	Black	19,77	10

Supplied completely assembled.

coflex >> CBL in Natural Brass + Synthetic Insert Resinflex

H = mm	Art.		Finish	Variant	€ / m	pc ■
8	CBL	80 ON23	Natural	Cement Grey	33,97	10
10	CBL	100 ON23	Natural	Cement Grey	35,58	10
12,5	CBL	125 ON23	Natural	Cement Grey	37,57	10
15	CBL	150 ON23	Natural	Cement Grey	39,52	10
20	CBL	200 ON23	Natural	Cement Grey	43,74	10
8	CBL	80 ON51	Natural	Black	33,97	10
10	CBL	100 ON51	Natural	Black	35,58	10
12,5	CBL	125 ON51	Natural	Black	37,57	10
15	CBL	150 ON51	Natural	Black	39,52	10
20	CBL	200 ON51	Natural	Black	43,74	10

Supplied completely assembled.

coflex >> CBI Spare insert Resinflex

B = mm	Art.		Finish	Variant	€ / m	pc ■
10	CBI	10 P23	Resinflex	Cement Grey	4,25	10
20	CBI	20 P23	Resinflex	Cement Grey	5,12	10
10	CBI	10 P51	Resinflex	Black	4,25	10
20	CBI	20 P51	Resinflex	Black	5,12	10

☒ For quantities below 10 pcs 10% price increase applied.



coflex CBL AN 51



coflex CBL ON 51



coflex CK-AN



coflex CK-ON

Length: 2,70 meters

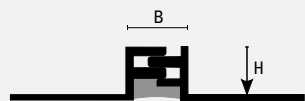

CK

B = 11 mm



AN ON

The images are inserted purely for illustrative purposes

coflex >> CK in Natural Aluminum

H = mm	Art.		Finish	€ / m	pc ■
10	CK	100 AN	Natural	15,53	10
12,5	CK	125 AN	Natural	16,11	10

Supplied completely assembled.

coflex >> CK in Brass

H = mm	Art.		Finish	€ / m	pc ■
10	CK	100 ON	Natural	34,92	10
12,5	CK	125 ON	Natural	36,93	10

Supplied completely assembled.

☒ For quantities below 10 pcs 10% price increase applied.



Length: 2,70 meters



CKM



AN ON

coflex >> CKM in Natural Aluminum

HxB mm	Art.	Finish	€/m	pc ■
45 x 11	CKM 450 AN	Natural	16,07	10

Profile not assembled. Assemble rubber-foam just before the installation.

coflex >> CKM in Brass

HxB mm	Art.	Finish	€/m	pc ■
45 x 11	CKM 450 ON	Natural	45,08	10

Profile not assembled. Assemble rubber-foam just before the installation.



coflex CKM 450 AN



coflex CKM ON

Length: 2,70 meters

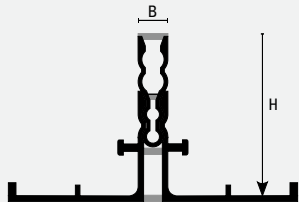

CMB - P
B = 8 mm



P23

The images are inserted purely for illustrative purposes

coflex >> CMB Co-extruded Synthetic Resinil + Resinflex

H = mm	Art.	Finish	Variant	€/m	pc ■
30	CMB 300 P23	Resinil + Resinflex	Cement Grey	7,26	15
45	CMB 450 P23	Resinil + Resinflex	Cement Grey	9,84	15
60	CMB 600 P23	Resinil + Resinflex	Cement Grey	12,32	15
30	CMB 300 P	Resinil + Resinflex	Cement Grey	6,14	15

CMB is a modular expansion joint; further heights can be achieved using the modules Art. CM which has to be ordered separately.



coflex CMB-P23

Length: 2,70 meters

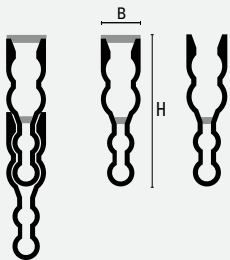

CM - P

B = 8 mm

coflex >> CM Co-extruded Synthetic Resinil + Resinflex

H = mm	Art.	Finish	Variant	€/m	pc ■
30	CM 300 P23	Resinil + Resinflex	Cement Grey	3,70	50
30	CM 300 P51	Resinil + Resinflex	Black	3,70	50
30	CM 300 P61	Resinil + Resinflex	Red Klinker	3,70	50
15-20	CM 200 P	Extension		2,49	50



coflex CM-P23

☒ For quantities below 10 pcs 10% price increase applied



Length: 2,70 meters

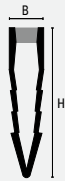

CF - P



P23

coflex >> CF in PVC

HxB mm	Art.	Finish	Variant	€ / m	pc ■
23 x 8	CF 230 P10	PVC	Trasparent	2,12	20
35 x 8	CF 350 P10	PVC	Trasparent	2,83	20
45 x 8	CF 450 P10	PVC	Trasparent	3,39	20
23 x 8	CF 230 P23	PVC	Cement Grey	2,12	20
35 x 8	CF 350 P23	PVC	Cement Grey	2,83	20
45 x 8	CF 450 P23	PVC	Cement Grey	3,39	20



coflex CF-P23

Length: 2,70 meters

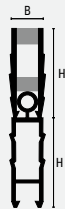

CD - P

coflex >> CD in PVC

HxB mm	Art.	Finish	Variant	€ / m	pc ■
23 x 8	CD 230 P10	PVC	Grey + Trasparent	2,75	50
23 x 8	CD 230 P23	PVC	Grey + Cement Grey	2,75	50
22 x 8	CD 220 P		Extension	1,76	50



coflex CD-P10

Length: 2,70 meters



CTM 440



IL

ON

P23

P32



P51

The images are inserted purely for illustrative purposes

coflex >> CTM in Stainless Steel AISI 304 - DIN 1.4301 + EPDM

HxB mm	Art.	Finish	Variant	€ / m	pc ■
44 x 10	CTM 440 IL23	Polished	Cement Grey	58,00	10
44 x 10	CTM 440 IL32	Polished	Beige	58,00	10
44 x 10	CTM 440 IL51	Polished	Black	58,00	10

coflex >> CTM in Brass + EPDM

HxB mm	Art.	Finish	Variant	€ / m	pc ■
44 x 10	CTM 440 ON23	Natural	Cement Grey	54,82	10
44 x 10	CTM 440 ON32	Natural	Beige	54,82	10
44 x 10	CTM 440 ON51	Natural	Black	54,82	10



coflex CTM 440 ON51

✘ For quantities below 10 pcs 10% price increase applied



Length: 2,70 meters

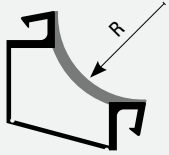

CR 16 P
R = 16 mm

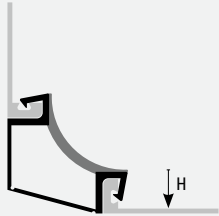

Example assembled with KJ



CR-P

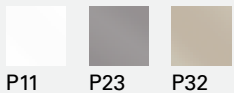

The images are inserted purely for illustrative purposes

coflex >> CR Co-extruded Synthetic basic module

R = mm	CR	Art.	Finish	Variant	€ / m	pc ■
16	CR 16	P11	Synthetic	Pure White	5,00	36
16	CR 16	P23	Synthetic	Cement Grey	5,00	36
16	CR 16	P32	Synthetic	Dark Beige	5,00	36

Clip system: additional modules art KJ-P to be ordered separately from the base module CR16 according to the required height (tile thickness reduced of 2 mm). See table below.

coflex >> KJModule to be combined to the coflex CR16P*

H = mm	KJ	Art.	Finish	Variant	€ / m	pc ■
6	KJ 60	P11	Synthetic Resin	Pure White	1,76	170
8	KJ 80	P11	Synthetic Resin	Pure White	1,99	160
10	KJ 100	P11	Synthetic Resin	Pure White	2,20	150
12,5	KJ 125	P11	Synthetic Resin	Pure White	2,50	130

coflex >> CRI Jointing and internal corner pieces for CR

Art.	Finish	Variant	€ / set	set ■
CRI P11	Internal corner junction	Pure White	13,76	5 pcs
CRI P23	Internal corner junction	Cement Grey	13,76	5 pcs
CRI P32	Internal corner junction	Dark Beige	13,76	5 pcs

Loose pcs not available.

coflex >> CRE Jointing and External corner pieces for CR

Art.	Finish	Variant	€ / set	set ■
CRE P11	External corner junction	Pure White	13,76	5 pcs
CRE P23	External corner junction	Cement Grey	13,76	5 pcs
CRE P32	External corner junction	Dark Beige	13,76	5 pcs

Loose pcs not available.

coflex >> CRT Three-way junction for CR

Art.	Finish	Variant	€ / set	set ■
CRT P11	Three-way junction	Pure White	13,76	5 pcs
CRT P23	Three-way junction	Cement Grey	13,76	5 pcs
CRT P32	Three-way junction	Dark Beige	13,76	5 pcs

Loose pcs not available.

coflex >> CRF End caps for CR

Art.	Finish	Variant	€ / set	set ■
CRF P11	End-cap	Pure White	13,76	5 pcs
CRF P23	End-cap	Cement Grey	13,76	5 pcs
CRF P32	End-cap	Dark Beige	13,76	5 pcs

Loose pcs not available.



Co-extruded joint



- + Can be used with KJ
- + Reduced stock
- + Flexibility with different thicknesses



coflex CR 16 P23 + KJ-P11



coflex CR 16 P11 + KJ-P11

modular deep bed

joints

☒ For quantities below 20 pcs 10% price increase applied.

Length: 4,00 meters

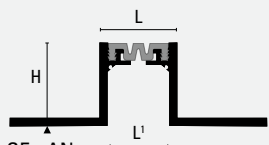

GE - AN
GEL - AN

GE:

L = 44 mm

L1 = 38 mm

GEL:

L = 54 mm

L1 = 48 mm

jointec >> GE in Aluminum + Insert Resinprene

H = mm	Art.		Finish	Variant	€ / m	pc ■
20	GE	200 AN23	Natural + Resinprene	Cement Grey	56,61	10
50	GE	500 AN23	Natural + Resinprene	Cement Grey	79,96	10
20	GE	200 AN51	Natural + Resinprene	Black (recommended)	56,61	10
50	GE	500 AN51	Natural + Resinprene	Black (recommended)	79,96	10

Profile not assembled with the rubber insert.

jointec >> GEL in Aluminum + Insert Resinprene

H = mm	Art.		Finish	Variant	€ / m	pc ■
20	GEL	200 AN23	Natural + Resinprene	Cement Grey	59,35	10
50	GEL	500 AN23	Natural + Resinprene	Cement Grey	82,70	10
20	GEL	200 AN51	Natural + Resinprene	Black (recommended)	59,35	10
50	GEL	500 AN51	Natural + Resinprene	Black (recommended)	82,70	10

Profile not assembled with the rubber insert.

Length: 4,00 meters

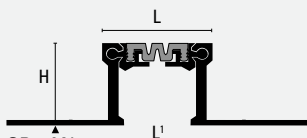

GR - AN
GRL - AN

GR:

L = 68 mm

L1 = 46 mm

GRL:

L = 78 mm

L1 = 56 mm

AN23= AN + P23

AN51= AN + P51

jointec >> GR in Aluminum + Insert Resinprene

H = mm	Art.		Finish	Variant	€ / m	pc ■
20	GR	200 AN23	Natural + Resinprene	Cement Grey	99,06	10
50	GR	500 AN23	Natural + Resinprene	Cement Grey	120,26	10
70	GR	700 AN23	Natural + Resinprene	Cement Grey	136,71	10
20	GR	200 AN51	Natural + Resinprene	Black (recommended)	99,06	10
50	GR	500 AN51	Natural + Resinprene	Black (recommended)	120,26	10
70	GR	700 AN51	Natural + Resinprene	Black (recommended)	136,71	10

Profile not assembled with the rubber insert.

jointec >> GRL in Aluminum + Insert Resinprene

H = mm	Art.		Finish	Variant	€ / m	pc ■
20	GRL	200 AN23	Natural + Resinprene	Cement Grey	101,80	10
50	GRL	500 AN23	Natural + Resinprene	Cement Grey	123,02	10
70	GRL	700 AN23	Natural + Resinprene	Cement Grey	139,44	10
20	GRL	200 AN51	Natural + Resinprene	Black (recommended)	101,80	10
50	GRL	500 AN51	Natural + Resinprene	Black (recommended)	123,02	10
70	GRL	700 AN51	Natural + Resinprene	Black (recommended)	139,44	10

Profile not assembled with the rubber insert.

Length: 4,00 meters

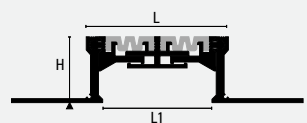

GRM - AN

L = 105 mm

L1 = 90 mm

jointec >> GRM Aluminum + Insert Resinprene

H = mm	Art.		Finish	Variant	€ / m	pc ■
50	GRM	500 AN23	Natural + Resinprene	Cement Grey	198,28	10
70	GRM	700 AN23	Natural + Resinprene	Cement Grey	217,61	10
50	GRM	500 AN51	Natural + Resinprene	Black (recommended)	198,28	10
70	GRM	700 AN51	Natural + Resinprene	Black (recommended)	217,61	10

Profile not assembled with the rubber insert.



jointec GE-AN23



jointec GRL-AN51

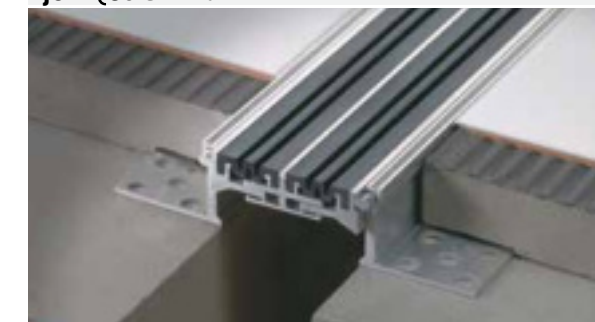

jointec GRM-AN51

✘ For quantities below 10 pcs 10% price increase applied

Length IL: 2,70 m

Length AN: 3,00 m

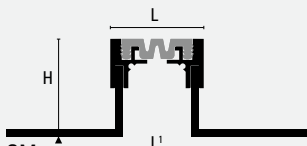

GM
GML

GM:

L = 50 mm

L1 = 38 mm

GML:

L = 60 mm

L1 = 48 mm

GM and GML series can be used with all mortar bed heights. Minimum qty: 45m.



IL AN P23 P51

The images are inserted purely for illustrative purposes

IL23= IL + P23

IL51= IL + P51

AN23= AN + P23

AN51= AN + P51

jointec >> GM in Stainless Steel AISI 304 + Base Aluminum + Insert Resinprene

H = mm	Art.	Finish	Variant	€ / m	pc ■
35	GM 350 IL23	Polished + Resinprene	Cement Grey	186,70	10
50	GM 500 IL23	Polished + Resinprene	Cement Grey	198,78	10
75	GM 750 IL23	Polished + Resinprene	Cement Grey	210,87	10
35	GM 350 IL51	Polished + Resinprene	Black (recommended)	186,70	10
50	GM 500 IL51	Polished + Resinprene	Black (recommended)	198,78	10
75	GM 750 IL51	Polished + Resinprene	Black (recommended)	210,87	10

Profile not assembled with the rubber insert.

jointec >> GML in Stainless Steel AISI 304 + Base Aluminum + Insert Resinprene

H = mm	Art.	Finish	Variant	€ / m	pc ■
35	GML 350 IL23	Polished + Resinprene	Cement Grey	189,58	10
50	GML 500 IL23	Polished + Resinprene	Cement Grey	201,65	10
75	GML 750 IL23	Polished + Resinprene	Cement Grey	213,12	10
35	GML 350 IL51	Polished + Resinprene	Black (recommended)	189,58	10
50	GML 500 IL51	Polished + Resinprene	Black (recommended)	201,65	10
75	GML 750 IL51	Polished + Resinprene	Black (recommended)	213,12	10

Profile in part assembled.

jointec >> GM in Natural Aluminum + Insert Resinprene

H = mm	Art.	Finish	Variant	€ / m	pc ■
35	GM 350 AN23	Natural + Resinprene	Cement Grey	133,50	10
50	GM 500 AN23	Natural + Resinprene	Cement Grey	146,83	10
75	GM 750 AN23	Natural + Resinprene	Cement Grey	157,28	10
35	GM 350 AN51	Natural + Resinprene	Black (recommended)	133,50	10
50	GM 500 AN51	Natural + Resinprene	Black (recommended)	146,83	10
75	GM 750 AN51	Natural + Resinprene	Black (recommended)	157,28	10

Profile not assembled with the rubber insert.

jointec >> GML in Natural Aluminum + Insert Resinprene

H = mm	Art.	Finish	Variant	€ / m	pc ■
35	GML 350 AN23	Natural + Resinprene	Cement Grey	136,09	10
50	GML 500 AN23	Natural + Resinprene	Cement Grey	149,59	10
75	GML 750 AN23	Natural + Resinprene	Cement Grey	160,04	10
35	GML 350 AN51	Natural + Resinprene	Black (recommended)	136,09	10
50	GML 500 AN51	Natural + Resinprene	Black (recommended)	149,59	10
75	GML 750 AN51	Natural + Resinprene	Black (recommended)	160,04	10

Profile not assembled with the rubber insert.



jointec GM - IL

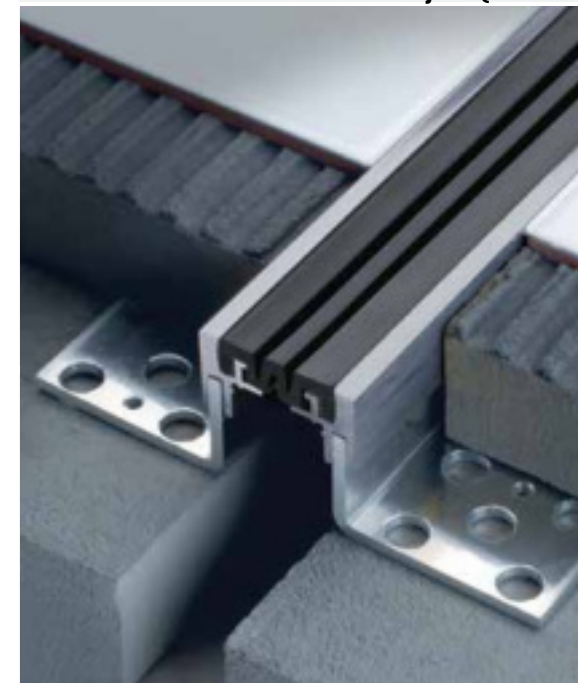

structural

joints

☒ For quantities below 10 pcs 10% price increase applied



Length: 3,00 meters

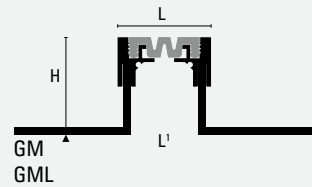

GM:
L = 50 mm
L1 = 38 mm
GML:
L = 60 mm
L1 = 48 mm
GM and GML series can be used with all mortar bed heights. Minimum qty: 45m.

jointec >> GM in Brass + Base Aluminum + Insert Resinprene

H = mm	Art.	Finish	Variant	€ / m	pc ■
35	GM 350 ON23	Natural + Resinprene	Cement Grey	191,71	10
50	GM 500 ON23	Natural + Resinprene	Cement Grey	204,12	10
75	GM 750 ON23	Natural + Resinprene	Cement Grey	216,54	10
35	GM 350 ON51	Natural + Resinprene	Black (recommended)	191,71	10
50	GM 500 ON51	Natural + Resinprene	Black (recommended)	204,12	10
75	GM 750 ON51	Natural + Resinprene	Black (recommended)	216,54	10

Profile not assembled with the rubber insert.

jointec >> GML in Brass + Base Aluminum + Insert Resinprene

H = mm	Art.	Finish	Variant	€ / m	pc ■
35	GML 350 ON23	Natural + Resinprene	Cement Grey	194,67	10
50	GML 500 ON23	Natural + Resinprene	Cement Grey	207,08	10
75	GML 750 ON23	Natural + Resinprene	Cement Grey	218,86	10
35	GML 350 ON51	Natural + Resinprene	Black (recommended)	194,67	10
50	GML 500 ON51	Natural + Resinprene	Black (recommended)	207,08	10
75	GML 750 ON51	Natural + Resinprene	Black (recommended)	218,86	10

Profile not assembled with the rubber insert.

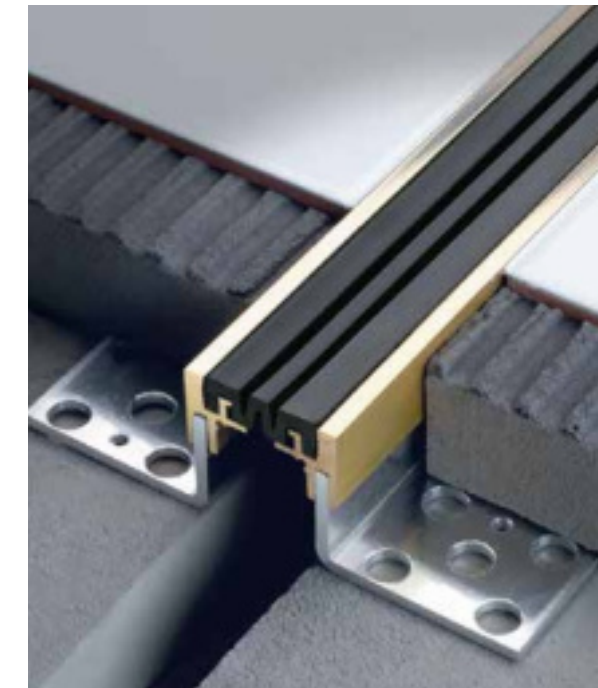

jointec GM - ON

Roll length 40 meters

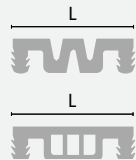

GI-P/GIL370P

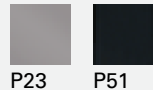

The images are inserted purely for illustrative purposes

jointec >> GI Insert in Resinprene standard

L = mm	Art.	Finish	Variant	€ / m	roll ■
37	GI 370 P23	Resinprene	Cement Grey	9,70	1
47	GI 470 P23	Resinprene	Cement Grey	12,49	1
37	GI 370 P51	Resinprene	Black	9,70	1
47	GI 470 P51	Resinprene	Black	12,49	1

jointec >> GIL Insert in Resinprene with smooth surface

L = mm	Art.	Finish	Variant	€ / m	roll ■
37	GIL 370 P23	Resinprene	Cement Grey	9,70	1
37	GIL 370 P51	Resinprene	Black	9,70	1

The joints are supplied unassembled from the rubber insert: GI370 or GI470 as order.
To order the insert with the smooth surface add the letter S after the article code. Ex: GE500AN51S.



jointec GAP - AN

Length: 4,00 meters

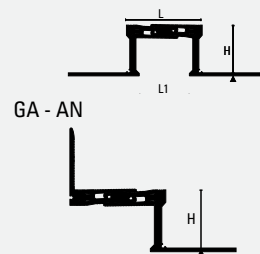

GAP - AN
GA / GAP
L = 74 mm
L1 = 54 mm

jointec >> GA in Natural Aluminum

H = mm	Art.	Finish	€ / m	pc ■
20	GA 200 AN	Natural	130,92	10
50	GA 500 AN	Natural	154,62	10
70	GA 700 AN	Natural	175,70	10

jointec >> GAP Perimetral in Aluminum

H = mm	Art.	Finish	€ / m	pc ■
20	GAP 200 AN	Natural	130,92	10
50	GAP 500 AN	Natural	154,62	10
70	GAP 700 AN	Natural	175,70	10

The wall flange can be positioned both upwards as a baseboard and downwards.

☒ For quantities below 10 pcs 10% price increase applied.



Length: 4,00 meters

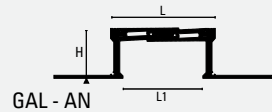

GAL - AN

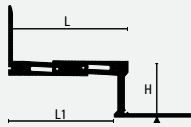

GALP - AN
GAL / GALP:
L = 105 mm
L1 = 86 mm

jointec >> GAL in Natural Aluminum

H = mm	Art.		Finish	€ / m	pc ■
20	GAL	200 AN	Natural	155,60	10
50	GAL	500 AN	Natural	178,75	10
70	GAL	700 AN	Natural	198,20	10

jointec >> GALP Perimetral in Aluminum

H = mm	Art.		Finish	€ / m	pc ■
20	GALP	200 AN	Natural	155,60	10
50	GALP	500 AN	Natural	178,75	10
70	GALP	700 AN	Natural	198,20	10

The wall flange can be positioned both upwards as a baseboard and downwards.

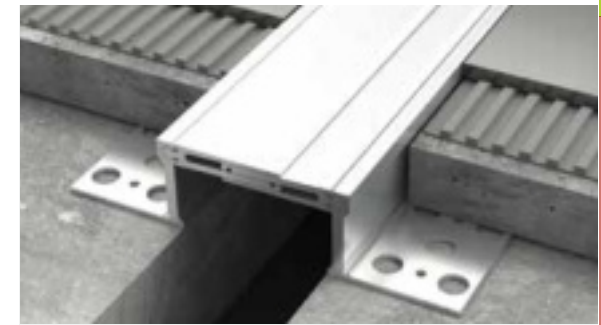

jointec GAL - AN

Length: 2,70 meters

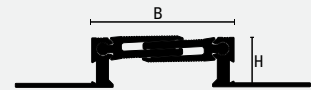

GAS - A

B variable = from 33 mm a 40 mm



AN AS

The images are inserted purely for illustrative purposes

jointec >> GAS in Natural Aluminum

H = mm	Art.		Finish	€ / m	pc ■
10	GAS	100 AN	Natural	34,43	10
12,5	GAS	125 AN	Natural	36,26	10
15	GAS	150 AN	Natural	38,09	10
20	GAS	200 AN	Natural	41,75	10

jointec >> GAS in Anodized Aluminum

H = mm	Art.		Finish	Variant	€ / m	pc ■
10	GAS	100 AS	Anodized	Silver	44,95	10
12,5	GAS	125 AS	Anodized	Silver	47,24	10
15	GAS	150 AS	Anodized	Silver	49,52	10
20	GAS	200 AS	Anodized	Silver	53,65	10

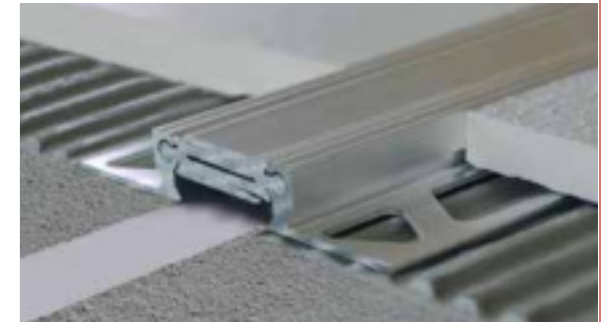

jointec GAS - AN

Length: 4,00 meters

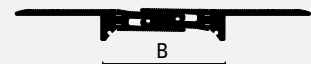

GAD - AN
GALD - AN

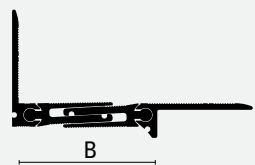

GADP - AN
GALDP - AN

jointec >> GAD e GALD Perimetral cover in Aluminum - above floor

B = mm	Art.		Finish	€ / m	pc ■
75	GAD	700 AN	Natural	102,25	10
105	GALD	1000 AN	Natural	124,71	10

jointec >> GADP e GALDP Perimetral cover in Aluminum - above floor and on wall

B = mm	Art.		Finish	€ / m	pc ■
78	GADP	700 AN	Natural	102,25	10
110	GALDP	1000 AN	Natural	124,71	10

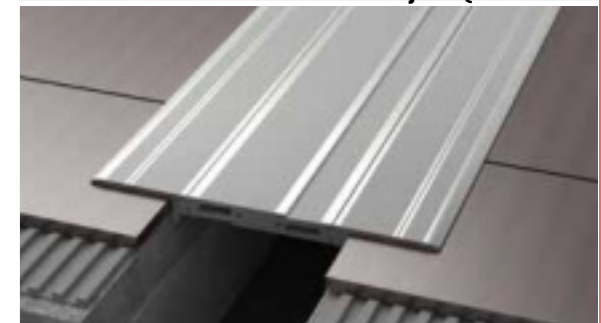

jointec GAD - AN

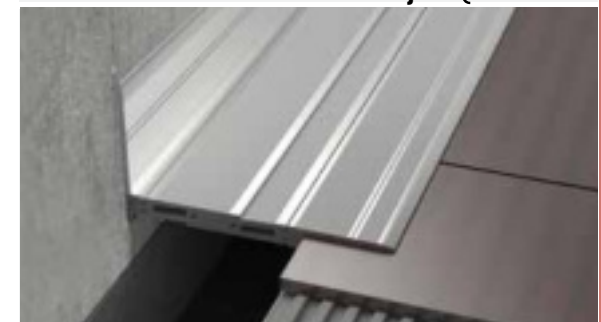

jointec GADP - AN

For quantities below 10 pcs 10% price increase applied
 Individually wrapped



Length: 3,00 meters



GH - AN
H = 20 mm



AN

The images are inserted purely for illustrative purposes

jointec >> GH in Aluminum

	L/L1 mm	Art.		Finish	€ / m	pc ■
	100 / 305	GH	1000 AN	Natural	on demand	10
	150 / 360	GH	1500 AN	Natural	on demand	10
	200 / 410	GH	2000 AN	Natural	on demand	10

Profile supplied assembled. Supplied with mountings holes and countersunk bolts at 15cm intervals.



jointec GH - AN

Length: 4,00 meters

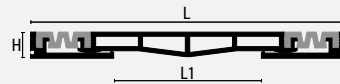

GS - AN
L = 210 mm
L1 = 100 mm

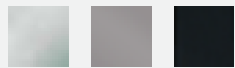

AN P23 P51

The images are inserted purely for illustrative purposes

jointec >> GS in Aluminum + Insert

H = mm	Art.		Finish	Variant	€ / m	pc ■
18	GS	1000 AN23	Natural + Resinprene	Cement Grey	190,96	10
18	GS	1000 AN51	Natural + Resinprene	Black (recommended)	190,96	10

Profile not assembled with the rubber insert. Thickness 18cm



GS seismic joint

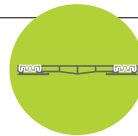

- + High horizontal absorption +/- 12mm
- + Vehicle Accessible
- + Double insert



jointec GS - AN

☒ For quantities below 10 pcs 10% price increase applied.

Length: 4,00 meters



GEP - AN
GELP - A

GEP:
L1 = 40 mm
GELP:
L1 = 50 mm

jointec >> GEP Perimetral in Aluminum

H = mm	Art.	Finish	Variant	€ / m	pc ■
20	GEP 200 AN23	Aluminum + Resinprene	Cement Grey	56,61	10
50	GEP 500 AN23	Aluminum + Resinprene	Cement Grey	79,96	10
20	GEP 200 AN51	Aluminum + Resinprene	Black (recommended)	56,61	10
50	GEP 500 AN51	Aluminum + Resinprene	Black (recommended)	79,96	10

Profile not assembled with the rubber insert

jointec >> GELP Perimetral in Aluminum

H = mm	Art.	Finish	Variant	€ / m	pc ■
20	GELP 200 A23	Aluminum + Resinprene	Cement Grey	59,39	10
50	GELP 500 A23	Aluminum + Resinprene	Cement Grey	82,73	10
20	GELP 200 A51	Aluminum + Resinprene	Black (recommended)	59,39	10
50	GELP 500 A51	Aluminum + Resinprene	Black (recommended)	82,73	10

Profile not assembled with the rubber insert

Length: 3,00 meters

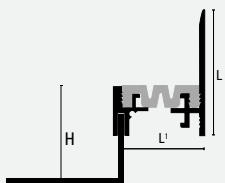

GMP - AN
GMLP - A

GMP:
L1 = 40 mm
GMLP:
L1 = 50 mm

jointec >> GMP Perimetral in Aluminum

H = mm	Art.	Finish	Variant	€ / m	pc ■
35	GMP 350 AN23	Aluminum + Resinprene	Cement Grey	133,50	10
50	GMP 500 AN23	Aluminum + Resinprene	Cement Grey	146,83	10
75	GMP 750 AN23	Aluminum + Resinprene	Cement Grey	157,28	10
35	GMP 350 AN51	Aluminum + Resinprene	Black (recommended)	133,50	10
50	GMP 500 AN51	Aluminum + Resinprene	Black (recommended)	146,83	10
75	GMP 750 AN51	Aluminum + Resinprene	Black (recommended)	157,28	10

Profile not assembled with the rubber insert

jointec >> GMLP Perimetral in Aluminum

H = mm	Art.	Finish	Variant	€ / m	pc ■
35	GMLP 350 A23	Aluminum + Resinprene	Cement Grey	136,24	10
50	GMLP 500 A23	Aluminum + Resinprene	Cement Grey	149,59	10
75	GMLP 750 A23	Aluminum + Resinprene	Cement Grey	159,53	10
35	GMLP 350 A51	Aluminum + Resinprene	Black (recommended)	136,24	10
50	GMLP 500 A51	Aluminum + Resinprene	Black (recommended)	149,59	10
75	GMLP 750 A51	Aluminum + Resinprene	Black (recommended)	159,53	10

Profile not assembled with the rubber insert

Length: 4,00 meters

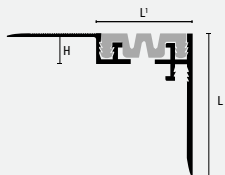

GDP - AN
GDLP - A

GDP:
L1 = 43 mm
GDLP:
L1 = 53 mm

jointec >> GDP Perimetral in Aluminum

H = mm	Art.	Finish	Variant	€ / m	pc ■
12	GDP 400 AN23	Aluminum + Resinprene	Cement Grey	36,79	10
12	GDP 400 AN51	Aluminum + Resinprene	Black (recommended)	36,79	10

jointec >> GDLP Perimetral in Aluminum

H = mm	Art.	Finish	Variant	€ / m	pc ■
12	GDLP 500 A23	Aluminum + Resinprene	Cement Grey	39,53	10
12	GDLP 500 A51	Aluminum + Resinprene	Black (recommended)	39,53	10

Profile not assembled with the rubber insert



jointec GEP - AN51

☒ For quantities below 10 pcs 10% price increase applied



Length: 4,00 meters



GD - AN
GDL - AN
H = 13 mm



AN P23 P51

The images are inserted purely for illustrative purposes

jointec >> GD in Aluminum + Insert Resinprene

L1 = mm	Art.			Finish	Variant	€ / m	pc ■
40	GD	400	AN23	Natural + Resinprene	Cement Grey	36,79	10
40	GD	400	AN51	Natural + Resinprene	Black (recommended)	36,79	10

Profile not assembled with the rubber insert

jointec >> GDL in Aluminum + Insert Resinprene

L1 = mm	Art.			Finish	Variant	€ / m	pc ■
50	GDL	500	AN23	Natural + Resinprene	Cement Grey	39,53	10
50	GDL	500	AN51	Natural + Resinprene	Black (recommended)	39,53	10

Profile not assembled with the rubber insert

Length: 4,00 meters

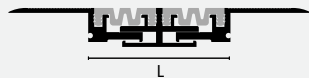

GDM 860 AN

H = 17,7 mm
AN23= AN + P23
AN51= AN + P51

jointec >> GDM in Aluminum + Insert Resinprene

L1 = mm	Art.			Finish	Variant	€ / m	pc ■
86	GDM	860	AN23	Natural + Resinprene	Cement Grey	122,75	10
86	GDM	860	AN51	Natural + Resinprene	Black (recommended)	122,75	10

Profile not assembled with the rubber insert

Roll length 40 meters

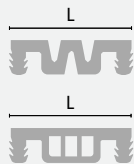

GI-P/GIL370P

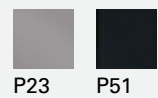

P23 P51

The images are inserted purely for illustrative purposes

jointec >> GI Insert in Resinprene standard

	L = mm	Art.			Finish	Variant	€ / m	roll ■
	37	GI	370	P23	Resinprene	Cement Grey	9,70	1
	47	GI	470	P23	Resinprene	Cement Grey	12,49	1
	37	GI	370	P51	Resinprene	Black	9,70	1
	47	GI	470	P51	Resinprene	Black	12,49	1

jointec >> GIL Insert in Resinprene with smooth surface

	L = mm	Art.			Finish	Variant	€ / m	roll ■
	37	GIL	370	P23	Resinprene	Cement Grey	9,70	1
	37	GIL	370	P51	Resinprene	Black	9,70	1

The joints are supplied unassembled from the rubber insert: GI370 or GI470 as order.
To order the insert with the smooth surface add the letter S after the article code. Ex: GE500AN51S.

☒ For quantities below 10 pcs 10% price increase applied.



jointec GD 400 A51



jointec GDM 860 AN51



Roll length 200 meters



GT 35/55 P51



P51

jointec >> GT Joint seal for industrial floors cut in site

H = mm	Art.	Finish	€ / m	roll ■
13	GT 35/55 P51	Resinil + Resinflex	0,82	1

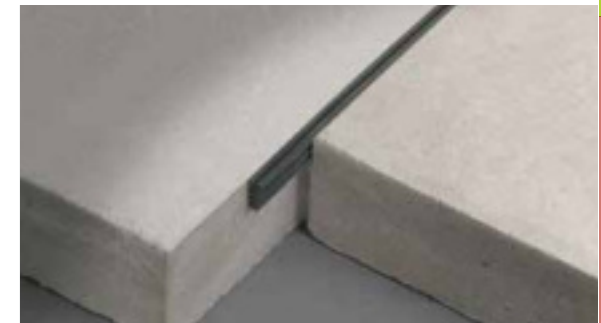

jointec GT-35/55

Length: 2,70 meters

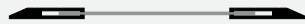
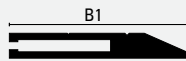

CPM 450 AS

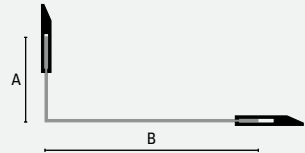

CPM*/AS



AS

The images are inserted purely for illustrative purposes

copritec >> CPM Fixing module in Anodized Aluminum for modular expansion joints

B1 = mm	Art.	Finish	Variant	€ / m	pc ■
45	CPM 450 AS	Anodized	Silver	14,38	10

Module supplied separately from the custom-made cover plate. Two modules are required to complete the joint. The silicone should be applied while assembling the module with the insert. Particularly suitable as expansion joint covers for wall or ceiling.



copritec CPML-AS + CPM 450 AS

copritec >> CPM Fixing module in Anodized Aluminum for modular expansion joints

H = mm	Art.	Finish	Variant	€ / m	pc ■
B	CPML / AS	Anodized	Silver Lateral part	107,29	
A + B	CPMP / AS	Anodized	Silver Corner	118,15	

To calculate the size of the cover plate allow 8mm of expansion within each CPM450AS module and consider the dimension of 32mm specified in the drawing as starting "0" point. Price per m2 calculated according to the development of the piece. Thickness 15/10 protected by removable film. Particularly suitable as expansion joint covers for wall or ceiling.



Length: 2,70 meters

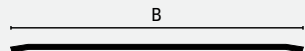

CP-IL



IL

The images are inserted purely for illustrative purposes

copritec >> CP in Stainless Steel AISI 304 - with adhesive

B = mm	Art.	Finish	Variant	€ / m	pc ■
60	CP 60 ILA	Polished	Self-Adhesive	16,89	10
80	CP 80 ILA	Polished	Self-Adhesive	21,12	10
100	CP 100 ILA	Polished	Self-Adhesive	24,58	10

Thickness 12/10 protected with a removable film.

copritec >> CP in Stainless Steel AISI 304 - with no adhesive

B = mm	Art.	Finish	Variant	€ / m	pc ■
60	CP 60 ILN	Polished	not Adhesive	14,77	10
80	CP 80 ILN	Polished	not Adhesive	19,03	10
100	CP 100 ILN	Polished	not Adhesive	22,45	10

Thickness 12/10 protected with a removable film.

☒ For quantities below 10 pcs 10% price increase applied.



Length: 2,70 meters

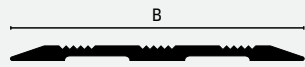

CP-AS

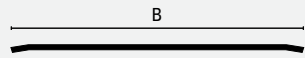

CP-OL



AS OL

The images are inserted purely for illustrative purposes

copritec >> CP in Anodized Aluminum - with adhesive

B = mm	Art.	Finish	Variant	€ / m	pc ■
80	CP 80 ASA	Anodized	Silver Self-Adhesive	17,47	10

copritec >> CP in Anodized Aluminum - with no adhesive

B = mm	Art.	Finish	Variant	€ / m	pc ■
80	CP 80 ASN	Anodized	Silver not Adhesive	15,53	10

copritec >> CP In Brass - Self-Adhesive

B = mm	Art.	Finish	Variant	€ / m	pc ■
60	CP 60 OLA	Polished	Self-Adhesive	28,48	10
80	CP 80 OLA	Polished	Self-Adhesive	36,49	10
100	CP 100 OLA	Polished	Self-Adhesive	42,96	10

Thickness 10/10 - protected with a removable film.

copritec >> CP In Brass - not Adhesive

B = mm	Art.	Finish	Variant	€ / m	pc ■
-	60 CP 60 OLN	Polished	not Adhesive	25,91	10
-	80 CP 80 OLN	Polished	not Adhesive	33,91	10
-	100 CP 100 OLN	Polished	not Adhesive	40,39	10

Thickness 10/10 - protected with a removable film.



copritec CP - AS

Length: 2,50 m

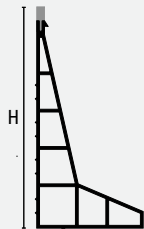

GC 80 P23

Roll length: 50 meters

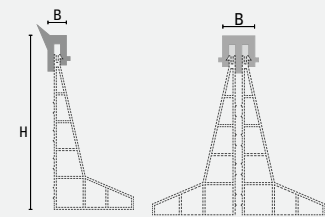

GCP 80 P23

GCR 80 P23

jointec >> GC Co-extruded Synthetic in PVC

H = mm	Art.	Finish	€ / m	pc ■
80	GC 80 P23	PVC	4,21	10

Place the top of the base module level with the finished floor surface on a 5x5m grid. Pour, cure and polish the concrete using the top of the profile as a guide.

jointec >> GCP Synthetic perimeter seal in Resinflex

H = mm	Art.	Finish	€ / m	roll ■
80	GCP 80 P23	PVC	2,99	50 m

Using the basic module GC80P23 with the specific seal you can realize a perimeter joint at the surface level, replacing foams or baseboards. Clean the joint after polishing.

jointec >> GCR Assembled joint Resinflex synthetic seal for casting

H = mm	Art.	Finish	€ / m	roll ■
80	GCR 80 P23	PVC	3,55	50 m

Use two basic modules GC80P23 with the specific seal to realize a joint for casting discontinuities. Clean the joint after polishing.



jointec GC + GCR 80 P23

✘ For quantities below 10 pcs 10% price increase applied.



Perimeter profiles for balconies and terraces

PROFILITEC offers a complete range of multipurpose perimeter profiles for balconies and terraces. Produced in stainless steel and powder-coated aluminum available in seven different colors, they present a first-rate alternative to traditional natural stone thresholds and angle profiles in ceramic tile. This product line proposes contour, transition and trim profiles for finishing tile edges as well as innovative terrace and outdoor floating floor systems.

Article	Code	Use	Pag.
Bordertec	BD	draining screed	128
Bordertec	BDC	draining screed	128
Bordertec	BBS	perimetral for terraces	129
Bordertec	BCS	perimetral for terraces	129
Bordertec	BBO	perimetral for terraces	133
Bordertec	BCO	perimetral for terraces	133
Bordertec	BHO	perimetral for terraces 2 cm	134
Bordertec	BHS	perimetral for terraces 2 cm	134
Bordertec	BD20	perimetral for terraces 2 cm	134
Bordertec	BO	perimetral for terraces	135
Bordertec	BOS	perimetral for terraces	136
Bordertec	BSJ	modular for terraces	138
Bordertec	BR	perimeter with drip stop	138
Bordertec	BTR	modular for terraces	139
Bordertec	BBR	terraces and minimal finish	139
Bordertec	BSR	for floating floors	140
Uptec	SUPA-	universal pedestals	141
Bordertec	BST	for floating floors	142





Length: 2,70 meters

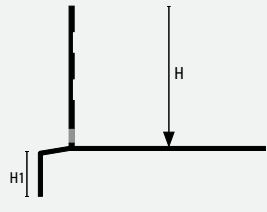

BD - A

H1 = 18 mm

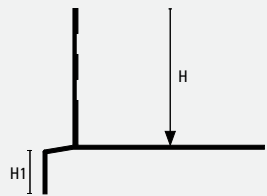

BDC - A

H1 = 18 mm



A11 A22 A32 A62



A63

The images are inserted purely for illustrative purposes

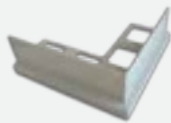

BDCE



BDE

bordertec >> BD in Powder Coated Aluminum with draining holes

H = mm	Art.	Finish	Variant	€ / m	pc ■
55	BD 55 A11	Pow. Coated	Pure White	31,11	5
75	BD 75 A11	Pow. Coated	Pure White	33,58	5
55	BD 55 A22	Pow. Coated	Pastel Grey	31,11	5
75	BD 75 A22	Pow. Coated	Pastel Grey	33,58	5
55	BD 55 A32	Pow. Coated	Dark Beige	31,11	5
75	BD 75 A32	Pow. Coated	Dark Beige	33,58	5
55	BD 55 A62	Pow. Coated	Red Brown	31,11	5
75	BD 75 A62	Pow. Coated	Red Brown	33,58	5
55	BD 55 A63	Pow. Coated	Dark Brown	31,11	5
75	BD 75 A63	Pow. Coated	Dark Brown	33,58	5

Profile to be combined with drainage matting DRAINTEC 8, pag. 147

bordertec >> BDE External Junction in Powder Coated Aluminum

H = mm	Art.	Finish	Variant	€ / pc	pc ■
55	BDE 55 A*	Pow. Coated	Choose BD color	38,14	10
75	BDE 75 A*	Pow. Coated	Choose BD color	38,14	10

bordertec >> BDC in Powder Coated Aluminum without draining holes

H = mm	Art.	Finish	Variant	€ / m	pc ■
55	BDC 55 A11	Pow. Coated	Pure White	27,42	5
75	BDC 75 A11	Pow. Coated	Pure White	29,89	5
55	BDC 55 A22	Pow. Coated	Pastel Grey	27,42	5
75	BDC 75 A22	Pow. Coated	Pastel Grey	29,89	5
55	BDC 55 A32	Pow. Coated	Dark Beige	27,42	5
75	BDC 75 A32	Pow. Coated	Dark Beige	29,89	5
55	BDC 55 A62	Pow. Coated	Red Brown	27,42	5
75	BDC 75 A62	Pow. Coated	Red Brown	29,89	5
55	BDC 55 A63	Pow. Coated	Dark Brown	27,42	5
75	BDC 75 A63	Pow. Coated	Dark Brown	29,89	5

Profile to be combined with drainage matting DRAINTEC 8, pag. 145

bordertec >> BDCE External Junction in Powder Coated Aluminum

H = mm	Art.	Finish	Variant	€ / pc	pc ■
55	BDCE 55 A*	Pow. Coated	Choose BDC color	35,79	10
75	BDCE 75 A*	Pow. Coated	Choose BDC color	35,79	10

bordertec >> BDG Joint in Powder Coated Aluminum

H = mm	Art.	Finish	Variant	€ / pc	pc ■
55	BDG 55 A*	Pow. Coated	Choose BD color	7,37	10
75	BDG 75 A*	Pow. Coated	Choose BD color	7,37	10



bordertec BD A22

✘ For quantities below 10 pcs 10% price increase applied.



Length: 2,70 meters

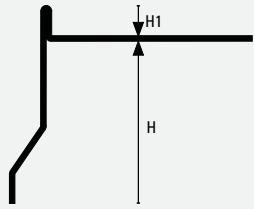

BBS - IL
H1 = 10 mm

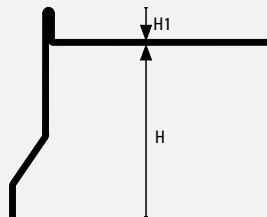

BCS - IL
H1 = 12,5 mm



IL

The images are inserted purely for illustrative purposes

bordertec >> BBS in Stainless Steel Polished AISI 304 - DIN 1.4301

H = mm	Art.	Finish	€ / m	pc ■
42	BBS 42 IL	Polished	30,34	5
55	BBS 55 IL	Polished	34,23	5
75	BBS 75 IL	Polished	38,09	5
95	BBS 95 IL	Polished	42,37	5

bordertec >> BBSE External corner in Stainless Steel AISI 304 - DIN 1.4301

H = mm	Art.	Finish	€ / pc	set ■
42	BBSE 42 IL	Polished	45,22	10
55	BBSE 55 IL	Polished	45,22	10
75	BBSE 75 IL	Polished	45,22	10
95	BBSE 95 IL	Polished	45,22	10

bordertec >> BBSG Joint in Stainless Steel AISI 304 - DIN 1.4301

H = mm	Art.	Finish	€ / pc	set ■
42	BBSG 42 IL	Polished	7,32	10
55	BBSG 55 IL	Polished	7,32	10
75	BBSG 75 IL	Polished	7,32	10
95	BBSG 95 IL	Polished	7,32	10

bordertec >> BCS in Stainless Steel Polished AISI 304 - DIN 1.4301

H = mm	Art.	Finish	€ / m	pc ■
42	BCS 42 IL	Polished	30,34	5
55	BCS 55 IL	Polished	34,23	5
75	BCS 75 IL	Polished	38,09	5
95	BCS 95 IL	Polished	42,37	5

bordertec >> BCSE External corner in Stainless Steel AISI 304 - DIN 1.4301

H = mm	Art.	Finish	€ / pc	set ■
42	BCSE 42 IL	Polished	45,22	10
55	BCSE 55 IL	Polished	45,22	10
75	BCSE 75 IL	Polished	45,22	10
95	BCSE 95 IL	Polished	45,22	10

bordertec >> BCSG Joint in Stainless Steel AISI 304 - DIN 1.4301

H = mm	Art.	Finish	€ / pc	set ■
42	BCSG 42 IL	Polished	7,32	10
55	BCSG 55 IL	Polished	7,32	10
75	BCSG 75 IL	Polished	7,32	10
95	BCSG 95 IL	Polished	7,32	10



bordertec BBS

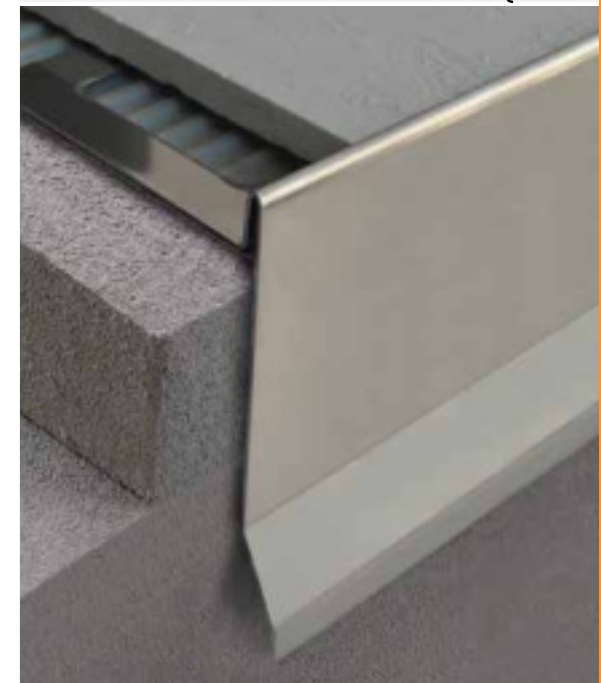

perimtral for terraces

terraces



Length: 2,70 meters

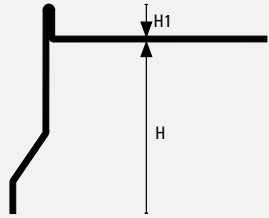

BBS - A

H1 = 10 mm

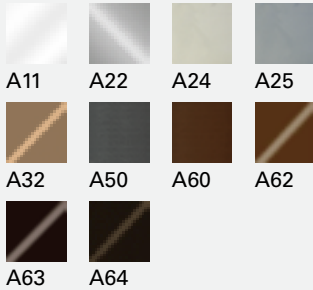

The images are inserted purely for illustrative purposes



BBSE

bordertec >> BBS in Powder Coated Aluminum

H = mm	Art.	Finish	Variant	€ / m	pc ■
42	BBS 42 A11	Pow. Coated	Pure White	18,35	10
55	BBS 55 A11	Pow. Coated	Pure White	21,12	5
75	BBS 75 A11	Pow. Coated	Pure White	24,41	5
95	BBS 95 A11	Pow. Coated	Pure White	27,88	5
42	BBS 42 A22	Pow. Coated	Pastel Grey	18,35	10
55	BBS 55 A22	Pow. Coated	Pastel Grey	21,12	5
75	BBS 75 A22	Pow. Coated	Pastel Grey	24,41	5
95	BBS 95 A22	Pow. Coated	Pastel Grey	27,88	5
42	BBS 42 A32	Pow. Coated	Dark Beige	18,35	10
55	BBS 55 A32	Pow. Coated	Dark Beige	21,12	5
75	BBS 75 A32	Pow. Coated	Dark Beige	24,41	5
95	BBS 95 A32	Pow. Coated	Dark Beige	27,88	5
42	BBS 42 A62	Pow. Coated	Red Brown	18,35	10
55	BBS 55 A62	Pow. Coated	Red Brown	21,12	5
75	BBS 75 A62	Pow. Coated	Red Brown	24,41	5
95	BBS 95 A62	Pow. Coated	Red Brown	27,88	5
42	BBS 42 A63	Pow. Coated	Dark Brown	18,35	10
55	BBS 55 A63	Pow. Coated	Dark Brown	21,12	5
75	BBS 75 A63	Pow. Coated	Dark Brown	24,41	5
95	BBS 95 A63	Pow. Coated	Dark Brown	27,88	5

bordertec >> BBS in Powder Coated Aluminum Modern Line

H = mm	Art.	Finish	Variant	€ / m	pc ■
42	BBS 42 A24	Pow. Coated	Embossed Pastel Grey	18,35	10
55	BBS 55 A24	Pow. Coated	Embossed Pastel Grey	21,12	5
75	BBS 75 A24	Pow. Coated	Embossed Pastel Grey	24,41	5
95	BBS 95 A24	Pow. Coated	Embossed Pastel Grey	27,88	5
42	BBS 42 A25	Pow. Coated	Embossed Cement Grey	18,35	10
55	BBS 55 A25	Pow. Coated	Embossed Cement Grey	21,12	5
75	BBS 75 A25	Pow. Coated	Embossed Cement Grey	24,41	5
95	BBS 95 A25	Pow. Coated	Embossed Cement Grey	27,88	5
42	BBS 42 A50	Pow. Coated	Embossed Micaceous	18,35	10
55	BBS 55 A50	Pow. Coated	Embossed Micaceous	21,12	5
75	BBS 75 A50	Pow. Coated	Embossed Micaceous	24,41	5
95	BBS 95 A50	Pow. Coated	Embossed Micaceous	27,88	5
42	BBS 42 A60	Pow. Coated	Embossed Corten	18,35	10
55	BBS 55 A60	Pow. Coated	Embossed Corten	21,12	5
75	BBS 75 A60	Pow. Coated	Embossed Corten	24,41	5
95	BBS 95 A60	Pow. Coated	Embossed Corten	27,88	5
42	BBS 42 A64	Pow. Coated	Embossed Dark Brown	18,35	10
55	BBS 55 A64	Pow. Coated	Embossed Dark Brown	21,12	5
75	BBS 75 A64	Pow. Coated	Embossed Dark Brown	24,41	5
95	BBS 95 A64	Pow. Coated	Embossed Dark Brown	27,88	5

bordertec >> BBSE External corner in Powder Coated Aluminum and Modern Line

H = mm	Art.	Finish	Variant	€ / pc	pc ■
42	BBSE 42 A*	Pow. Coated	Choose BBS color	30,57	10
55	BBSE 55 A*	Pow. Coated	Choose BBS color	30,57	10
75	BBSE 75 A*	Pow. Coated	Choose BBS color	30,57	10
95	BBSE 95 A*	Pow. Coated	Choose BBS color	30,57	10

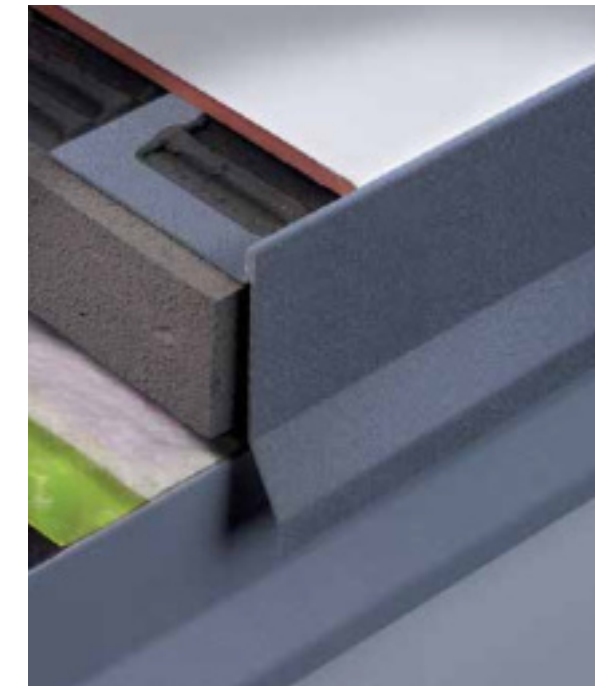

bordertec BBS A50

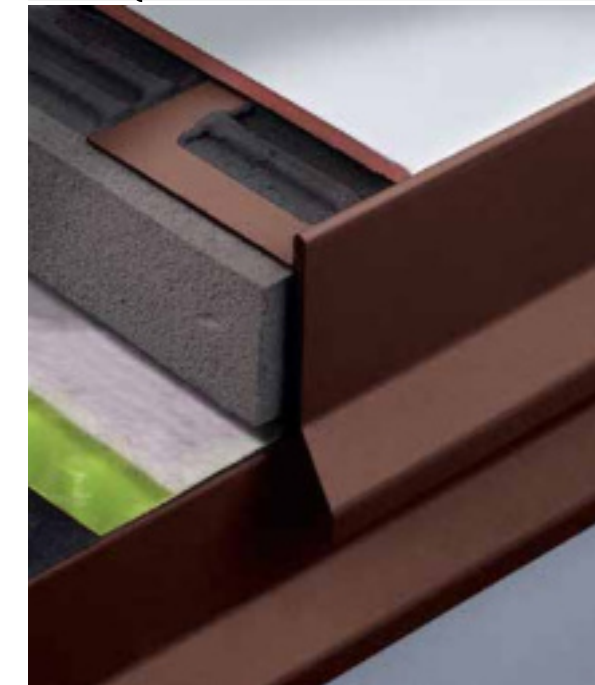

bordertec BBS A60

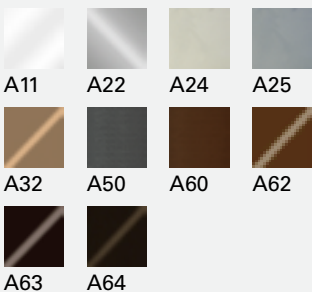

The images are inserted purely for illustrative purposes



BBSI 42

bordertec >> BBSI Internal corner in Powder Coated Aluminum and Modern Line

H = mm	Art.	Finish	Variant	€ / pc	pc ■
42	BBSI 42 A*	Pow. Coated	Available 11/22/50	30,57	10
55	BBSI 55 A*	Pow. Coated	Available 11/22/50	30,57	10

The article BBSI-A is available only in 11/22/50 Colors.

bordertec >> BBSG Joint in Powder Coated Aluminum and Modern Line

H = mm	Art.	Finish	Variant	€ / pc	pc ■
42	BBSG 42 A*	Pow. Coated	Choose BBS color	6,02	10
55	BBSG 55 A*	Pow. Coated	Choose BBS color	6,02	10
75	BBSG 75 A*	Pow. Coated	Choose BBS color	6,02	10
95	BBSG 95 A*	Pow. Coated	Choose BBS color	6,02	10

bordertec >> BBSGT Joint in Powder Coated Aluminum

H = mm	Art.	Finish	Variant	€ / pc	pc ■
42	BBSGT 42 A22	Pow. Coated	Pastel Grey	10,52	10

BBSGT joints to be used for terraces with columns anchored on the mortar bed.



Embossed finishes



- + Greater impact resistance
- + Greater scratch resistanc
- + Minor sunlight reflection



bordertec BBSE + BBSG



☒ For quantities below 10 pcs 10% price increase applied.



Length: 2,70 meters

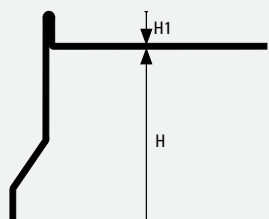

BCS - A
BCS - IL

H1 = 12,5 mm

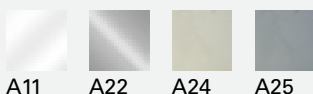

A11 A22 A24 A25



A32 A50 A60 A62

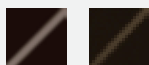

A63 A64

The images are inserted purely for illustrative purposes

bordertec >> BCS in Powder Coated Aluminum

H = mm	Art.	Finish	Variant	€ / m	pc ■
42	BCS 42 A11	Pow. Coated	Pure White	18,35	10
55	BCS 55 A11	Pow. Coated	Pure White	21,12	5
75	BCS 75 A11	Pow. Coated	Pure White	24,41	5
95	BCS 95 A11	Pow. Coated	Pure White	27,88	5
42	BCS 42 A22	Pow. Coated	Pastel Grey	18,35	10
55	BCS 55 A22	Pow. Coated	Pastel Grey	21,12	5
75	BCS 75 A22	Pow. Coated	Pastel Grey	24,41	5
95	BCS 95 A22	Pow. Coated	Pastel Grey	27,88	5
42	BCS 42 A32	Pow. Coated	Dark Beige	18,35	10
55	BCS 55 A32	Pow. Coated	Dark Beige	21,12	5
75	BCS 75 A32	Pow. Coated	Dark Beige	24,41	5
95	BCS 95 A32	Pow. Coated	Dark Beige	27,88	5
42	BCS 42 A62	Pow. Coated	Red Brown	18,35	10
55	BCS 55 A62	Pow. Coated	Red Brown	21,12	5
75	BCS 75 A62	Pow. Coated	Red Brown	24,41	5
95	BCS 95 A62	Pow. Coated	Red Brown	27,88	5
42	BCS 42 A63	Pow. Coated	Dark Brown	18,35	10
55	BCS 55 A63	Pow. Coated	Dark Brown	21,12	5
75	BCS 75 A63	Pow. Coated	Dark Brown	24,41	5
95	BCS 95 A63	Pow. Coated	Dark Brown	27,88	5

bordertec >> BCS in Powder Coated Aluminum Modern Line

H = mm	Art.	Finish	Variant	€ / m	pc ■
42	BCS 42 A24	Pow. Coated	Embossed Pastel Grey	18,35	10
42	BCS 42 A25	Pow. Coated	Embossed Cement Grey	18,35	10
42	BCS 42 A50	Pow. Coated	Embossed Micaceous	18,35	10
55	BCS 55 A50	Pow. Coated	Embossed Micaceous	21,12	5
75	BCS 75 A50	Pow. Coated	Embossed Micaceous	24,41	5
95	BCS 95 A50	Pow. Coated	Embossed Micaceous	27,88	5
42	BCS 42 A60	Pow. Coated	Embossed Corten	18,35	10
55	BCS 55 A60	Pow. Coated	Embossed Corten	21,12	5
75	BCS 75 A60	Pow. Coated	Embossed Corten	24,41	5
95	BCS 95 A60	Pow. Coated	Embossed Corten	27,88	5
42	BCS 42 A64	Pow. Coated	Embossed Dark Brown	18,35	10

bordertec >> BCSE External corner in Powder Coated Aluminum

H = mm	Art.	Finish	Variant	€ / pc	pc ■
42	BCSE 42 A*	Pow. Coated	Choose BCS color	30,57	10
55	BCSE 55 A*	Pow. Coated	Choose BCS color	30,57	10
75	BCSE 75 A*	Pow. Coated	Choose BCS color	30,57	10
95	BCSE 95 A*	Pow. Coated	Choose BCS color	30,57	10

bordertec >> BCSG Joint in Powder Coated Aluminum

H = mm	Art.	Finish	Variant	€ / pc	pc ■
42	BCSG 42 A*	Pow. Coated	Choose BCS color	6,02	10
55	BCSG 55 A*	Pow. Coated	Choose BCS color	6,02	10
75	BCSG 75 A*	Pow. Coated	Choose BCS color	6,02	10
95	BCSG 95 A*	Pow. Coated	Choose BCS color	6,02	10

bordertec >> BBSGT Joint in Powder Coated Aluminum

H = mm	Art.	Finish	Variant	€ / pc	pc ■
42	BBSGT 42 A22	Pow. Coated	Pastel Grey	10,52	10

BBSGT joints to be used for terraces with columns anchored on the mortar bed.

✘ For quantities below 10 pcs 10% price increase applied.



bordertec BCS 42 A62



bordertec BCS 42 A64



Length: 2,70 meters

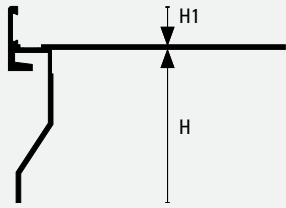

BBO - A
H1 = 10 mm

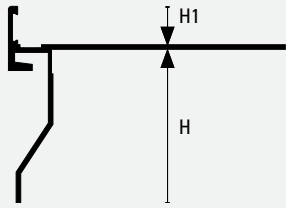

BCO - A
H1 = 12,5 mm

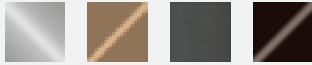

A22 A32 A50 A63

The images are inserted purely for illustrative purposes

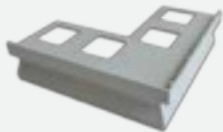

BBOE

bordertec >> BBO in Powder Coated Aluminum

H = mm	Art.	Finish	Variant	€ / m	pc ■
50	BBO 50 A22	Pow. Coated	Pastel Grey	28,04	5

bordertec >> BBO in Powder Coated Aluminum Modern Line

H = mm	Art.	Finish	Variant	€ / m	pc ■
50	BBO 50 A50	Pow. Coated	Embossed Micaceous	28,04	5

bordertec >> BBOE External Junction in Powder Coated Aluminum

H = mm	Art.	Finish	Variant	€ / pc	set ■
50	BBOE 50 A*	Pow. Coated	Choose BBO color	35,87	10

bordertec >> BBOG Joint in Powder Coated Aluminum

H = mm	Art.	Finish	Variant	€ / pc	set ■
50	BBOG 50 A*	Pow. Coated	Choose BBO color	7,21	10

bordertec >> BCO in Powder Coated Aluminum

H = mm	Art.	Finish	Variant	€ / m	pc ■
50	BCO 50 A22	Pow. Coated	Pastel Grey	28,04	5
50	BCO 50 A32	Pow. Coated	Dark Beige	28,04	5
50	BCO 50 A63	Pow. Coated	Dark Brown	28,04	5

bordertec >> BCO in Powder Coated Aluminum Modern Line

H = mm	Art.	Finish	Variant	€ / m	pc ■
50	BCO 50 A50	Pow. Coated	Embossed Micaceous	28,04	5

bordertec >> BCOE External Junction in Powder Coated Aluminum

H = mm	Art.	Finish	Variant	€ / pc	set ■
50	BCOE 50 A*	Pow. Coated	Choose BCO color	35,87	10

bordertec >> BCOG Joint in Powder Coated Aluminum

H = mm	Art.	Finish	Variant	€ / pc	set ■
50	BCOG 50 A*	Pow. Coated	Choose BCO color	7,21	10



bordertec BBO 50 A50

☒ For quantities below 10 pcs 10% price increase applied.



Length: 2,70 meters

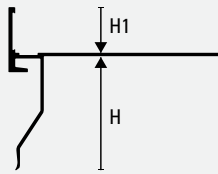

BHO - A
H1 = 20 mm



BHOG - A22

bordertec >> BHO in painted Aluminum

	H = mm	Art.	Finish	Variant	€ / m	pc ■
new	50	BHO 50 A22	Pow. Coated	Pastel Grey	30,85	5
new	50	BHO 50 A50	Pow. Coated	Embossed Micaceous	30,85	5

bordertec >> BHOE External joint in painted Aluminum

	H = mm	Art.	Finish	Variant	€ / pc	pc ■
new	50	BHOE 50 A*	Pow. Coated	BHO available in different colours	39,46	10

bordertec >> BHOG Joint in painted Aluminum

	H = mm	Art.	Finish	Variant	€ / pc	pc ■
new	50	BHOG 50 A*	Pow. Coated	BHO available in different colours	7,92	10

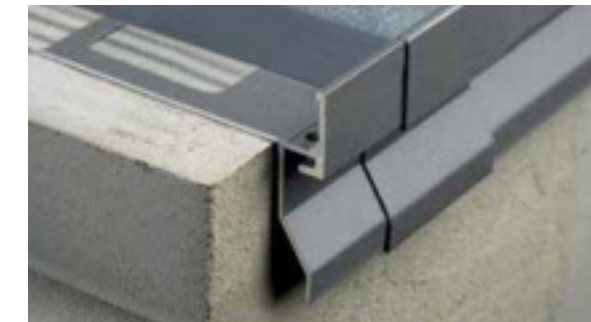

bordertec BHO 50 A50

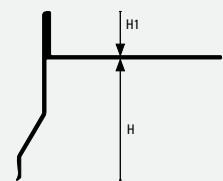

BHS - A
H1 = 20 mm

bordertec >> BHS in painted Aluminum

	H = mm	Art.	Finish	Variant	€ / m	pc ■
new	55	BHS 55 A22	Pow. Coated	Pastel Grey	23,22	5
new	55	BHS 55 A50	Pow. Coated	Embossed Micaceous	23,22	5

bordertec >> BHSE External joint in painted Aluminum

	H = mm	Art.	Finish	Variant	€ / pc	pc ■
new	55	BHSE 55 A*	Pow. Coated	BHS available in different colours	33,63	10

bordertec >> BHSG Joint in painted Aluminum

	H = mm	Art.	Finish	Variant	€ / pc	pc ■
new	55	BHSG 55 A*	Pow. Coated	BHS available in different colours	6,61	10



bordertec BHS 55 A50

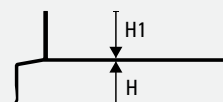

BD20 - A
H1 = 20 mm



A22 A50

The images are inserted purely for illustrative purposes

bordertec >> BD20 in painted Aluminum

	H = mm	Art.	Finish	Variant	€ / m	pc ■
new	20	BD 20 A22	Pow. Coated	Pastel Grey	24,89	5
new	20	BD 20 A50	Pow. Coated	Embossed Micaceous	24,89	5

bordertec >> BDE20 External joint in painted Aluminum

	H = mm	Art.	Finish	Variant	€ / pc	pc ■
new	20	BDE 20 A*	Pow. Coated	BD20 available in different colours	30,51	10

bordertec >> BDG20 Joint in painted Aluminum

	H = mm	Art.	Finish	Variant	€ / pc	pc ■
new	20	BDG 20 A*	Pow. Coated	BD20 available in different colours	5,88	10

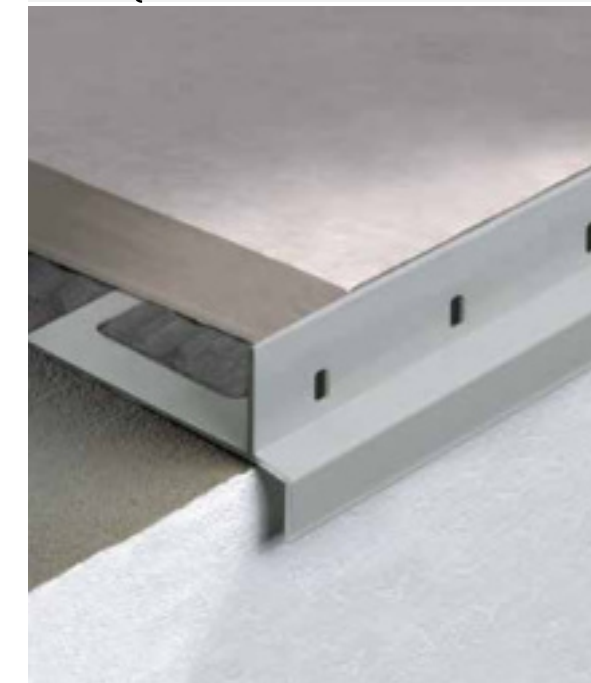

bordertec BD20 A22

✗ For quantities below 10 pcs 10% price increase applied.

Length: 2,70 meters

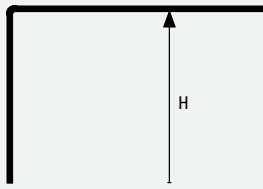

BO - IL
BO - A



IL A11 A22 A32



A62 A63

The images are inserted purely for illustrative purposes

bordertec >> BO in Stainless Steel Polished AISI 304 - DIN 1.4301

H = mm	Art.	Finish	€ / m	pc ■
30	BO 30 IL	Polished	26,80	5
42	BO 42 IL	Polished	28,38	5
55	BO 55 IL	Polished	31,12	5
75	BO 75 IL	Polished	34,69	5
95	BO 95 IL	Polished	38,21	5

bordertec >> BOE External corner in Stainless Steel AISI 304 - DIN 1.4301

H = mm	Art.	Finish	€ / pc	set ■
30	BOE 30 IL	Polished	36,72	10
42	BOE 42 IL	Polished	36,72	10
55	BOE 55 IL	Polished	36,72	10
75	BOE 75 IL	Polished	36,72	10
95	BOE 95 IL	Polished	36,72	10

bordertec >> BOG Joint in Stainless Steel AISI 304 - DIN 1.4301

H = mm	Art.	Finish	€ / pc	set ■
30	BOG 30 IL	Polished	6,83	10
42	BOG 42 IL	Polished	6,83	10
55	BOG 55 IL	Polished	6,83	10
75	BOG 75 IL	Polished	6,83	10
95	BOG 95 IL	Polished	6,83	10

bordertec >> BO in Powder Coated Aluminum

H = mm	Art.	Finish	Variant	€ / m	pc ■
30	BO 30 A11	Pow. Coated	Pure White	15,22	5
42	BO 42 A11	Pow. Coated	Pure White	16,13	5
55	BO 55 A11	Pow. Coated	Pure White	18,80	10
75	BO 75 A11	Pow. Coated	Pure White	21,67	10
95	BO 95 A11	Pow. Coated	Pure White	24,40	10
30	BO 30 A22	Pow. Coated	Pastel Grey	15,22	5
42	BO 42 A22	Pow. Coated	Pastel Grey	16,13	5
55	BO 55 A22	Pow. Coated	Pastel Grey	18,80	10
75	BO 75 A22	Pow. Coated	Pastel Grey	21,67	10
95	BO 95 A22	Pow. Coated	Pastel Grey	24,40	10
30	BO 30 A32	Pow. Coated	Dark Beige	15,22	5
42	BO 42 A32	Pow. Coated	Dark Beige	16,13	5
55	BO 55 A32	Pow. Coated	Dark Beige	18,80	10
75	BO 75 A32	Pow. Coated	Dark Beige	21,67	10
95	BO 95 A32	Pow. Coated	Dark Beige	24,40	10
30	BO 30 A62	Pow. Coated	Red Brown	15,22	5
42	BO 42 A62	Pow. Coated	Red Brown	16,13	5
55	BO 55 A62	Pow. Coated	Red Brown	18,80	10
75	BO 75 A62	Pow. Coated	Red Brown	21,67	10
95	BO 95 A62	Pow. Coated	Red Brown	24,40	10
30	BO 30 A63	Pow. Coated	Dark Brown	15,22	5
42	BO 42 A63	Pow. Coated	Dark Brown	16,13	5
55	BO 55 A63	Pow. Coated	Dark Brown	18,80	10
75	BO 75 A63	Pow. Coated	Dark Brown	21,67	10
95	BO 95 A63	Pow. Coated	Dark Brown	24,40	10

☒ For quantities below 10 pcs 10% price increase applied.



bordertec BO A63

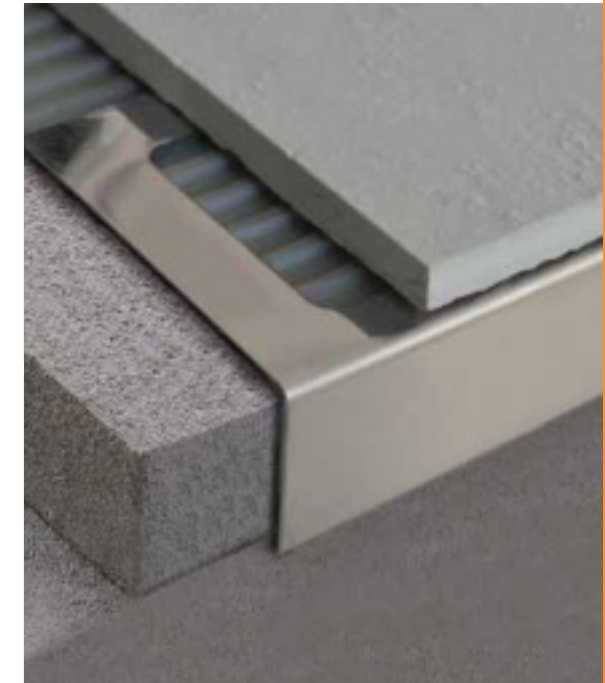

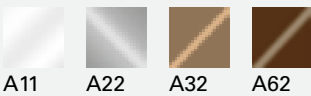

A11 A22 A32 A62



A63

The images are inserted purely for illustrative purposes

bordertec >> BOE External corner in Powder Coated Aluminum

H = mm	Art.	Finish	Variant	€ / pc	set ■
30	BOE 30 A*	Pow. Coated	Choose BO color	24,97	10
42	BOE 42 A*	Pow. Coated	Choose BO color	24,97	10
55	BOE 55 A*	Pow. Coated	Choose BO color	24,97	10
75	BOE 75 A*	Pow. Coated	Choose BO color	24,97	10
95	BOE 95 A*	Pow. Coated	Choose BO color	24,97	10

bordertec >> BOG Joint in Powder Coated Aluminum

H = mm	Art.	Finish	Variant	€ / pc	set ■
30	BOG 30 A*	Pow. Coated	Choose BO color	5,81	10
42	BOG 42 A*	Pow. Coated	Choose BO color	5,81	10
55	BOG 55 A*	Pow. Coated	Choose BO color	5,81	10
75	BOG 75 A*	Pow. Coated	Choose BO color	5,81	10
95	BOG 95 A*	Pow. Coated	Choose BO color	5,81	10

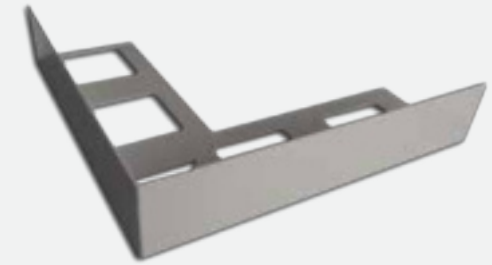

bordertec BOE A22



bordertec BOG A22



bordertec BOS-IL

Length: 2,70 meters

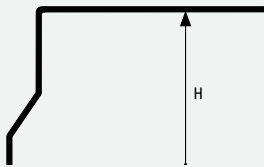

BOS - IL



IL

The images are inserted purely for illustrative purposes

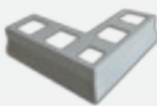

BOSE

bordertec >> BOS in Stainless Steel Polished AISI 304 - DIN 1.4301

H = mm	Art.	Finish	€ / m	pc ■
42	BOS 42 IL	Polished	29,56	5
55	BOS 55 IL	Polished	32,70	5
75	BOS 75 IL	Polished	36,64	5
95	BOS 95 IL	Polished	40,60	5

bordertec >> BOSE External corner in Stainless Steel AISI 304 - DIN 1.4301

H = mm	Art.	Finish	€ / pc	set ■
42	BOSE 42 IL	Polished	45,83	10
55	BOSE 55 IL	Polished	45,83	10
75	BOSE 75 IL	Polished	45,83	10
95	BOSE 95 IL	Polished	45,83	10

bordertec >> BOSG Joint in Stainless Steel AISI 304 - DIN 1.4301

H = mm	Art.	Finish	€ / pc	set ■
42	BOSG 42 IL	Polished	7,43	10
55	BOSG 55 IL	Polished	7,43	10
75	BOSG 75 IL	Polished	7,43	10
95	BOSG 95 IL	Polished	7,43	10

✘ For quantities below 10 pcs 10% price increase applied.

Length: 2,70 meters

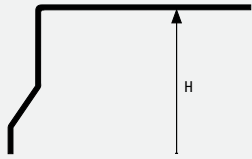

BOS - A



A11 A22 A32 A62



A63

The images are inserted purely for illustrative purposes

bordertec >> BOS in Powder Coated Aluminum

H = mm	Art.	Finish	Variant	€ / m	pc ■
42	BOS 42 A11	Pow. Coated	Pure White	17,70	5
55	BOS 55 A11	Pow. Coated	Pure White	20,24	10
75	BOS 75 A11	Pow. Coated	Pure White	23,24	10
95	BOS 95 A11	Pow. Coated	Pure White	26,55	10
42	BOS 42 A22	Pow. Coated	Pastel Grey	17,70	5
55	BOS 55 A22	Pow. Coated	Pastel Grey	20,24	10
75	BOS 75 A22	Pow. Coated	Pastel Grey	23,24	10
95	BOS 95 A22	Pow. Coated	Pastel Grey	26,55	10
42	BOS 42 A32	Pow. Coated	Dark Beige	17,70	5
55	BOS 55 A32	Pow. Coated	Dark Beige	20,24	10
75	BOS 75 A32	Pow. Coated	Dark Beige	23,24	10
95	BOS 95 A32	Pow. Coated	Dark Beige	26,55	10
42	BOS 42 A62	Pow. Coated	Red Brown	17,70	5
55	BOS 55 A62	Pow. Coated	Red Brown	20,24	10
75	BOS 75 A62	Pow. Coated	Red Brown	23,24	10
95	BOS 95 A62	Pow. Coated	Red Brown	26,55	10
42	BOS 42 A63	Pow. Coated	Dark Brown	17,70	5
55	BOS 55 A63	Pow. Coated	Dark Brown	20,24	10
75	BOS 75 A63	Pow. Coated	Dark Brown	23,24	10
95	BOS 95 A63	Pow. Coated	Dark Brown	26,55	10

bordertec >> BOSE External corner in Powder Coated Aluminum

H = mm	Art.	Finish	Variant	€ / pc	set ■
42	BOSE 42 A*	Pow. Coated	Choose BOS color	30,98	10
55	BOSE 55 A*	Pow. Coated	Choose BOS color	30,98	10
75	BOSE 75 A*	Pow. Coated	Choose BOS color	30,98	10
95	BOSE 95 A*	Pow. Coated	Choose BOS color	30,98	10

bordertec >> BOSG Joint in Powder Coated Aluminum

H = mm	Art.	Finish	Variant	€ / pc	set ■
42	BOSG 42 A*	Pow. Coated	Choose BOS color	6,10	10
55	BOSG 55 A*	Pow. Coated	Choose BOS color	6,10	10
75	BOSG 75 A*	Pow. Coated	Choose BOS color	6,10	10
95	BOSG 95 A*	Pow. Coated	Choose BOS color	6,10	10



bordertec BOS 55 A63

☒ For quantities below 10 pcs 10% price increase applied.



Length: 2,70 meters

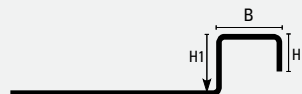

BSJ 20 A* - I*

H1 = 20 mm

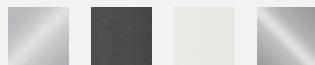

IS A50 A13 A22



A65

The images are inserted purely for illustrative purposes

bordertec >> BSJ in Brushed Stainless Steel

BxH = mm	Art.	Finish	€/ m	pc ■
20 x 12	BSJ 20 IS	Brushed	39,23	10

bordertec >> BSJE External Junction in brushed Stainless Steel

B = mm	Art.	Finish	Variant	€/ pc	pc ■
20	BSJE 20 IS	Brushed	Brushed	49,78	10

bordertec >> BSJ in Power Coated Aluminum

BxH = mm	Art.	Finish	Variant	€/ m	pc ■
20 x 12	BSJ 20 A50	Pow. Coated	Embossed Micaceous	21,21	10
new 20 x 12	BSJ 20 A13	Pow. Coated	Embossed Antique White	21,21	10
new 20 x 12	BSJ 20 A22	Pow. Coated	Pastel Grey	21,21	10
new 20 x 12	BSJ 20 A65	Pow. Coated	Embossed matt Black	21,21	10

bordertec >> BSJE External Junction in Power Coated Aluminum

B = mm	Art.	Finish	Variant	€/ pc	set ■
20	BSJE 20 A50	Pow. Coated	Embossed Micaceous	33,58	10
new 20	BSJE 20 A13	Pow. Coated	Antique White	33,58	10
new 20	BSJE 20 A65	Pow. Coated	Embossed matt Black	33,58	10
new 20	BSJE 20 A22	Pow. Coated	Pastel Grey	33,58	10



bordertec BSJ 20 A50

Length: 2,70 meters

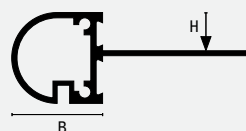

BR - A

B = 24 mm

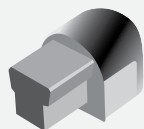

BRE - A

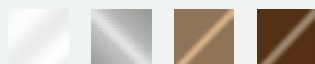

A11 A22 A32 A62



A63

The images are inserted purely for illustrative purposes

bordertec >> BR in Powder Coated Aluminum

H = mm	Art.	Finish	Variant	€/ m	pc ■
8	BR 80 A11	Pow. Coated	Pure White	15,64	10
10	BR 100 A11	Pow. Coated	Pure White	15,64	10
8	BR 80 A22	Pow. Coated	Pastel Grey	15,64	10
10	BR 100 A22	Pow. Coated	Pastel Grey	15,64	10
8	BR 80 A32	Pow. Coated	Dark Beige	15,64	10
10	BR 100 A32	Pow. Coated	Dark Beige	15,64	10
8	BR 80 A62	Pow. Coated	Red Brown	15,64	10
10	BR 100 A62	Pow. Coated	Red Brown	15,64	10
8	BR 80 A63	Pow. Coated	Dark Brown	15,64	10
10	BR 100 A63	Pow. Coated	Dark Brown	15,64	10

bordertec >> BRE External Junction in Powder Coated Aluminum

Art.	Finish	Variant	€/ pc	set ■
BRE 80/100 A*	Pow. Coated	Choose BR color	11,81	10

The external junction and the joint piece suit profiles of both heights.

bordertec >> BRG Joint in Powder Coated Aluminum

Art.	Finish	Variant	€/ pc	set ■
BRG 80/100 A*	Pow. Coated	Choose BR color	5,19	10

The external junction and the joint piece suit profiles of both heights.



bordertec BRA22

✘ For quantities below 20 pcs 10% price increase applied.



Length: 2,70 meters

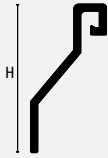

BTR 30 AS

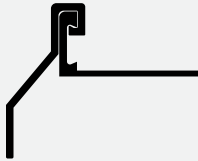

BTR 30 AS + TR - AS



AS

The images are inserted purely for illustrative purposes

bordertec >> BTR Water drip profile in Anod. Alum. to assemble with series TR

H = mm	Art.	Finish	Variant	€ / m	pc ■
30	BTR 30 AS	Anodized	Silver	7,41	20

Once assembled with TR profile the height is raised by 2mm (tile thickness reduced by 2mm).

bordertec >> TR Profile in Anodized Aluminum

H = mm	Art.	Finish	Variant	€ / m	pc ■
4,5	TR 45 AS	Anodized	Silver	3,89	40
6	TR 60 AS	Anodized	Silver	4,04	40
8	TR 80 AS	Anodized	Silver	4,18	40
10	TR 100 AS	Anodized	Silver	4,38	40
11	TR 110 AS	Anodized	Silver	4,71	40
12,5	TR 125 AS	Anodized	Silver	5,01	40
15	TR 150 AS	Anodized	Silver	5,45	40
17,5	TR 175 AS	Anodized	Silver	5,91	30
20	TR 200 AS	Anodized	Silver	6,35	30



Water drip profile BTR

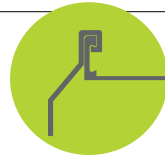

- + It can be used with TR- profile to fit any tile height
- + Reduced stock
- + Strong mechanical coupling

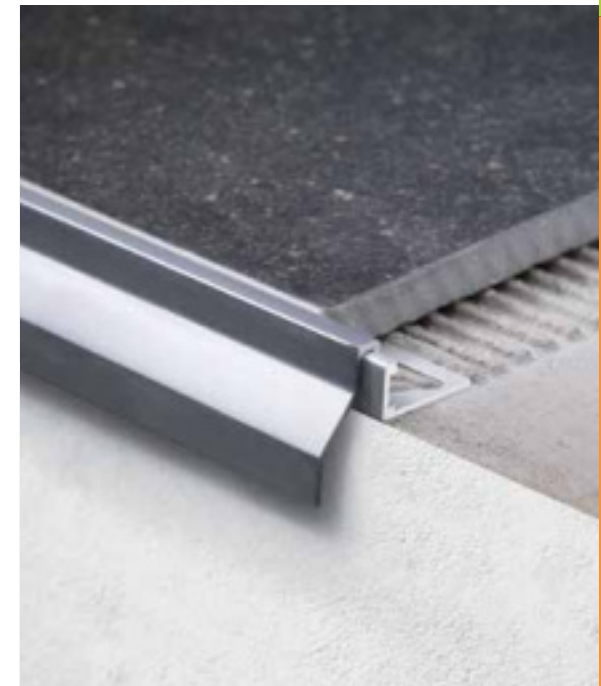

border+tec BTR 30 AS + TR AS

Length: 2,70 meters

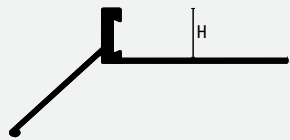

BBR 100 A



AS A24 A25 A64

The images are inserted purely for illustrative purposes

bordertec >> BBR shorter border in Anodized Aluminum

H = mm	Art.	Finish	Variant	€ / m	pc ■
10	BBR 100 AS	Anodized	Silver	6,89	10

bordertec >> BBR shorter border in Powder Coated Aluminum Modern Line

H = mm	Art.	Finish	Variant	€ / m	pc ■
10	BBR 100 A24	Pow. Coated	Embossed Pastel Grey	8,97	10
10	BBR 100 A25	Pow. Coated	Embossed Cement Grey	8,97	10
10	BBR 100 A64	Pow. Coated	Embossed Dark Brown	8,97	10



border+tec BBR 100 A24

☒ For quantities below 20 pcs 10% price increase applied.



Length: 2,70 meters

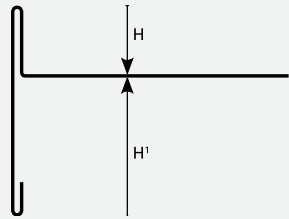

BSR - IL

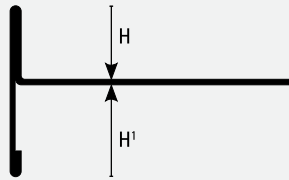

BSR - A

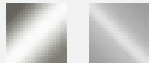

IL A22

The images are inserted purely for illustrative purposes

bordertec >> BSR Reversible profile in Stainless Steel AISI 304 - DIN 1.4301

H/H1 mm	Art.	Finish	€ / m	pc ■
10/35	BSR 10/35 IL	Polished	32,64	10
15/30	BSR 15/30 IL	Polished	32,64	10
20/25	BSR 20/25 IL	Polished	32,64	10

bordertec >> BSRE External Junction in Stainless Steel AISI 304 - DIN 1.4301

Art.	Finish	€ / pc	pc ■
BSRE 45 IL	Polished	39,89	10

Universal joint: suitable for all sizes.

bordertec >> BSRG Joint in Stainless Steel AISI 304 - DIN 1.4301

Art.	Finish	€ / pc	pc ■
BSRG 45 IL	Polished	7,27	10

Universal joint: suitable for all sizes.

bordertec >> BSR Reversible profile in Powder Coated Aluminum

H/H1 mm	Art.	Finish	Variant	€ / m	pc ■
10/35	BSR 10/35 A22	Pow. Coated	Pastel Grey	21,38	10
15/30	BSR 15/30 A22	Pow. Coated	Pastel Grey	21,38	10
20/25	BSR 20/25 A22	Pow. Coated	Pastel Grey	21,38	10
20/40	BSR 20/40 A22	Pow. Coated	Pastel Grey	25,97	10
20/60	BSR 20/60 A22	Pow. Coated	Pastel Grey	28,61	10
20/80	BSR 20/80 A22	Pow. Coated	Pastel Grey	32,14	10
20/100	BSR 20/100 A22	Pow. Coated	Pastel Grey	36,58	10

bordertec >> BSRE External Junction in Powder Coated Aluminum

H/H1 mm	Art.	Finish	Variant	€ / pc	pc ■
	BSRE 45 A22	Pow. Coated	Pastel Grey	29,55	10
20/40	BSRE 20/40 A22	Pow. Coated	Pastel Grey	35,92	10
20/60	BSRE 20/60 A22	Pow. Coated	Pastel Grey	39,59	10
20/80	BSRE 20/80 A22	Pow. Coated	Pastel Grey	44,46	10
20/100	BSRE 20/100 A22	Pow. Coated	Pastel Grey	50,57	10

bordertec >> BSRG Joint in Powder Coated Aluminum

H/H1 mm	Art.	Finish	Variant	€ / pc	pc ■
	BSRG 45 A22	Pow. Coated	Pastel Grey	5,88	10
20/40	BSRG 20/40 A22	Pow. Coated	Pastel Grey	7,14	10
20/60	BSRG 20/60 A22	Pow. Coated	Pastel Grey	7,87	10
20/80	BSRG 20/80 A22	Pow. Coated	Pastel Grey	8,84	10
20/100	BSRG 20/100 A22	Pow. Coated	Pastel Grey	10,09	10



bordertec BSR-IL



bordertec BSR-A50 + SUPAS

☒ For quantities below 10 pcs 10% price increase applied.

Length: 2,70 meters

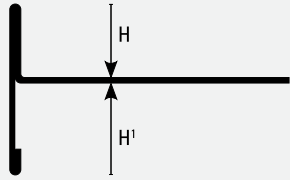

BSR - A



A50

The images are inserted purely for illustrative purposes

bordertec >> BSR in Powder Coated Aluminum Modern Line

H/H1 mm	Art.	Finish	Variant	€ / m	pc ■
10/35	BSR 10/35 A50	Pow. Coated	Embossed Micaceous	21,38	5
15/30	BSR 15/30 A50	Pow. Coated	Embossed Micaceous	21,38	5
20/25	BSR 20/25 A50	Pow. Coated	Embossed Micaceous	21,38	5
20/40	BSR 20/40 A50	Pow. Coated	Embossed Micaceous	25,97	5
20/60	BSR 20/60 A50	Pow. Coated	Embossed Micaceous	28,61	5
20/80	BSR 20/80 A50	Pow. Coated	Embossed Micaceous	32,14	5
20/100	BSR 20/100 A50	Pow. Coated	Embossed Micaceous	36,58	5

Other finishes Modern Line (24/25/60/64) on minimum request of 100 pcs.

bordertec >> BSRE External Junction in Powder Coated Modern Line

H/H1 mm	Art.	Finish	Variant	€ / pc	pc ■
	BSRE 45 A50	Pow. Coated	Embossed Micaceous	29,55	10
20/40	BSRE 20/40 A50	Pow. Coated	Embossed Micaceous	35,92	10
20/60	BSRE 20/60 A50	Pow. Coated	Embossed Micaceous	39,59	10
20/80	BSRE 20/80 A50	Pow. Coated	Embossed Micaceous	44,46	10
20/100	BSRE 20/100 A50	Pow. Coated	Embossed Micaceous	50,57	10

Other finishes Modern Line (24/25/60/64) on minimum request of 100 pcs.

bordertec >> BSRG Joint in Powder Coated Aluminum Modern Line

H/H1 mm	Art.	Finish	Variant	€ / pc	pc ■
	BSRG 45 A50	Pow. Coated	Embossed Micaceous	5,88	10
20/40	BSRG 20/40 A50	Pow. Coated	Embossed Micaceous	7,14	10
20/60	BSRG 20/60 A50	Pow. Coated	Embossed Micaceous	7,87	10
20/80	BSRG 20/80 A50	Pow. Coated	Embossed Micaceous	8,84	10
20/100	BSRG 20/100 A50	Pow. Coated	Embossed Micaceous	10,09	10

Other finishes Modern Line (24/25/60/64) on minimum request of 100 pcs.

+ Perimeter profile for floating floors

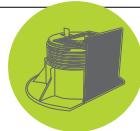

- + Sizes from 20 to 100 mm
- + No special ceramic pieces required
- + Quick anchorage to SUPA* floor supports (see page 166)

uptec >> adjustable universal pedestals for raised floors - components

Art.	Finish	€ / pc	pck ■
SUPAL	Low pedestal	4,20	24 pcs
SUPAS	Standard pedestal	4,39	24 pcs
SUPAR	Modular Ring	0,88	24 pcs

uptec >> accessories

Art.	Finish	€ / pc	pck ■
SUPA2	spacer - 2 mm tabs	1,53	240 pcs
SUPA4	Spacer - 4 mm tabs - also compatible with Al. joists	1,53	240 pcs
SUPAW	spacer - wooden joints	1,53	240 pcs
SUPAR 120	Big ring	2,63	24 pcs
SUPAK	3 functions adjusting key	72,69	1 pc

☒ For quantities below 10 pcs 10% price increase applied.

pkg = indivisible packaging

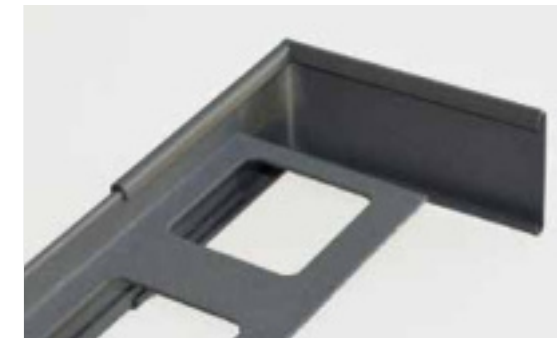

bordertec BSRE-A50

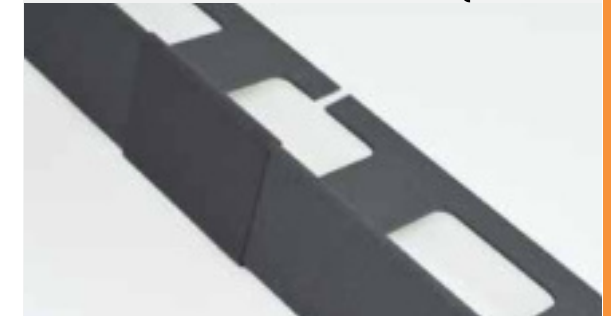

bordertec BSRG-A50



uptec SUPAL



uptec SUPAS



uptec SUPAR



SUPAL



SUPAS



SUPAR

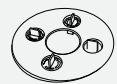

SUPA2



SUPA4



SUPAW



SUPAK



Length: 2,70 meters

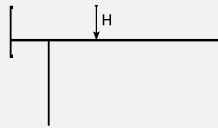

BST20 A*



A24 A33 A50

The images are inserted purely for illustrative purposes

bordertec >> BST in Powder Coated Aluminum Modern Line

	H = mm	Art.			Finish	Variant	€ / m	pc ■
new	20	BST	20	A24	Pow. Coated	Embossed Micaceous	36,14	5
new	20	BST	20	A33	Pow. Coated	Embossed Micaceous	36,14	5
new	20	BST	20	A50	Pow. Coated	Embossed Micaceous	36,14	5

bordertec >> BSTE Joint in Powder Coated Aluminum Modern Line

	H = mm	Art.			Finish	Variant	€ / pc	set ■
new	20	BSTE	20	A24	Pow. Coated	Embossed Micaceous	49,93	10
new	20	BSTE	20	A33	Pow. Coated	Embossed Micaceous	49,93	10
new	20	BSTE	20	A50	Pow. Coated	Embossed Micaceous	49,93	10



bordertec BST 20 A50

✘ For quantities below 10 pcs 10% price increase applied.



Tile installation membranes

Waterproofing, drainage and uncoupling membranes are indispensable for flawless ceramic and stone tile installations. Engineered to perform over challenging substrates. PROFILITEC offers a variety of solutions: A membrane that uncouples the tile layer from the substrate, preventing stress build-up which leads to cracking.

Innovative drainage membranes for outdoor flooring over balconies and terraces to prevent deterioration due to water infiltration and condensation in the mortar bed.

Membranes that meet ANSI 118.10 waterproofing standards, guaranteeing first-rate results in diverse construction applications.

Article	Code	Use	Pag.
Foiltec	Foiltec	waterproofing	144
Floortec	Floortec	uncoupling	146
Draintec	8	drainage-cement screed	147
Draintec	8S	drainage-drainage screed	147
Bandtec	Bandtec	thermoplastic elastomer	148





Membrane roll length:
Foiltec/05/G
B = 1 m
L = 30 m
Total: 30 m²
Foiltec/05/5/G
B = 1 m
L = 5 m
Total: 5 m²
Membrane thickness:
H = 0,5 mm

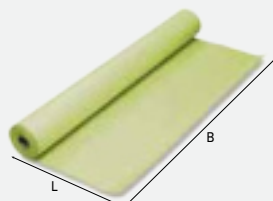

Membrane roll length:
Foiltec/15
B = 0,15 m
L = 30 m
Membrane thickness:
H = 0,4 mm



Only a correct execution of all junctions assures a perfect result.

foiltec water-stop >> Insulating membrane thickness 0.5mm in Polyethylene suitable for tile adhesive

BxL = m	Art.	Finish	Variant	€ / m ²	roll ■	rot/pallet
1 x 30	FOILTEC /05 /G	Polyethylene	in Roll	15,13	1	30
1 x 5	FOILTEC /05/5 /G	Polyethylene	in Roll	17,08	1	30

foiltec water-stop >> Sealing strip for butt joints and perimeter edges

BxL = m	Art.	Finish	Variant	€ / m	roll ■
0,15 x 30	FOILTEC /15	Polyethylene	Sealing strip	3,36	1

foiltec >> External corner water-stop in Polyethylene

Art.	Finish	Variant	€ / set	set ■
FOILTEC /E /G	Polyethylene	External corner	14,37	2

foiltec >> Internal corner water-stop in Polyethylene

Art.	Finish	Variant	€ / pc	set ■
FOILTEC /I /G	Polyethylene	Internal corner	14,37	2

foiltec >> Pipe collar water-stop in Polyethylene

Art.	Finish	Variant	€ / pc	set ■
FOILTEC /T20 /G	Polyethylene	Pipe collar ø 15-20 mm	6,54	1

Water-stop foiltec membrane is made of a polyethylene film 200 µ thick laminated with a synthetic fleece on both sides, for its proper anchoring to ceramic tile adhesive. water-stop foiltec can be used under wall or floor tiling and works not only as waterproofing but also as vapour barrier.

water-stop foiltec system >> Waterproofing system for environments with high humidity

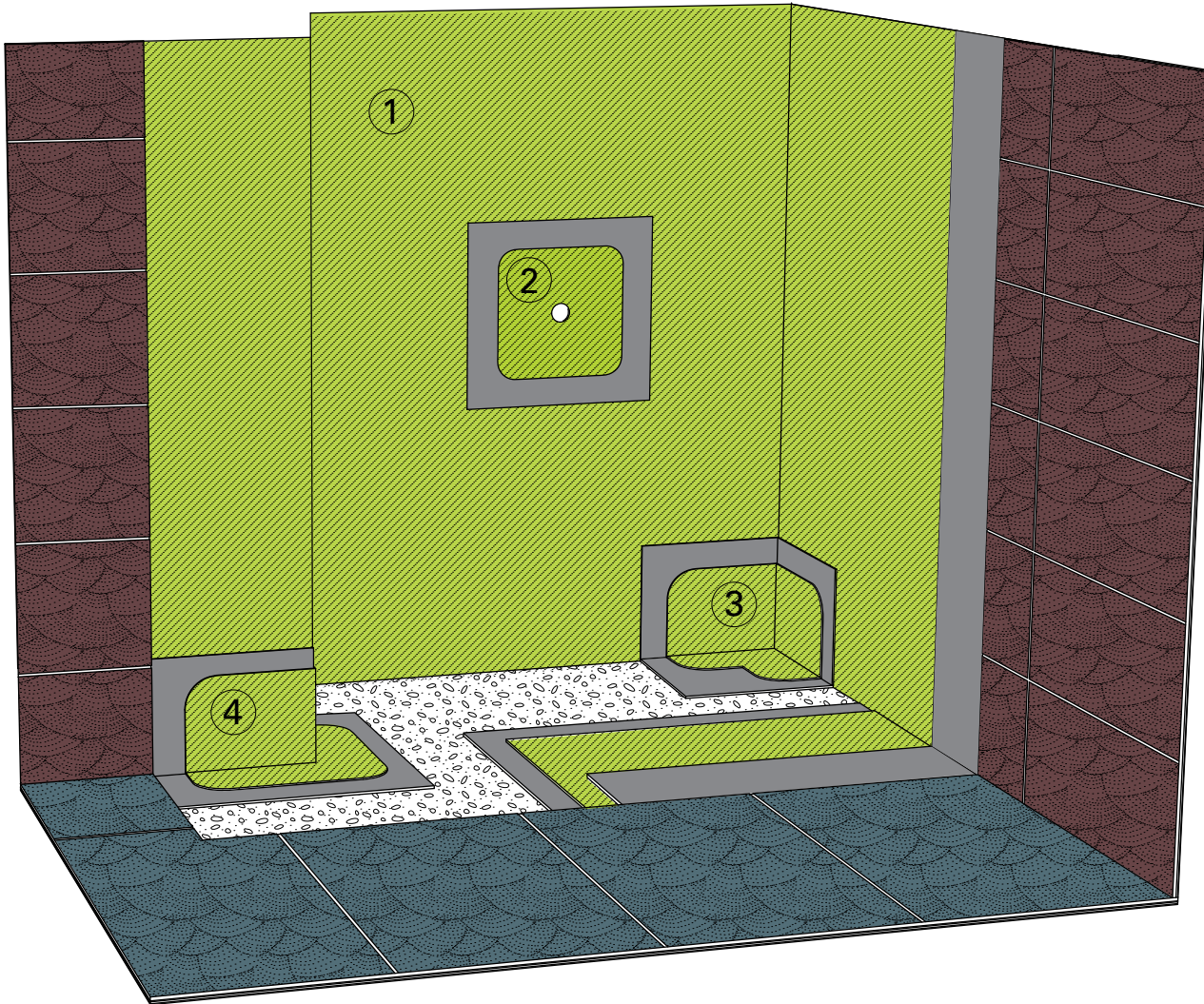

1 - matting foiltec

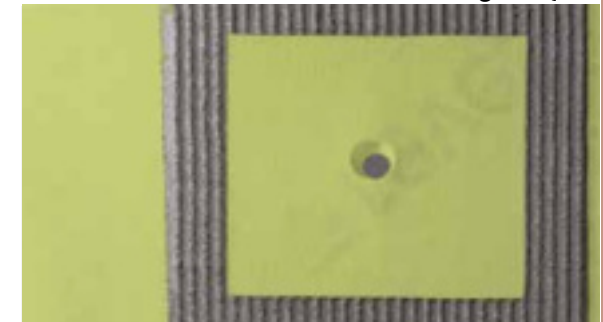

2 - foiltec /T20/ G

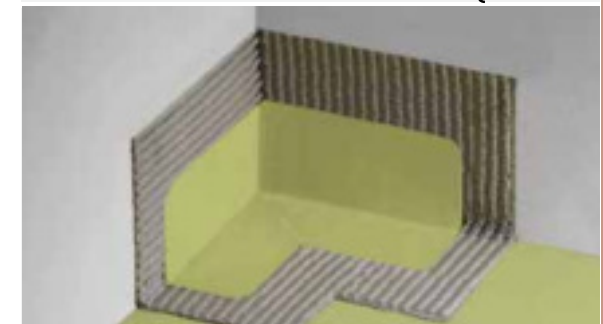

3 - foiltec /I/ G

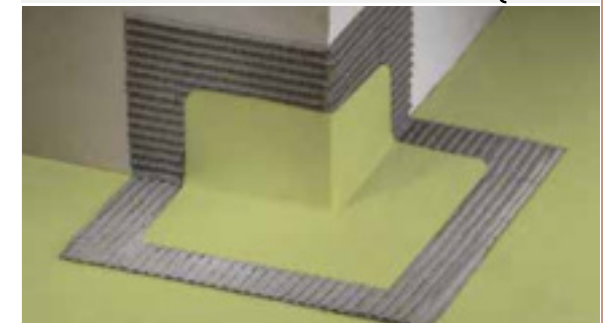

4 - foiltec /E/ G

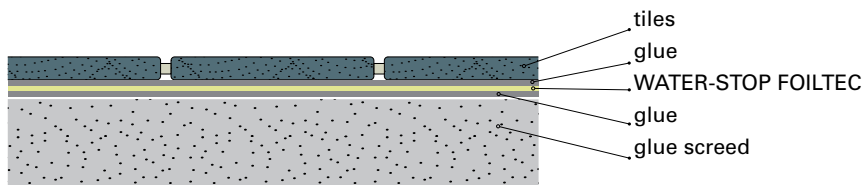



Membrane roll length:

B = 1 m

L = 30 m

Total: 30 m2

The membrane is 3 mm in total thickness and composed of high density polyethylene laminated with Spunbond non-woven fabric on the underside.

floortec >> polyethylene membrane for tile floor

	H = mm	Art.	Finish	€ / sq.m	roll ■	roll/pallet
	3	FLOORTEC	Virgin polyethylene (PE HD)	16,93	1	12

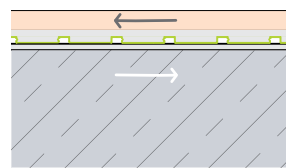
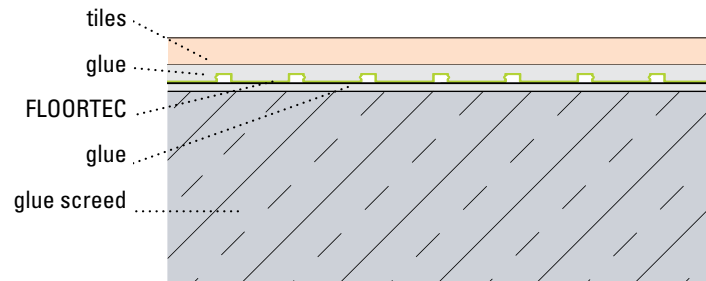

TENSION COMPENSATION (uncoupling characteristic)

The membrane is able to compensate for differential movement in all directions, neutralizing tension between the substrate (concrete or wood structures) and tile, hence preventing stress build-up and damages to the tile layer.

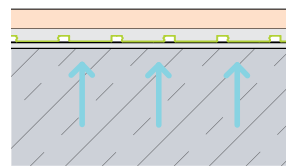

VAPOR MANAGEMENT

The open cavities on the underside of the membrane provide pressure relief for moisture rising from the substrate allowing the tile flooring to be installed without waiting the usual curing time for concrete (28 days). The humidity evaporates through the interstitial spacing between the waterproof membrane and the non-woven fabric.

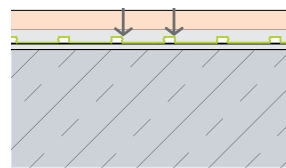

LOAD RESISTANCE

The circular column support structure on the surface of the membrane provides increased load resistance compared to other-shaped columns: the mortar-based adhesive on the surface of the mat fills the circular cavities forming a solid column support structure. FLOORTEC has been tested by TCNA and passed all 14 cycles (Extra-Heavy Commercial) on the Robinson Wheel Test (ASTM C627) over 19.2" wood frame construction.

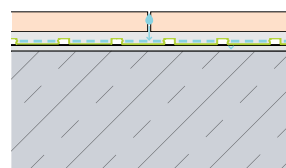

WATERPROOFING*

The membrane material, HDPE (high density polyethylene), is waterproof. The top layer of the membrane blocks water infiltration, facilitating the natural water evaporation process. The mortar bed is therefore protected from water percolation and not subjected to damage due to ice formation caused by low temperatures during the winter months.

* PLEASE NOTE :The Floortec membrane is composed of a plastic material resistant to water, but the complete waterproofing of the application must be carried out by using Foiltec strips and corner joints. The incorrect application of these accessories may compromise waterproofing. Additionally, please note that the FLOORTEC membrane cannot be used as a primary waterproofing system, for which a bituminous membrane or similar product must be used.

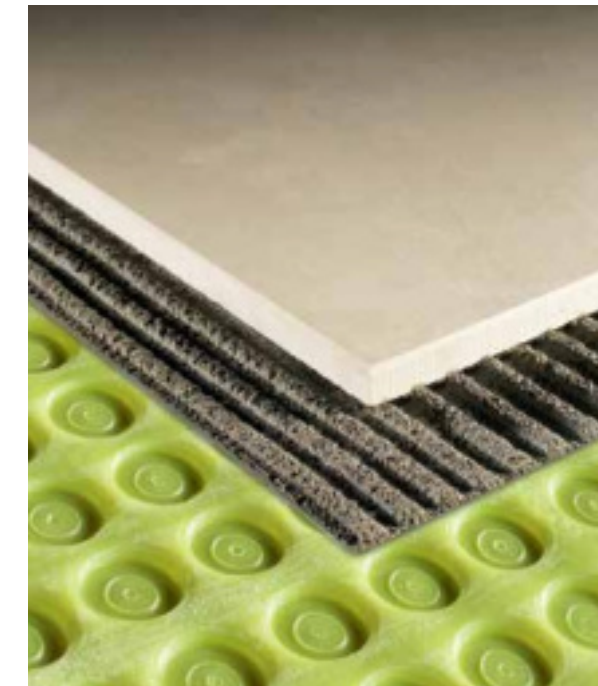

floor+tec



floor+tec roll



Membrane roll length:

W = 1 m
L = 15 m
Total: 15m²

draintec 8 >> Polyethylene drainage membrane with a pyramid section with a synthetic filtering fleece

H = mm	Art.	Finish	€ / sq.m	roll ■
8	DRAINTEC 8	Polyethylene	12,34	1

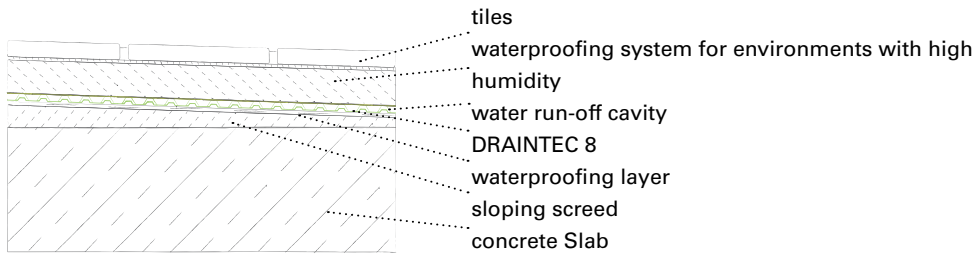

drain+tec 8

Membrane roll length:

W = 1 m
L = 12,5 m
Total: 12.5m²

draintec 8S >> Drainage membrane with knobs and filter fabric for dry laying

H = mm	Art.	Finish	€ / sq.m	roll ■
8	DRAINTEC 8 S	Polyethylene	13,90	1

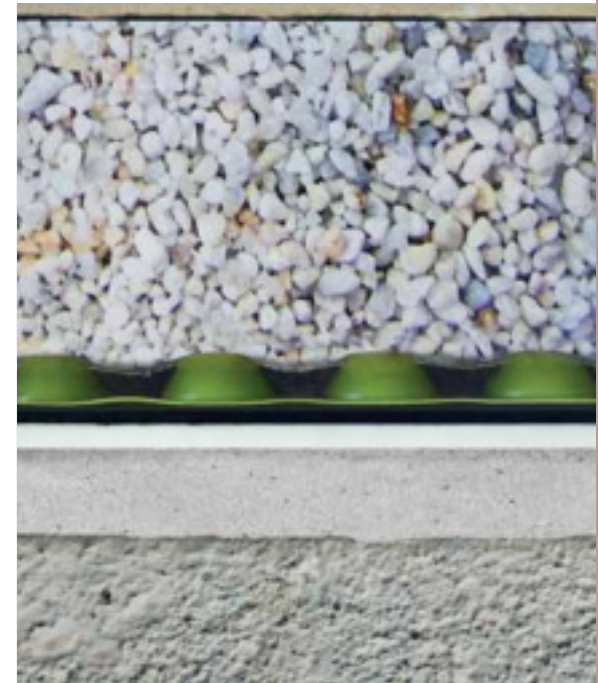
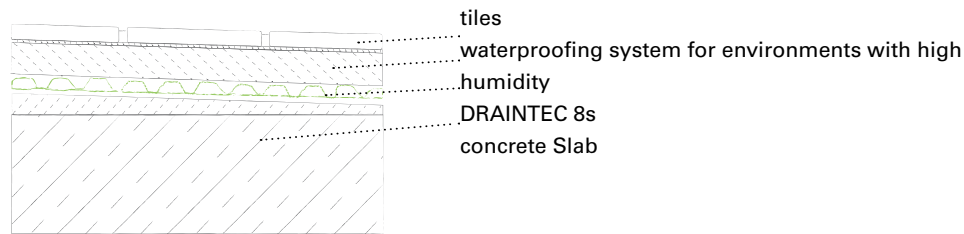

drain+tec 8s

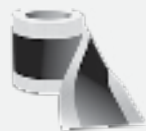

BANDTEC/12



BANDTEC/E



BANDTEC/I



BANDTEC/T

bandtec >> Thermoplastic waterproofing elastomer

HxL mm	Art.	Finish	€ / m	roll ■
0,12 x 50	BANDTEC /12	Thermoplastic elastomer	3,94	1

bandtec >> Internal corner in Thermoplastic waterproofing elastomer

	Art.	Finish	€ / pc	set ■
	BANDTEC /I	Thermoplastic elastomer	8,87	10

bandtec >> External corner in Thermoplastic waterproofing elastomer

	Art.	Finish	€ / pc	set ■
	BANDTEC /E	Thermoplastic elastomer	8,87	10

bandtec >> Joints for pipes in Thermoplastic waterproofing elastomer

B = mm	Art.	Finish	€ / pc	set ■
0,12	BANDTEC /T	Thermoplastic elastomer	6,13	10



band+tec 12



Baseboards

A complete range of wood, plastic, steel or aluminum baseboards to meet all technical and aesthetic needs. The aluminum baseboards are not only suitable for prestigious settings, they are also durable over time. In addition, many of the profiles contain an internal cavity which acts as a channel for cables and wiring.

The innovative, “two-tone” baseboards are composed of elements which can be combined in endless ways to match with any material in the room.

As an alternative to common baseboards, Profilitec has also created the “Plano” line, which integrates the profile into drywall, directly inserting the baseboard into the wall and creating a seamless, smooth vertical surface.

The Plano line is composed of external elements in aluminum, or internal profiles that attach to the drywall and hold a baseboard strip in the same material as the flooring.

Article	Code	Use	Pag.
Baseboard	BA	standard decorative	150
Baseboard	BAR	standard decorative	153
Baseboard	BA700	standard decorative - PVC	153
Baseboard	BA400	minimal interlocking	154
Baseboard	BAS800	minimal interlocking	154
Baseboard	BI	minimal interlocking	155
Baseboard	BIB	bicolor	155
Baseboard	BIM	bicolor	156
Baseboard	BT	bicolor	156
Plano	BF	plano design	157
Plano	PS	plano design	157
Baseboard	BFW	plano design	158
Baseboard	BFZ	structural/construction	158
Sanitec	IC	plano design	159
Wallprotection	WB	baseboard in Resina	159





Length: 2,70 meters

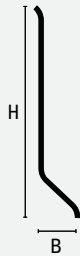

BA - I

B = 10 mm



IL IS IX

The images are inserted purely for illustrative purposes



BAE

BAI



BAT

baseboard >> BA in Stainless Steel AISI 304 - DIN. 1.4301 - Polished - Self-Adhesive

H = mm	Art.	Finish	Variant	€ / m	pc ■
60	BA 600 ILN	Polished	not Adhesive	13,20	20
80	BA 800 ILN	Polished	not Adhesive	18,00	20

baseboard >> BA in Stainless Steel AISI 304 - DIN. 1.4301 - Polished - with no adhesive

H = mm	Art.	Finish	Variant	€ / m	pc ■
60	BA 600 ILN	Polished	not Adhesive	13,20	20
80	BA 800 ILN	Polished	not Adhesive	18,00	20

baseboard >> BAE-PI Internal Junction in plastic Stainless Steel Color

H = mm	Art.	Finish	Variant	€ / pc	pc ■
60	BAE 600 PI	Plastic	Inox look	5,22	1
80	BAE 800 PI	Plastic	Inox look	5,22	1

baseboard >> BAI-PI External Junction in plastic Stainless Steel Color

H = mm	Art.	Finish	Variant	€ / pc	pc ■
60	BAI 600 PI	Plastic	Inox look	5,22	1
80	BAI 800 PI	Plastic	Inox look	5,22	1

baseboard >> BAT-PI End-caps in plastic Stainless Steel Color

H = mm	Art.	Finish	Variant	€ / pc	pc ■
60	BAT 600 PI	Plastic	Inox look	10,43	2
80	BAT 800 PI	Plastic	Inox look	10,43	2

BAT - / 1 set = 1Right 1Left

baseboard >> BA in Stainless Steel AISI 304 - DIN. 1.4301 - Brushed - Self-Adhesive

H = mm	Art.	Finish	Variant	€ / m	pc ■
60	BA 600 ISA	Brushed	Self-Adhesive	18,27	10 ☞
80	BA 800 ISA	Brushed	Self-Adhesive	23,11	10 ☞

baseboard >> BA in Stainless Steel AISI 304 - DIN. 1.4301 - Brushed - with no adhesive

H = mm	Art.	Finish	Variant	€ / m	pc ■
60	BA 600 ISN	Brushed	not Adhesive	16,17	20
80	BA 800 ISN	Brushed	not Adhesive	20,97	20

baseboard >> BA in Stainless Steel AISI 304 - DIN. 1.4301 - Sanded

H = mm	Art.	Finish	€ / m	pc ■
60	BA 600 IX	Sanded	16,88	20



baseboard BA-IL

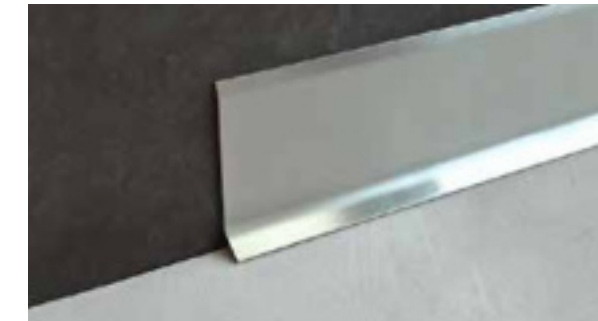

baseboard BA 600 ISN



baseboard BA 600 IX

☒ For quantities below 20 pcs 10% price increase applied.



Length: 2,70 meters

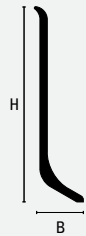

BA - A

B = 10 mm

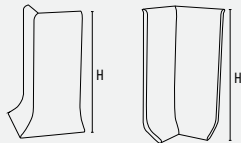

BAE-A
BAI-A

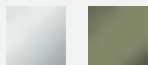

AS AT

The images are inserted purely for illustrative purposes

baseboard >> BA in Anodized Aluminum - Self-Adhesive

H = mm	Art.	Finish	Variant	€/ m	pc ■
45	BA 450 ASA	Anodized	Silver Self-Adhesive	8,88	20
60	BA 600 ASA	Anodized	Silver Self-Adhesive	10,60	20
80	BA 800 ASA	Anodized	Silver Self-Adhesive	13,04	15
100	BA 1000 ASA	Anodized	Silver Self-Adhesive	16,72	15

baseboard >> BA in Anodized Aluminum - with no adhesive

H = mm	Art.	Finish	Variant	€/ m	pc ■
45	BA 450 ASN	Anodized	Silver - not Self-Adhesive	6,95	20
60	BA 600 ASN	Anodized	Silver - not Self-Adhesive	8,64	20
80	BA 800 ASN	Anodized	Silver - not Self-Adhesive	11,03	15
100	BA 1000 ASN	Anodized	Silver - not Self-Adhesive	14,73	15

baseboard >> BA in Anodized Aluminum

H = mm	Art.	Finish	Variant	€/ m	pc ■
60	BA 600 AT	Anodized	Titan	12,82	20

baseboard >> BAE External corner in Anodized Aluminum

H = mm	Art.	Finish	Variant	€/ set	set ■
45	BAE 450 AS	Anodized	Silver	38,51	2 pcs
60	BAE 600 AS	Anodized	Silver	40,61	2 pcs
80	BAE 800 AS	Anodized	Silver	42,69	2 pcs
100	BAE 1000 AS	Anodized	Silver	44,75	2 pcs
60	BAE 600 AT	Anodized	Titan	49,98	2 pcs

baseboard >> BAI Internal corner in Anodized Aluminum

H = mm	Art.	Finish	Variant	€/ set	set ■
45	BAI 450 AS	Anodized	Silver	38,51	2 pcs
60	BAI 600 AS	Anodized	Silver	40,61	2 pcs
80	BAI 800 AS	Anodized	Silver	42,69	2 pcs
100	BAI 1000 AS	Anodized	Silver	44,75	2 pcs
60	BAI 600 AT	Anodized	Titan	49,98	2 pcs

baseboard >> BAE External corner in Plastic

H = mm	Art.	Finish	Variant	€/ set	set ■
60	BAE 600 PS	Plastic	Silver	3,52	1
80	BAE 800 PS	Plastic	Silver	3,52	1

baseboard >> BAI Internal corner in Plastic

H = mm	Art.	Finish	Variant	€/ set	set ■
60	BAI 600 PS	Plastic	Silver	3,52	1
80	BAI 800 PS	Plastic	Silver	3,52	1

baseboard >> BAT End cap in Plastic

H = mm	Art.	Finish	Variant	€/ set	set ■
60	BAT 600 PS	Plastic	Silver	7,07	2
80	BAT 800 PS	Plastic	Silver	7,07	2

BAT - / 1 set = 1Right 1Left

For quantities below 20 pcs 10% price increase applied.

Individually wrapped



baseboard BA-AS



baseboard BA-AT

standard decorative

baseboard



Length: 2,70 meters

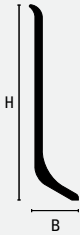

BA - A

B = 10 mm

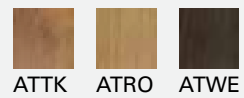
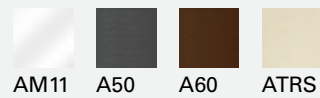

The images are inserted purely for illustrative purposes

baseboard >> BA in Powder Coated Aluminum

H = mm	Art.	Finish	Variant	€ / m	pc ■
60	BA 600 AM11	Pow. Coated	Matt White	9,67	20

baseboard >> BAE External corner in Powder Coated Aluminum

H = mm	Art.	Finish	Variant	€ / set	set ■
60	BAE 600 AM11	Pow. Coated	Matt White	44,67	2 pcs

baseboard >> BAI Internal corner in Powder Coated Aluminum

H = mm	Art.	Finish	Variant	€ / set	set ■
60	BAI 600 AM11	Pow. Coated	Matt White	44,67	2 pcs

baseboard >> BA in Powder Coated Aluminum Modern Line

H = mm	Art.	Finish	Variant	€ / m	pc ■
60	BA 600 A50	Pow. Coated	Embossed Micaceous	12,82	20
60	BA 600 A60	Pow. Coated	Embossed Corten	12,82	20

baseboard >> BAE External corner in Powder Coated Aluminum Modern Line

H = mm	Art.	Finish	Variant	€ / set	set ■
60	BAE 600 A50	Pow. Coated	Embossed Micaceous	44,67	2 pcs
60	BAE 600 A60	Pow. Coated	Embossed Corten	44,67	2 pcs

baseboard >> BAI Internal corner in Powder Coated Aluminum Modern Line

H = mm	Art.	Finish	Variant	€ / set	set ■
60	BAI 600 A50	Pow. Coated	Embossed Micaceous	44,67	2 pcs
60	BAI 600 A60	Pow. Coated	Embossed Corten	44,67	2 pcs

baseboard >> BA in High Resistance Wood Laminated Aluminum

H = mm	Art.	Finish	Variant	€ / m	pc ■
60	BA 600 ATRSN	Wood effect	Texture Bleached	12,82	20
60	BA 600 ATWEN	Wood effect	Texture Wengè	12,82	20
60	BA 600 ATTKN	Wood effect	Texture Teak	12,82	20
60	BA 600 ATRON	Wood effect	Texture Oak	12,82	20



baseboard BA 600 ATRS



baseboard BA-ATRON

✘ For quantities below 20 pcs 10% price increase applied



Length: 2,70 meters

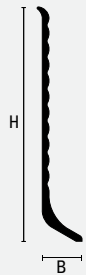

BAR 600 A

B = 10 mm



AS

baseboard >> BAR Multiline in Anodized Aluminum - Self-Adhesive

H = mm	Art.			Finish	Variant	€ / m	pc ■
60	BAR	600	ASA	Anodized	Silver Self-Adhesive	12,17	20

baseboard >> BAR 600 ASN Multiline Ribbed Anodized Aluminum - not Adhesive

H = mm	Art.			Finish	Variant	€ / m	pc ■
60	BAR	600	ASN	Anodized	Silver - not Self-Adhesive	10,18	20

baseboard >> BAE External corner in Plastic

H = mm	Art.			Finish	€ / set	set ■
60	BAE	600	PS	Plastic	3,52	1

baseboard >> BAI Internal corner in Plastic

H = mm	Art.			Finish	€ / set	set ■
60	BAI	600	PS	Plastic	3,52	1

baseboard >> BAT End cap in Plastic

H = mm	Art.			Finish	€ / set	set ■
60	BAT	600	PS	Plastic	7,07	2

Set = 1dx + 1sx.



baseboard BAR 600 ASN



baseboard BAR 600 ASA

Length: 2,00 m

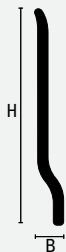

BA 700 P

B = 10 mm

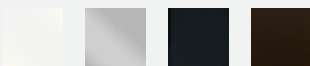

P12 P22 P51 P79

baseboard >> BA700 in Expanded PVC

H = mm	Art.			Finish	Variant	€ / m	pc ■
70	BA	700	P12	PVC	White	4,18	100
70	BA	700	P22	PVC	Pastel Grey	4,18	100
70	BA	700	P51	PVC	Black	4,18	100
70	BA	700	P79	PVC	Walnut	4,18	100

Sold in full box. Loose pcs not available.

*The extrusion process for skirting boards is different from the process used for profiles. The color correspondence reported at the end of this present price list, which refers to profiles, cannot be guaranteed.



baseboard BA 700 P79

For quantities below 20 pcs 10% price increase applied.
 Individually wrapped



Length: 2,70 meters



BA 400 A

B = 10 mm



AS ASS ASB A11



A50 A60

The images are inserted purely for illustrative purposes



BAC 400



BAS 800 A

B = 10 mm

minimal interlocking

baseboard

baseboard >> BA400 in Anodized Aluminum

H = mm	Art.	Finish	Variant	€ / m	pc ■
40	BA 400 ASN	Anodized	Silver	9,89	20
40	BA 400 ASS	Brushed Anodized	Silver	11,13	20

baseboard >> BAC400 Universal end caps in Anodized Aluminum

H = mm	Art.	Finish	Variant	€ / set	pc ■
40	BAC 400 AS	Anodized	Silver	9,24	1 pc
40	BAC 400 ASS	Brushed Anodized	Silver	9,24	1 pc

baseboard >> BA400 in Bright Polished Anodized Aluminum

H = mm	Art.	Finish	Variant	€ / m	pc ■
40	BA 400 ASB	Bright Polished Anodized	Chrome	12,27	20

baseboard >> BAC400 Universal end caps in Bright Polished Anodized Aluminum

H = mm	Art.	Finish	Variant	€ / set	pc ■
40	BAC 400 ASB	Bright Polished Anodized	Chrome	9,24	1 pc

baseboard >> BA400 in Powder Coated Aluminum

H = mm	Art.	Finish	Variant	€ / m	pc ■
40	BA 400 AM11	Pow. Coated	Matt White	9,67	20

baseboard >> BAC400 Universal end caps in Powder Coated Aluminum

H = mm	Art.	Finish	Variant	€ / set	pc ■
40	BAC 400 AM11	Pow. Coated	Matt White	9,24	1 pc

baseboard >> BA400 in Powder Coated Aluminum Modern Line

H = mm	Art.	Finish	Variant	€ / m	pc ■
40	BA 400 A50	Pow. Coated	Embossed Micaceous	14,06	20
40	BA 400 A60	Pow. Coated	Embossed Corten	14,06	20

baseboard >> BAC400 Universal end caps in Powder Coated Aluminum Modern Line

H = mm	Art.	Finish	Variant	€ / set	pc ■
40	BAC 400 A50	Pow. Coated	Embossed Micaceous	9,24	1 pc
40	BAC 400 A60	Pow. Coated	Embossed Corten	9,24	1 pc

baseboard >> BAS800 in Brushed Anodized Aluminum

H = mm	Art.	Finish	Variant	€ / m	pc ■
80	BAS 800 ASS	Brushed Anodized	Silver	27,71	10

baseboard >> BAC800 Universal end caps in Brushed Anodized Aluminum

H = mm	Art.	Finish	Variant	€ / set	pc ■
80	BAC 800 ASS	Brushed Anodized	Silver	22,24	1 pc



baseboard BA 400 AS



baseboard BA 400 AM11



baseboard BAS 800 ASS

For quantities below 20 pcs 10% price increase applied.

Individually wrapped



Length: 2,70 meters

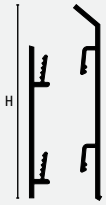

SUPPORT: BIS 20 ANF
+ TOP: BI - ASN



AN AS

The images are inserted purely for illustrative purposes



BIE BII BIT

baseboard >> BIS Support in Anodized Aluminum - Drilled

Art.	Finish	Variant	€ / pc	set ■
BIS 20 ANF	Natural	Drilled	0,40	10 pcs

Supports have to be ordered separately, suggested from 2 to 3 pcs/m.

baseboard >> BI - TOP Interlocking pieces in Anodized Aluminum

H = mm	Art.	Finish	Variant	€ / m	pc ■
70	BI 700 ASN	Anodized	Silver	10,04	15
100	BI 1000 ASN	Anodized	Silver	14,32	15

baseboard >> BII Internal corner in Plastic

Art.	Finish	€ / pc	pc ■
BII 700 PS	Plastic	3,63	1 pc

Supports have to be ordered separately, suggested from 2 to 3 pcs/m.

baseboard >> BIE External corner in Plastic

Art.	Finish	€ / pc	pc ■
BIE 700 PS	Plastic	3,63	1 pc

Supports have to be ordered separately, suggested from 2 to 3 pcs/m.

baseboard >> BIT End cap in Plastic

Art.	Finish	€ / pc	set ■
BIT 700 PS	Plastic	3,63	2 pcs

Supports have to be ordered separately, suggested from 2 to 3 pcs/m.



baseboard BIS + BI 700

Length: 2,70 meters

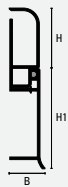

BASE: BIB 800 ASN
+ TOP: BI 800
B= 17,5 mm

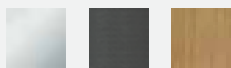

AS A50 RO

The images are inserted purely for illustrative purposes

baseboard >> BIB - BASE Interlocking pieces in Anodized Aluminum combinable with the "TOP" mentioned in the tables below

H1 = mm	Art.	Finish	Variant	€ / m	pc ■
50	BIB 800 ASN	Anodized	BASE Silver	12,00	10

baseboard >> BI - TOP Interlocking pieces in Anodized Aluminum

H = mm	Art.	Finish	Variant	€ / m	pc ■
30	BI 800 ASN	Anodized	TOP Silver	6,79	10

baseboard >> BI - TOP Interlocking pieces in Powder Coated Aluminum Modern Line

H = mm	Art.	Finish	Variant	€ / m	pc ■
30	BI 800 A50	Pow. Coated	TOP Micaceous Grey	8,35	10

baseboard >> BI - TOP Interlocking pieces in Wood "BiColor" effect

H = mm	Art.	Finish	Variant	€ / m	pc ■
30	BI 800 RO	Wood gloss painted	TOP Polished Oak	13,30	10
30	BI 800 RON	Wood	TOP Natural Oak	12,25	10



baseboard BIB + BI 800

For quantities below 20 pcs 10% price increase applied.

Individually wrapped

minimal interlocking

baseboard



Length: 2,70 meters

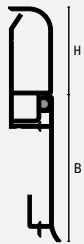

BASE: BIM 800 ASN
+ TOP: BI 800 A

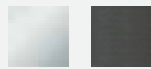

AS A50

The images are inserted purely for illustrative purposes



BIE BII BIT

baseboard >> BIM - BASE Interlocking baseboard which covers the waterproof layer in Anodized Aluminum combinable with the "TOP" in the tables below

B = mm	Art.	Finish	Variant	€ / m	pc ■
50	BIM 800 ASN	Anodized	BASE Silver	12,00	10

baseboard >> BI - TOP Interlocking pieces in Anodized Aluminum

H = mm	Art.	Finish	Variant	€ / m	pc ■
30	BI 800 ASN	Anodized	TOP Silver	6,79	10

baseboard >> BI - TOP Interlocking pieces in Powder Coated Aluminum Modern Line

H = mm	Art.	Finish	Variant	€ / m	pc ■
30	BI 800 A50	Pow. Coated	TOP Micaceous Grey	8,35	10

baseboard >> BIE External corner in Plastic

H = mm	Art.	Finish	€ / pc	pc ■
30	BIE 800 PS	Plastic	3,52	1

baseboard >> BII Internal corner in Plastic

H = mm	Art.	Finish	€ / pc	pc ■
30	BII 800 PS	Plastic	3,52	1

baseboard >> BIT End cap in Plastic

H = mm	Art.	Finish	€ / pc	set ■
30	BIT 800 PS	Plastic	3,52	2

Set = 1dx + 1sx.



baseboard BIM + BI

Length: 2,70 meters

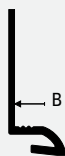

BT 45 A



AS ASB

The images are inserted purely for illustrative purposes

baseboard >> BT in Anodized Aluminum for ultra thin tiles

B = mm	Art.	Finish	Variant	€ / m	pc ■
4,5	BT 45 AS	Anodized	Silver	7,64	40

baseboard >> BT in Bright Polished Alluminum for ultra thin tiles

B = mm	Art.	Finish	Variant	€ / m	pc ■
4,5	BT 45 ASB	Bright Polished Anodized	Chrome	12,52	40



baseboard BT

✘ For quantities below 20 pcs 10% price increase applied.

Individually wrapped



Length: 2,70 meters

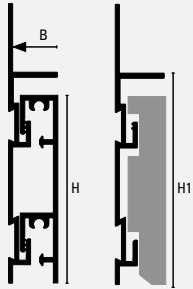

BASE: BF 600 ASN
+ TOP: BF 550
B = 13 mm

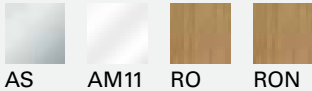

The images are inserted purely for illustrative purposes



BFC AM11

plano >> BF - BASE in Anodized Aluminum - Plano Design for Drywall at the wall level

H1 = mm	Art.	Finish	Variant	€ / m	pc ■
60	BF 600 ASN	Anodized	Silver	12,52	20

plano >> BF - TOP in Anodized Aluminum for BF 600

H = mm	Art.	Finish	Variant	€ / m	set ■
55	BF 550 ASN	Anodized	TOP Silver	11,11	20

plano >> BF - TOP in Powder Coated Aluminum for BF 600

H = mm	Art.	Finish	Variant	€ / m	set ■
55	BF 550 AM11	Pow. Coated	TOP Matt White	12,77	20

plano >> BF - TOP in Natural Oak for BF 600

H = mm	Art.	Finish	Variant	€ / m	set ■
55	BF 550 RON	Wood	TOP Natural Oak	16,83	20
55	BF 550 RO	Wood gloss painted	TOP Polished Oak	18,10	20

plano >> BFC Junction in Anodized Aluminum for baseboard Plano Design

Art.	Finish	Variant	€ / pc	pc ■
BFC 550 AS	Anodized	Silver	8,87	1

plano >> BFC Junction in Powder Coated Aluminum for baseboard Plano Design

Art.	Finish	Variant	€ / pc	pc ■
BFC 550 AM11	Pow. Coated	Matt White	8,87	1



plano BF

Length: 2,70 meters

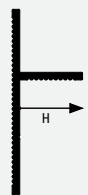

PS 130 AS



AS

The images are inserted purely for illustrative purposes

plano >> PS Profile for Drywell in Anodized Aluminum

H = mm	Art.	Finish	Variant	€ / m	pc ■
13	PS 130 AS	Anodized	Silver	5,64	10



plano PS 130 AS

For quantities below 20 pcs 10% price increase applied.
 Individually wrapped



Length: 2,70 meters

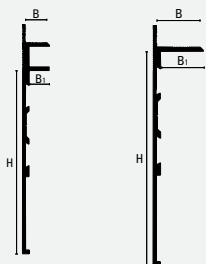

BFW 1000/130 AN BFW 1000/220 AN

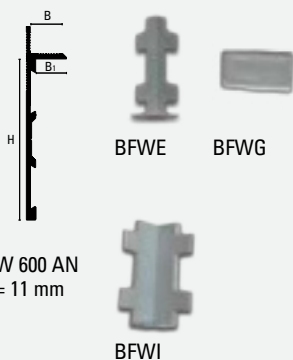

BFW 600 AN
B1= 11 mm

plano >> BFW in Aluminum wall integrated support to install tile or wood baseboard

HxB mm	Art.	Finish	€ / m	pc ■
60 x 13,5	BFW 600 AN	Natural	10,30	20
100 x 13	BFW 1000/130 AN	Natural	22,86	20
100 x 22	BFW 1000/220 AN	Natural	17,87	20

plano >> BFWI Internal corner in Plastic for BFW

Art.	Finish	€ / set	set ■
BFWI 600 P	Plastic	10,41	5 pcs

Loose pcs not available.

plano >> BFWE External corner in Plastic for BFW

Art.	Finish	€ / set	set ■
BFWE 600 P	Plastic	10,41	5 pcs

Loose pcs not available.

plano >> BFWG Junction in Plastic for BFW

Art.	Finish	€ / set	set ■
BFWG 600 P	Plastic	3,41	10 pcs

Loose pcs not available.



baseboard BFW 600 AN

Length: 2,70 meters

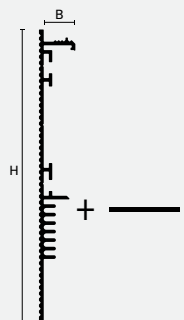

BFZ 1000/130 AN + PP12X2AN

PP12X2AN included in the packaging

plano >> BFZ in Aluminum for construction

HxB mm	Art.	Finish	€ / m	pc ■
120 x 12,5	BFZ 1000/130 AN	Natural	32,73	10



baseboard BFZ 1000/130 AN

⊗ For quantities below 20 pcs 10% price increase applied.



Length: 2,70 meters

sanitec >> IC60 in Synthetic Resin Full body Colored Resintop

BxH mm	Art.	Finish	Variant	€ / m	pc ■
20 x 60	IC 60 P11	Synthetic Resin	Pure White	6,65	40

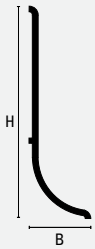

IC 60 P
B = 20 mm



P11
The images are inserted purely for illustrative purposes



sanitec IC 60 P11

Length: 2,70 meters

wallprotection >> WB in Synthetic Resin Full body Colored Resintop

H = mm	Art.	Finish	Variant	€ / m	pc ■
100	WB 100 P11/22	Synthetic Resin	White/Pastel Grey	8,15	20
100	WB 100 P11/11	Synthetic Resin	White/Pure White	8,15	20
100	WB 100 P22/22	Synthetic Resin	Grey/Pastel Grey	8,15	20

It can be welded on a PVC floor with a specific cold prepared adhesive.



WB 100 P
B = 15,8 mm



P11 P22
The images are inserted purely for illustrative purposes



wallprotection WB 100 P11/P22

☒ For quantities below 20 pcs 10% price increase applied.





Drainage systems

Water drainage in indoor and outdoor environments is key in the design and life of a building, combining both technical and aesthetic considerations.

Showertec Linear is a modular shower system that brings together different elements so as to create the best solution for any type of tiled, floor-level shower. This range eliminates the last barrier of the modern bathroom: freeing the bathroom area from standard concepts and dimensions and giving way to endless aesthetic possibilities before unimaginable. A series of sunken channels with horizontal or vertical drainage, including covers and frames in a variety of finishes, materials, shapes, colors and combinations, in addition to a series of pre-sloped trays ready to be tiled, allow the customer to realize projects that link high level functionality and leading edge design.

The range of sloped shower profiles is conceived to provide an incredible attention to detail to the shower area, completing the Showertec Linear system. Profiles in different shapes, finishes and functions guarantee the perfect elements with which to finish the shower space.

The Copridrain line contains a drain system ideal for public areas such as bathrooms, showers or spas. The

line is particularly recommended for outdoor spaces. Copridrain is square and essential, aesthetically appropriate for any setting.

Multidrain is a system of tileable and modular channels for outdoor use. This range contains presloped

elements which can be easily combined for perfect water drainage. It is ideal for outdoor spaces like pools, spas and public showers.

Article	Code	Use	Pag.
showertec linear	STL	drainage channel	162
Copridrain	PD	cockpit	174
Square drain	SDS	square drain	174
Shower profile	KV	Profile Drain	175
Conical profile	KPV	Profile Drain	175
Conical profile	KP	Profile Drain	175
Conical profile	KR	Profile Drain	175
Front end profile	KF	Profile Drain	175
Multidrain	MUD	modular drainage	176
Multidrain	MUDR	reduced modular drainage	176





3
FRAME
(optional)

STL - F Frame	STL - FW Wall frame	DOUBLE EFFECT Combinable finishes

2
COVER

FRAMELESS Without frame	INVISIBLE Tileable cover	TREND FINISHES Wide range

1
DRAIN

STL - BS Drain Standard - H 73 mm	STL - BL Drain Low - H 56 mm	STL - BV Drain Vertical - H 15 mm

Waterproof Pre-sloped tray(2%)

4
TRAY
(optional)

STL-TRAY132/112 + STL-EXT132/56 STL-TRAY132/112 + STL-RAMP132/30

STL - TRAY Tray	STL - EXT Extension	STL - RAMP Ramp

Waterproof Pre-sloped tray(2%) with riser panel

4a
TRAY
+
RISER
(optional)

STL-TRAY132/112R + STL-EXT132/56R

STL - TRAY R Tray with riser panel	STL - EXT R Extension with riser panel



shower+tec linear



shower+tec linear STL-C AGRS



Channel with drain pipe and horizontal drain

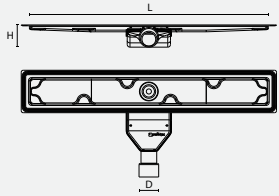

STL-DRAIN LOW H = 56 mm

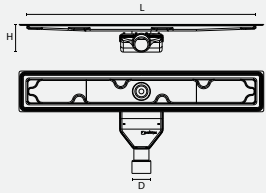

STL-DRAIN STANDARD H = 73 mm

The channel body has a waterproof, pre-installed Foiltec membrane on the flange and is composed of a drain pipe in PP \varnothing 40/50 and support blocks in EPS.

Vertical drain channel

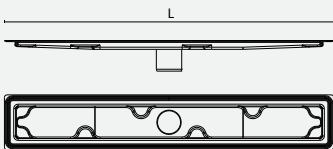

STL-DRAIN VERTICAL

The channel body has a waterproof, pre-installed Foiltec membrane on the flange, a vertical drain \varnothing 50 and support blocks in EPS.

showertec linear >> DRAIN LOW - Channel body with horizontal drain in 316 Stainless Steel - DIN 1.4404

L = mm	Art.	Finish	€ / pc	pc ■
600	STL- BL 600	Reduced height drain body	247,53	1
700	STL- BL 700	Reduced height drain body	257,63	1
800	STL- BL 800	Reduced height drain body	267,72	1
900	STL- BL 900	Reduced height drain body	277,01	1
1000	STL- BL 1000	Reduced height drain body	286,68	1
1200	STL- BL 1200	Reduced height drain body	300,55	1

Installation height 56 mm for traditional installations with sloped mortar bed, not compatible with pre-sloped Linear Showertec TRAY at pag. 168

showertec linear >> DRAIN STANDARD - Shower channel base body with horizontal drain in Stainless Steel 316 - DIN 1.4404

L = mm	Art.	Finish	€ / pc	pc ■
600	STL- BS 600	Standard height drain body	247,53	1
700	STL- BS 700	Standard height drain body	257,63	1
800	STL- BS 800	Standard height drain body	267,72	1
900	STL- BS 900	Standard height drain body	277,01	1
1000	STL- BS 1000	Standard height drain body	286,68	1
1200	STL- BS 1200	Standard height drain body	300,55	1

Installation height 73 mm and can be use in combination with pre-sloped Linear Showertec TRAY at pag. 168

showertec linear >> DRAIN VERTICAL - Shower channel base body with vertical drain in Stainless Steel 316 - DIN 1.4404

L = mm	Art.	Finish	€ / pc	pc ■
600	STL- BV 600	Channel body with vertical drain	216,49	1
700	STL- BV 700	Channel body with vertical drain	227,36	1
800	STL- BV 800	Channel body with vertical drain	236,63	1
900	STL- BV 900	Channel body with vertical drain	248,37	1
1000	STL- BV 1000	Channel body with vertical drain	258,75	1
1200	STL- BV 1200	Channel body with vertical drain	281,65	1

Shower channel can be use in combination with pre-sloped Linear Showertec TRAY, see pag. 168



Showertec Linear

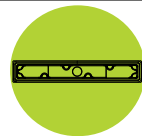

- + Low channel (56 mm) ideal for renovations
- + Channel (73 mm) may be installed with the tray (TRAY) to speed up construction
- + Modular system



showertec linear



showertec linear



"Full Tileable" Tileable cover



STL-CT

L1 = 54 mm

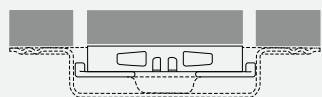

2

showertec linear >> COVER - Seamless tileable cover

L = mm	Art.	Finish	€ / pc	pc ■
600	STL- CT 600	Seamless tiled effect	73,53	1
700	STL- CT 700	Seamless tiled effect	79,10	1
800	STL- CT 800	Seamless tiled effect	85,44	1
900	STL- CT 900	Seamless tiled effect	93,14	1
1000	STL- CT 1000	Seamless tiled effect	100,03	1
1200	STL- CT 1200	Seamless tiled effect	107,25	1

Tileable seamless cover with tile support

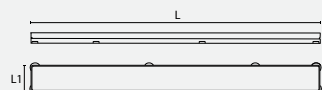

STL-CTF

L1 = 54 mm

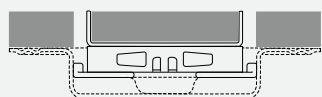

2

showertec linear >> COVER - Tileable cover with internal frame in Stainless Steel AISI 316 - DIN 1.4404

L = mm	Art.	Finish	€ / pc	pc ■
600	STL- CTF 600	Tileable with internal frame	101,05	1
700	STL- CTF 700	Tileable with internal frame	110,12	1
800	STL- CTF 800	Tileable with internal frame	120,34	1
900	STL- CTF 900	Tileable with internal frame	130,89	1
1000	STL- CTF 1000	Tileable with internal frame	141,21	1
1200	STL- CTF 1200	Tileable with internal frame	155,76	1

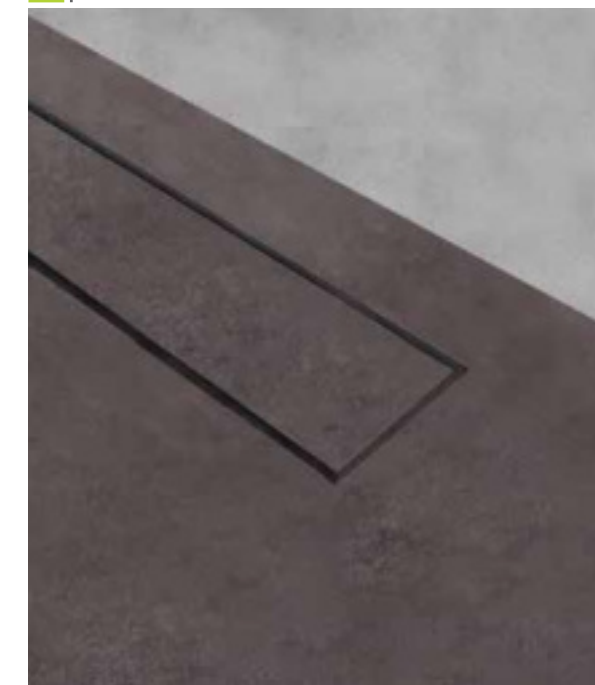

showertec linear STL-CT

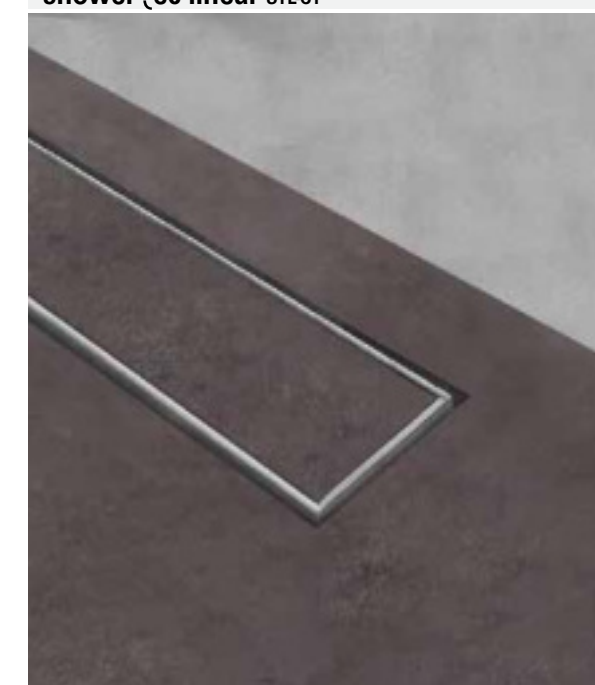

showertec linear STL-CTF



Cover in Aluminum Alu+

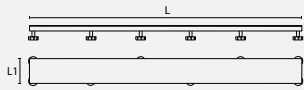

STL-C I
L1 = 54 mm

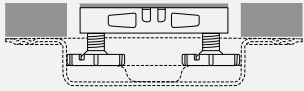

Floor thickness from 6 to 20 mm

Adjusting screw with protective cap included in the package



ILM ISM IXM IC
The images are inserted purely for illustrative purposes



showertec linear >> COVER - Cover in Stainless Steel AISI 316 - DIN 1.4404 - Polished

2

L = mm	STL-	C	Art.	Finish	€ / pc	pc ■
600	STL-	C	600ILM	Polished	148,42	1
700	STL-	C	700ILM	Polished	153,95	1
800	STL-	C	800ILM	Polished	161,22	1
900	STL-	C	900ILM	Polished	170,85	1
1000	STL-	C	1000ILM	Polished	180,60	1
1200	STL-	C	1200ILM	Polished	187,41	1



showertec linear >> COVER - Cover in Stainless Steel AISI 316 - DIN 1.4404 - Brushed

2

L = mm	STL-	C	Art.	Finish	€ / pc	pc ■
600	STL-	C	600ISM	Brushed	162,52	1
700	STL-	C	700ISM	Brushed	168,58	1
800	STL-	C	800ISM	Brushed	176,53	1
900	STL-	C	900ISM	Brushed	187,09	1
1000	STL-	C	1000ISM	Brushed	197,76	1
1200	STL-	C	1200ISM	Brushed	205,21	1



showertec linear >> COVER - Cover in Stainless Steel AISI 316 - DIN 1.4404 - Sanded

2

L = mm	STL-	C	Art.	Finish	€ / pc	pc ■
600	STL-	C	600IXM	Sanded	177,95	1
700	STL-	C	700IXM	Sanded	184,60	1
800	STL-	C	800IXM	Sanded	193,29	1
900	STL-	C	900IXM	Sanded	204,87	1
1000	STL-	C	1000IXM	Sanded	216,55	1
1200	STL-	C	1200IXM	Sanded	224,71	1



showertec linear >> COVER - Cover in Stainless Steel AISI 316 - DIN 1.4404 - Chrome

2

L = mm	STL-	C	Art.	Finish	€ / pc	pc ■
600	STL-	C	600IC	Chrome	240,24	1
700	STL-	C	700IC	Chrome	249,21	1
800	STL-	C	800IC	Chrome	260,94	1
900	STL-	C	900IC	Chrome	276,56	1
1000	STL-	C	1000IC	Chrome	292,35	1
1200	STL-	C	1200IC	Chrome	303,35	1

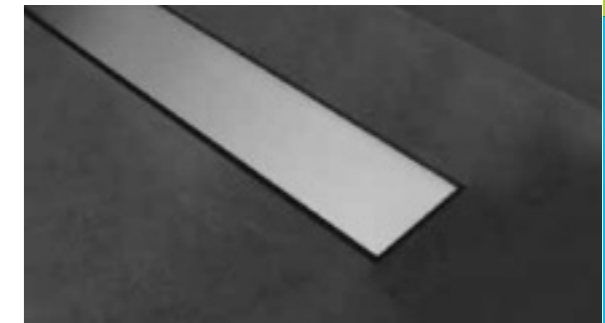

showertec linear STL-C ILM

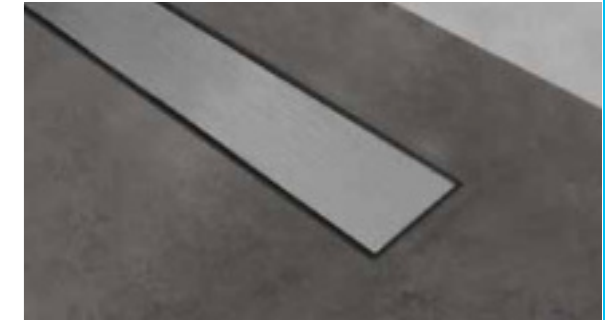

showertec linear STL-C IS

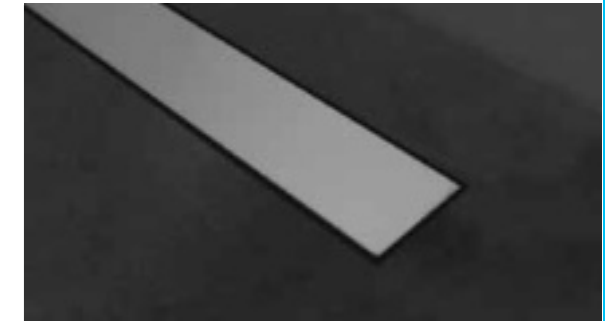

showertec linear STL-C IX

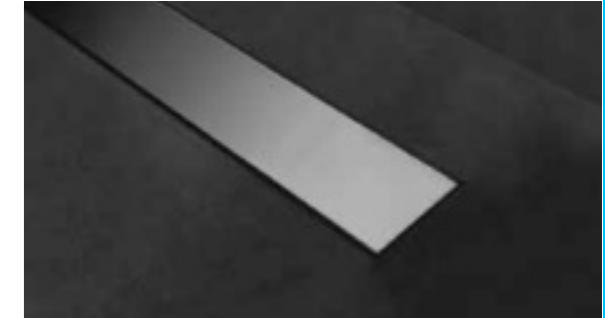

showertec linear STL-C IC

drainage channel

drainage



Cover in Aluminum Alu+

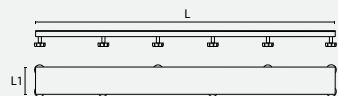

STL-C A

L1 = 54 mm

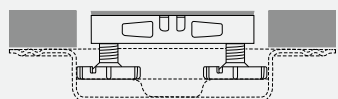

Floor thickness from 6 to 20 mm

Adjusting screw with protective cap included in the package

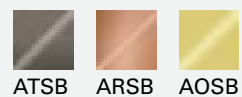

The images are inserted purely for illustrative purposes

showertec linear >> COVER - Cover in Anodized Aluminum ALU+

2

L = mm	Art.	Finish	Variant	€ / pc	pc ■
600	STL- C 600AT	Anodized	Titan	139,52	1
700	STL- C 700AT	Anodized	Titan	144,72	1
800	STL- C 800AT	Anodized	Titan	151,54	1
900	STL- C 900AT	Anodized	Titan	160,61	1
1000	STL- C 1000AT	Anodized	Titan	169,78	1
1200	STL- C 1200AT	Anodized	Titan	176,16	1
600	STL- C 600AR	Anodized	Copper	139,52	1
700	STL- C 700AR	Anodized	Copper	144,72	1
800	STL- C 800AR	Anodized	Copper	151,54	1
900	STL- C 900AR	Anodized	Copper	160,61	1
1000	STL- C 1000AR	Anodized	Copper	169,78	1
1200	STL- C 1200AR	Anodized	Copper	176,16	1
600	STL- C 600AO	Anodized	Gold	139,52	1
700	STL- C 700AO	Anodized	Gold	144,72	1
800	STL- C 800AO	Anodized	Gold	151,54	1
900	STL- C 900AO	Anodized	Gold	160,61	1
1000	STL- C 1000AO	Anodized	Gold	169,78	1
1200	STL- C 1200AO	Anodized	Gold	176,16	1

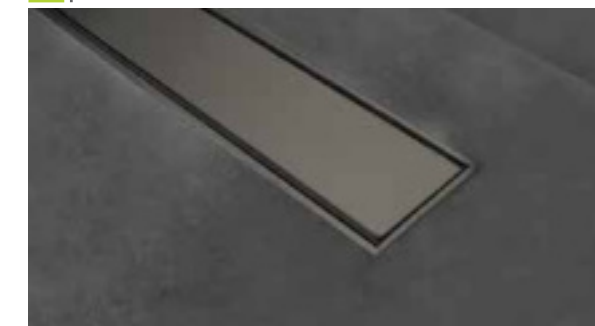

showertec linear STL-C AT

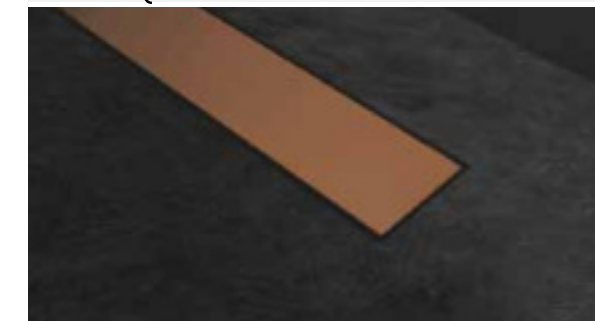

showertec linear STL-C AR

showertec linear >> COVER - Cover in Bright Polished Brushed Anodized Aluminum ALU+

2

L = mm	Art.	Finish	Variant	€ / pc	pc ■
600	STL- C 600ASSB	Bright Polished Brushed Anodized	Silver	139,52	1
700	STL- C 700ASSB	Bright Polished Brushed Anodized	Silver	144,72	1
800	STL- C 800ASSB	Bright Polished Brushed Anodized	Silver	151,54	1
900	STL- C 900ASSB	Bright Polished Brushed Anodized	Silver	160,61	1
1000	STL- C 1000ASSB	Bright Polished Brushed Anodized	Silver	169,78	1
1200	STL- C 1200ASSB	Bright Polished Brushed Anodized	Silver	176,16	1
600	STL- C 600ATSB	Bright Polished Brushed Anodized	Titan	139,52	1
700	STL- C 700ATSB	Bright Polished Brushed Anodized	Titan	144,72	1
800	STL- C 800ATSB	Bright Polished Brushed Anodized	Titan	151,54	1
900	STL- C 900ATSB	Bright Polished Brushed Anodized	Titan	160,61	1
1000	STL- C 1000ATSB	Bright Polished Brushed Anodized	Titan	169,78	1
1200	STL- C 1200ATSB	Bright Polished Brushed Anodized	Titan	176,16	1
600	STL- C 600ARSB	Bright Polished Brushed Anodized	Copper	139,52	1
700	STL- C 700ARSB	Bright Polished Brushed Anodized	Copper	144,72	1
800	STL- C 800ARSB	Bright Polished Brushed Anodized	Copper	151,54	1
900	STL- C 900ARSB	Bright Polished Brushed Anodized	Copper	160,61	1
1000	STL- C 1000ARSB	Bright Polished Brushed Anodized	Copper	169,78	1
1200	STL- C 1200ARSB	Bright Polished Brushed Anodized	Copper	176,16	1
600	STL- C 600AOSB	Bright Polished Brushed Anodized	Gold	139,52	1
700	STL- C 700AOSB	Bright Polished Brushed Anodized	Gold	144,72	1
800	STL- C 800AOSB	Bright Polished Brushed Anodized	Gold	151,54	1
900	STL- C 900AOSB	Bright Polished Brushed Anodized	Gold	160,61	1
1000	STL- C 1000AOSB	Bright Polished Brushed Anodized	Gold	169,78	1
1200	STL- C 1200AOSB	Bright Polished Brushed Anodized	Gold	176,16	1



showertec linear STL-C ASSB

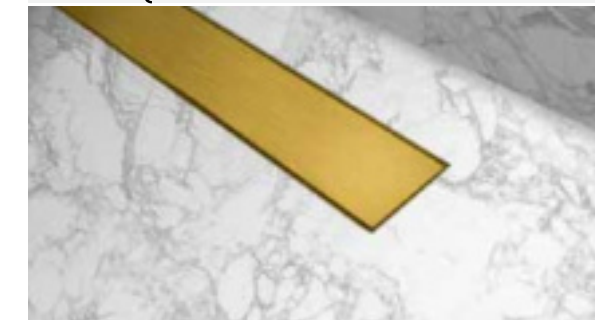

showertec linear STL-C AOSB

cover for shower channel stl

drainage

Cover in Aluminum Alu+

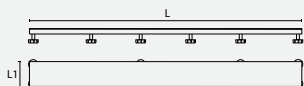

STL-C A
L1 = 54 mm

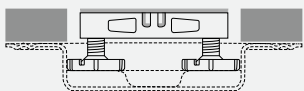

Floor thickness from 6 to 20 mm

Adjusting screw with protective cap included in the package

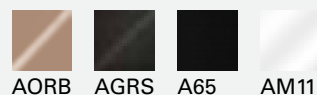

The images are inserted purely for illustrative purposes

2

showertec linear >> COVER - Cover in Aluminum ALU+ Bright Anodized

L = mm	STL-	C	Art.	Finish	Variant	€ / pc	pc ■
600	STL-	C	600AORB	Bright Polished Anodized	Pink Gold	198,43	1
700	STL-	C	700AORB	Bright Polished Anodized	Pink Gold	205,82	1
800	STL-	C	800AORB	Bright Polished Anodized	Pink Gold	215,52	1
900	STL-	C	900AORB	Bright Polished Anodized	Pink Gold	228,43	1
1000	STL-	C	1000AORB	Bright Polished Anodized	Pink Gold	241,46	1
1200	STL-	C	1200AORB	Bright Polished Anodized	Pink Gold	250,54	1

2

showertec linear >> COVER - Cover in Aluminum ALU+ Brushed Anodized

L = mm	STL-	C	Art.	Finish	Variant	€ / pc	pc ■
600	STL-	C	600AGRS	Brushed Anodized	Graphite	139,52	1
700	STL-	C	700AGRS	Brushed Anodized	Graphite	144,72	1
800	STL-	C	800AGRS	Brushed Anodized	Graphite	151,54	1
900	STL-	C	900AGRS	Brushed Anodized	Graphite	160,61	1
1000	STL-	C	1000AGRS	Brushed Anodized	Graphite	169,78	1
1200	STL-	C	1200AGRS	Brushed Anodized	Graphite	176,16	1
600	STL-	C	600AMSB	Brushed Anodized	Antique Bronze	139,52	1
700	STL-	C	700AMSB	Brushed Anodized	Antique Bronze	144,72	1
800	STL-	C	800AMSB	Brushed Anodized	Antique Bronze	151,54	1
900	STL-	C	900AMSB	Brushed Anodized	Antique Bronze	160,61	1
1000	STL-	C	1000AMSB	Brushed Anodized	Antique Bronze	169,78	1
1200	STL-	C	1200AMSB	Brushed Anodized	Antique Bronze	176,16	1

2

showertec linear >> COVER - Cover in Aluminum ALU+ Painted

L = mm	STL-	C	Art.	Finish	Variant	€ / pc	pc ■
600	STL-	C	600AM11	Pow. Coated	Matt White	139,52	1
700	STL-	C	700AM11	Pow. Coated	Matt White	144,72	1
800	STL-	C	800AM11	Pow. Coated	Matt White	151,54	1
900	STL-	C	900AM11	Pow. Coated	Matt White	160,61	1
1000	STL-	C	1000AM11	Pow. Coated	Matt White	169,78	1
1200	STL-	C	1200AM11	Pow. Coated	Matt White	176,16	1
600	STL-	C	600A65	Pow. Coated	Embossed matt Black	139,52	1
700	STL-	C	700A65	Pow. Coated	Embossed matt Black	144,72	1
800	STL-	C	800A65	Pow. Coated	Embossed matt Black	151,54	1
900	STL-	C	900A65	Pow. Coated	Embossed matt Black	160,61	1
1000	STL-	C	1000A65	Pow. Coated	Embossed matt Black	169,78	1
1200	STL-	C	1200A65	Pow. Coated	Embossed matt Black	176,16	1

+ Aluminum Alu+



- + Special naval anodizing
- + Extremely resistant to chemicals and salt water
- + Average thickness of anodized layer greater than 20 µm

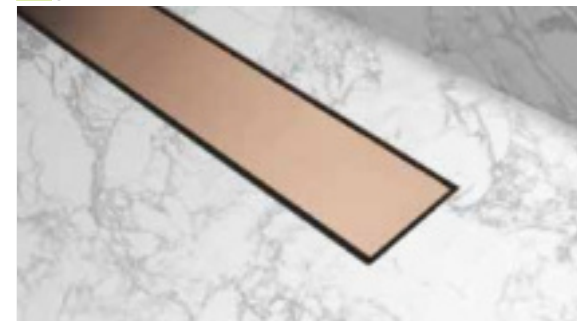

showertec linear STL-C AORB



showertec linear STL-C AGRS



showertec linear STL-C AM11

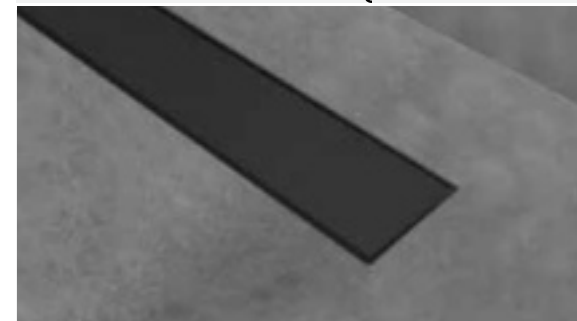

showertec linear STL-C A65



Flush wall frame

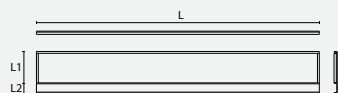

STL-FW

L1 = 72 mm

L2 = 20 mm

The cover has to be ordered separately, see pag. from 162 to 165.



ILM

The images are inserted purely for illustrative purposes

3

showertec linear >> WALL FRAME - Flush wall fram in Stainless Steel AISI 316 - DIN 1.4404 - Polished

L = mm	Art.	Finish	€ / pc	pc ■
600	STL- FW 600ILM	Polished	87,33	1
700	STL- FW 700ILM	Polished	90,71	1
800	STL- FW 800ILM	Polished	94,45	1
900	STL- FW 900ILM	Polished	98,74	1
1000	STL- FW 1000ILM	Polished	102,01	1
1200	STL- FW 1200ILM	Polished	110,05	1

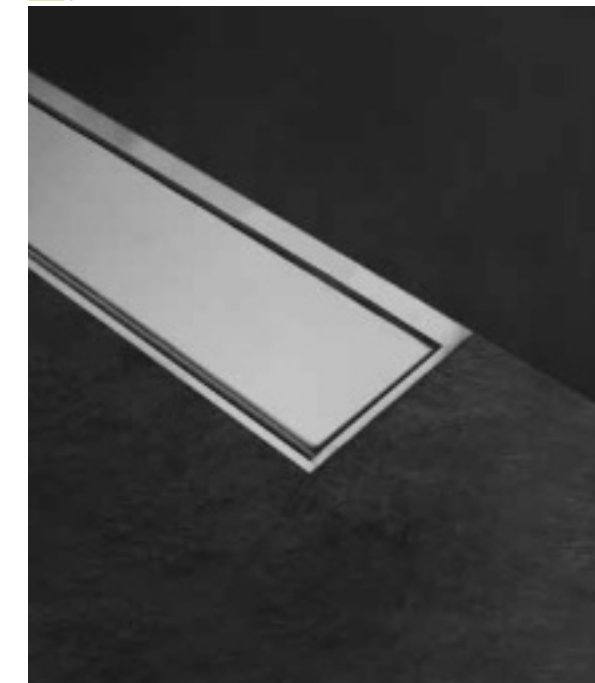

showertec linear STL-FW

Frame in Stainless Steel

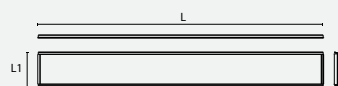

STL-F

L1 = 72 mm

The cover has to be ordered separately, see pag. from 162 to 165.



IL

The images are inserted purely for illustrative purposes

3

showertec linear >> FRAME - Frame in Stainless Steel AISI 316 - DIN 1.4404 - Polished

L = mm	Art.	Finish	€ / pc	pc ■
600	STL- F 600	Polished	79,39	1
700	STL- F 700	Polished	82,47	1
800	STL- F 800	Polished	85,87	1
900	STL- F 900	Polished	89,76	1
1000	STL- F 1000	Polished	92,74	1
1200	STL- F 1200	Polished	100,04	1

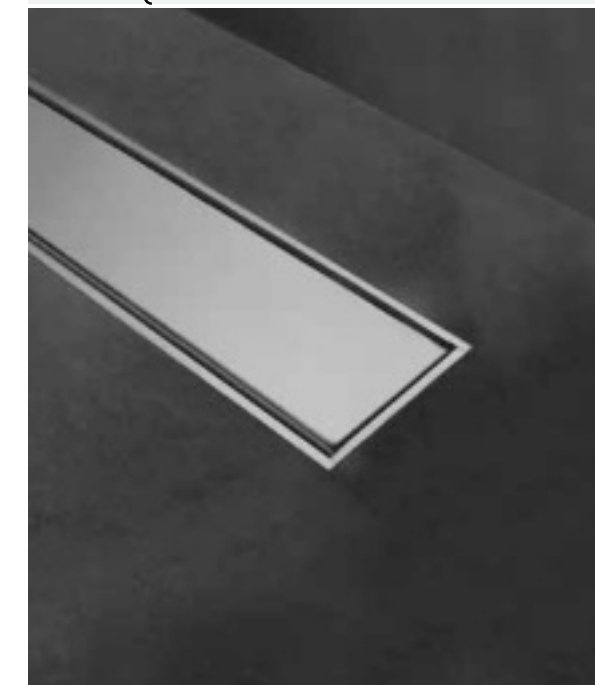

showertec linear STL-C IL + STL-F

Frame in Aluminum Alu+

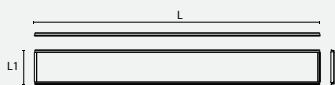

STL-F

The cover has to be ordered separately, see pag. from 162 to 165.



AT AR AO ASSB

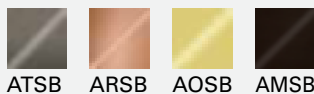

ATSB ARSB AOSB AMSB



AGRS AORB AM11 A65

The images are inserted purely for illustrative purposes

showertec linear >> FRAME - Frame in Aluminum Alu+ Anodized

L = mm	Art.	Finish	Variant	€ / pc	pc ■
600	STL- F600 A*	Anodized	AT / AR / AO	70,66	1
700	STL- F700 A*	Anodized	AT / AR / AO	73,41	1
800	STL- F800 A*	Anodized	AT / AR / AO	76,42	1
900	STL- F900 A*	Anodized	AT / AR / AO	79,89	1
1000	STL- F1000 A*	Anodized	AT / AR / AO	82,54	1
1200	STL- F1200 A*	Anodized	AT / AR / AO	89,03	1

3

showertec linear >> FRAME - Frame in Aluminum Alu+ Bright Brushed Anodized

L = mm	Art.	Finish	Variant	€ / pc	pc ■
600	STL- F600 A*SB	Bright Polished Brushed An.	ASSB / ATSB / ARSB / AOSB	70,66	1
700	STL- F700 A*SB	Bright Polished Brushed An.	ASSB / ATSB / ARSB / AOSB	73,41	1
800	STL- F800 A*SB	Bright Polished Brushed An.	ASSB / ATSB / ARSB / AOSB	76,42	1
900	STL- F900 A*SB	Bright Polished Brushed An.	ASSB / ATSB / ARSB / AOSB	79,89	1
1000	STL- F1000 A*SB	Bright Polished Brushed An.	ASSB / ATSB / ARSB / AOSB	82,54	1
1200	STL- F1200 A*SB	Bright Polished Brushed An.	ASSB / ATSB / ARSB / AOSB	89,03	1

3

showertec linear >> FRAME - Frame in Aluminum Alu+ Brushed Anodized

L = mm	Art.	Finish	Variant	€ / pc	pc ■
600	STL- F600 A*	Brushed Anodized	AMSB / AGRS	70,66	1
700	STL- F700 A*	Brushed Anodized	AMSB / AGRS	73,41	1
800	STL- F800 A*	Brushed Anodized	AMSB / AGRS	76,42	1
900	STL- F900 A*	Brushed Anodized	AMSB / AGRS	79,89	1
1000	STL- F1000 A*	Brushed Anodized	AMSB / AGRS	82,54	1
1200	STL- F1200 A*	Brushed Anodized	AMSB / AGRS	89,03	1

3

showertec linear >> FRAME - Frame in Aluminum Alu+ Pink Gold Bright Brushed Anodized

H = mm	Art.	Finish	Variant	€ / set	set ■
600	STL- F600 AORB	Bright Polished Anodized	AORB	94,88	1
700	STL- F700 AORB	Bright Polished Anodized	AORB	98,56	1
800	STL- F800 AORB	Bright Polished Anodized	AORB	102,61	1
900	STL- F900 AORB	Bright Polished Anodized	AORB	107,27	1
1000	STL- F1000 AORB	Bright Polished Anodized	AORB	110,82	1
1200	STL- F1200 AORB	Bright Polished Anodized	AORB	119,55	1

3

showertec linear >> FRAME - Frame in Aluminum Alu+ Painted

L = mm	Art.	Finish	Variant	€ / pc	pc ■
600	STL- F600 A*	Pow. Coated	AM11 / A65	70,66	1
700	STL- F700 A*	Pow. Coated	AM11 / A65	73,41	1
800	STL- F800 A*	Pow. Coated	AM11 / A65	76,42	1
900	STL- F900 A*	Pow. Coated	AM11 / A65	79,89	1
1000	STL- F1000 A*	Pow. Coated	AM11 / A65	82,54	1
1200	STL- F1200 A*	Pow. Coated	AM11 / A65	89,03	1

3

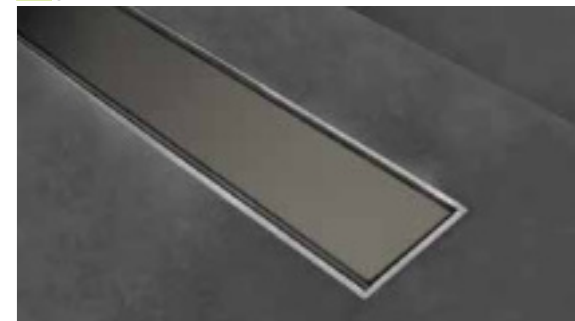

showertec linear STL-C AT + STL-F ASSB

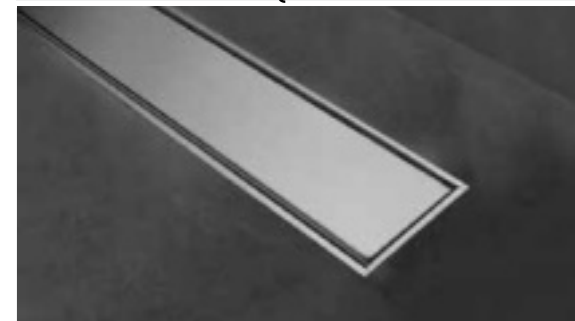

showertec linear STL-C IL + STL-F AORB

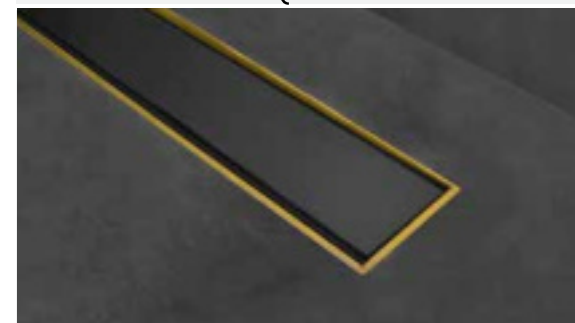

showertec linear STL-C AGRS + STL-F AO



showertec linear STL-C ARSB + STL-F ARSB



2% sloped tray for substrate installation

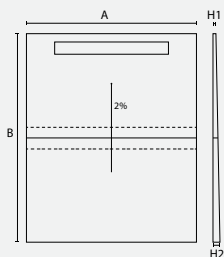

STL-TRAY
H1 = 15 mm
H2 = 37 mm

showertec linear >> TRAY - Waterproof pre-sloped Tray - 91,4 x 112 cm

AxB = cm	Art.	Finish	€ / pc	pc ■
91x112	STL- TRAY 91/112	covered with fiber-reinforced concrete	150,31	1

4

For channels with lengths equal to 600, 700, 800 mm

showertec linear >> TRAY - Waterproof pre-sloped Tray - 132 x 112 cm

AxB = cm	Art.	Finish	€ / pc	pc ■
132x112	STL- TRAY 132/112	covered with fiber-reinforced concrete	196,97	1

4

Suitable for all shower channel lengths



showertec linear TRAY

Extension for 2% sloped tray for substrate installation

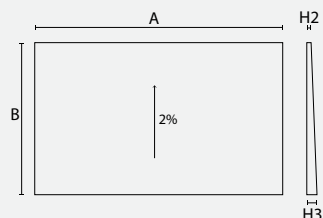

STL-EXTENSION
H2 = 37 mm
H3 = 48 mm

showertec linear >> EXTENSION - Extension for waterproof pre-sloped tray - 91,4 x 56 cm

AxB = cm	Art.	Finish	€ / pc	pc ■
91x56	STL- EXT 91/56	covered with fiber-reinforced concrete	96,50	1

4a

Allows the extension of the pre-sloped shower tray Showertec Linear TRAY to 168 cm

showertec linear >> EXTENSION - Waterproof Extension for pre-sloped tray - 132 x 56 cm

AxB = cm	Art.	Finish	€ / pc	pc ■
132x56	STL- EXT 132/56	covered with fiber-reinforced concrete	127,16	1

4a

Allows the extension of the pre-sloped shower tray Showertec Linear TRAY to 168 cm



showertec linear TRAY + EXTENSION

2% sloped tray with riser panel

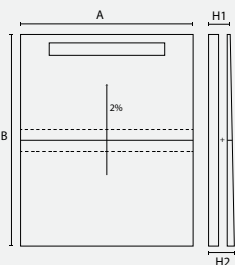

STL-TRAY-R
H1 = 68 mm
H2 = 90 mm

showertec linear >> TRAY - Waterproof pre-sloped Tray - 91,4 x 112 cm - with riser panel

AxB = cm	Art.	Finish	€ / pc	pc ■
91x112	STL- TRAY 91/112R	covered with fiber-reinforced concrete	199,32	1

4a

For channels with lengths equal to 600, 700, 800 mm

showertec linear >> TRAY - Waterproof pre-sloped Tray - 132 x 112 cm - with riser panel

AxB = cm	Art.	Finish	€ / pc	pc ■
132x112	STL- TRAY 132/112R	covered with fiber-reinforced concrete	250,39	1

4a

For channels with lengths equal to 900, 1000, 1200 mm

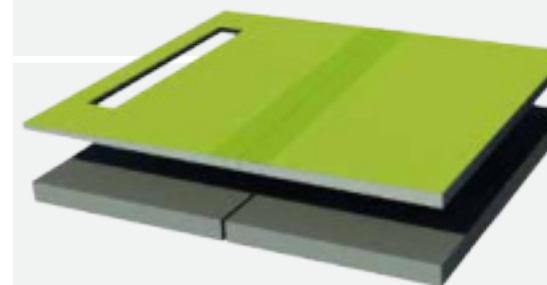

showertec linear Tray with RISER



2% sloped tray for substrate installation

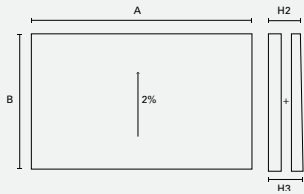

STL-EXTENSION-R

H2 = 90 mm
H3 = 101 mm

4a

showertec linear >> EXTENSION - Waterproof pre-sloped Tray - 91,4 x 56 cm - with riser panel

AxB = cm	Art.	Finish	€ / pc	pc ■
91x56	STL- EXT 91/56R	covered with fiber-reinforced concrete	199,32	1

Allows the extension of the pre-sloped shower tray with riser panel Showertec LinearTRAY to 168 cm

4a

showertec linear >> EXTENSION - Waterproof pre-sloped Tray - 132 x 56 cm - with riser panel

AxB = cm	Art.	Finish	€ / pc	pc ■
132x56	STL- EXT 132/56R	covered with fiber-reinforced concrete	250,39	1

Allows the extension of the pre-sloped shower tray with riser panel Showertec LinearTRAY to 168 cm

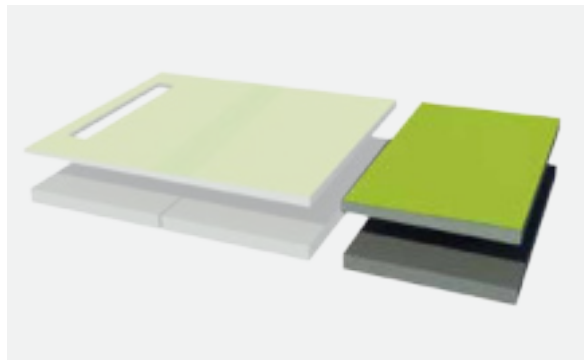

showertec linear TRAY with RISER + EXTENSION with RISER

Pre-sloped Ramp

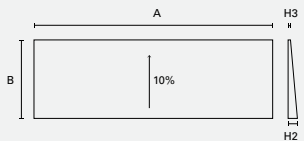

STL-RAMP

H2 = 37 mm
H3 = 6 mm

4

showertec linear >> RAMP - Waterproof ramp - 132 x 30 cm

AxB = cm	Art.	Finish	€ / pc	pc ■
132x30	STL- RAMP 132/32	covered with fiber-reinforced concrete	80,73	1

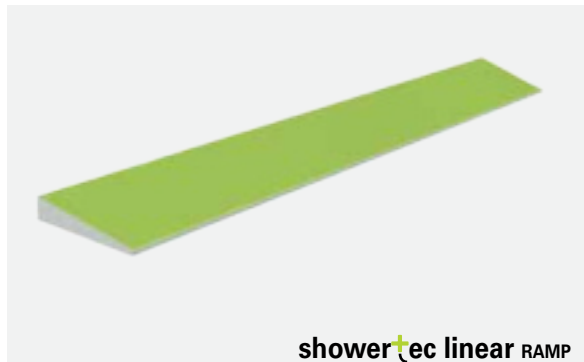

showertec linear RAMP

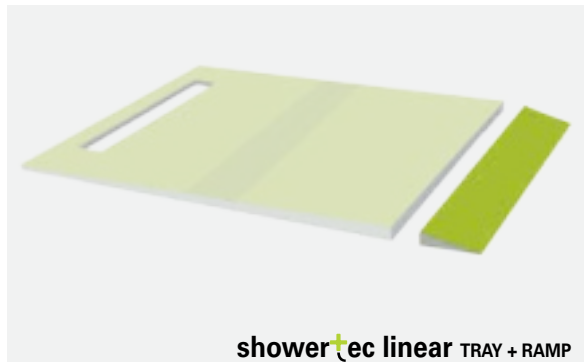

showertec linear TRAY + RAMP





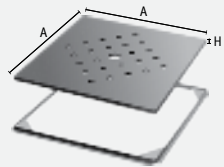

PD-IS

Copridrain >> PD Drain well in St. Steel AISI 304 with frame for thin-set adhesive installation

A/H = mm	Art.	Finish	€ / pc	pc ■
100 / 8	PD 100/8 IS	Brushed	52,18	1
100 / 10	PD 100/10 IS	Brushed	53,20	1
150 / 8	PD 150/8 IS	Brushed	58,09	1
150 / 10	PD 150/10 IS	Brushed	59,05	1
200 / 8	PD 200/8 IS	Brushed	64,32	1
200 / 10	PD 200/10 IS	Brushed	65,33	1

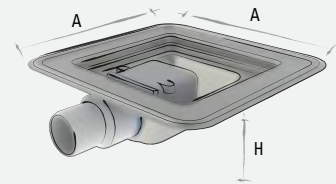

Removable siphon
Stainless Steel
Outlet of 40 mm diameter

Square Drain >> SDS 150 IL/*Evacuation Unit in Stainless Steel AISI 316 - DIN 1.4404

A/H = mm	Art.	Finish	€ / pc	pc ■
228 / 54	SDS 150 IL/N	Polished	140,13	1
228 / 54	SDS 150 IL/S	Sanded	147,26	1
170 / 54	SDS 150 IL/M	With membrane	193,57	1

SDS 150 ILM 170x170 is perimeter size. The sites with membrane are 330x330.

grid STAR >> SDG 150 IL/S Grating with slits in Stainless Steel AISI 316 - DIN 1.4404 - Polished

A/H = mm	Art.	Finish	€ / pc	pc ■
150 / 6-20	SDG 150 IL/S	Polished	91,45	1

grid PLANO >> SDG 150 IL/PT Plane grating in Stainless Steel AISI 316 - DIN 1.4404 - Brushed

A/H = mm	Art.	Finish	€ / pc	pc ■
150 / 6-20	SDG 150 IL/PT	Brushed	77,20	1

grid TILE >> SDG 150 IL/T To Be Tiled grating in Stainless Steel AISI 316 - DIN 1.4404

A/H = mm	Art.	Finish	€ / pc	pc ■
150 / 6-20	SDG 150 IL/T	To Be Tiled	34,44	1



Copridrain PD



Square Drain STAR

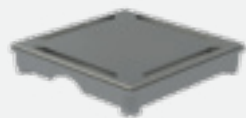

SDG 150 IL / S

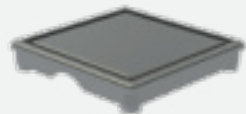

SDG 150 IL / PT



SDG 150 IL / T





Length: 1,20 meters or 2,00 meters

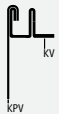
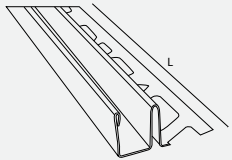

KPV + KV

profile for glass >> KV in Stainless Steel for glass thickness from 8 mm or 10 mm

L = mm	Art.	Finish	Variant	€ / m	pc ■
1200	KV 19/08 IS120	Brushed	suitable for glass thickness 8mm	38,03	1
1200	KV 19/10 IS120	Brushed	suitable for glass thickness 10mm	37,23	1
2000	KV 19/08 IS200	Brushed	suitable for glass thickness 8mm	36,33	1
2000	KV 19/10 IS200	Brushed	suitable for glass thickness 10mm	35,06	1

conical profile >> KPV in Stainless Steel AISI 304 - DIN 1.4301 - For floor-level showers installations

H/H1 mm	Art.	Finish	€ / m	pc ■
19 / 46	KPV 46 IS135DX	Brushed	24,78	1
19 / 46	KPV 46 IS135SX	Brushed	24,78	1
19 / 59	KPV 59 IS200DX	Brushed	25,36	1
19 / 59	KPV 59 IS200SX	Brushed	25,36	1

Conical profile in Brushed Stainless Steel AISI 304 with height from 19 mm to 46/59 mm and 2% sloped. Standard length. 1,35 meters / 2,00 meters which can be cut on site. This profile must be combined with KV.

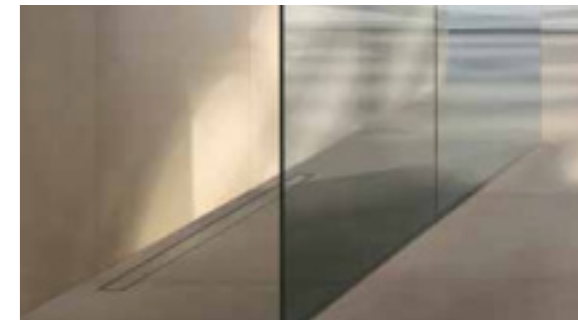

Shower profile KV

Length: 1,35 meters / 2,00 meters which can be cut on site.



KP 35 IS

KP + TR

conical profile >> KP in Stainless Steel AISI 304 - DIN 1.4301 - For floor-level showers installations

H/H1 mm	Art.	Finish	€ / m	pc ■
8 / 35	KP 35 IS135DX	Brushed	24,33	1
8 / 35	KP 35 IS135SX	Brushed	24,33	1
8 / 48	KP 48 IS200DX	Brushed	25,47	1
8 / 48	KP 48 IS200SX	Brushed	25,47	1

A conical brushed steel profile in AISI 304 with A at 8mm and B at 35mm giving a 2% gradient. Standard length 1,35m which can be cut on site. This profile needs to be used inserting in our TR 6, 8, 10, 12,5mm.

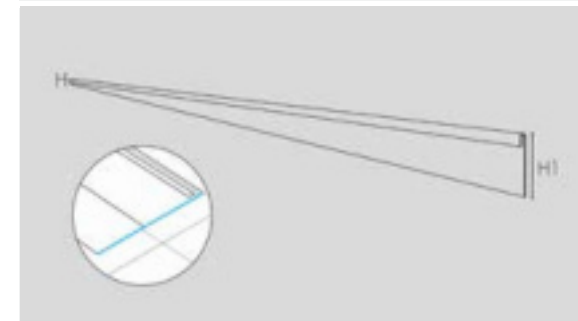

Conical profile floor - floor KP

Length: 1,35 m

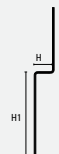

KR - IS 135

conical profile >> KR in Stainless Steel AISI 304 - DIN 1.4301 - For floor-level showers installations

H/H1 mm	Art.	Finish	€ / m	pc ■
8 / 35	KR 80 IS135DX	Brushed	33,39	1
8 / 35	KR 80 IS135SX	Brushed	33,39	1
10 / 35	KR 100 IS135DX	Brushed	33,86	1
10 / 35	KR 100 IS135SX	Brushed	33,86	1
12,5 / 35	KR 125 IS135DX	Brushed	34,31	1
12,5 / 35	KR 125 IS135SX	Brushed	34,31	1

Conical profile in Brushed Stainless Steel AISI 304 from 8 mm to 35 mm height and 2% slope.

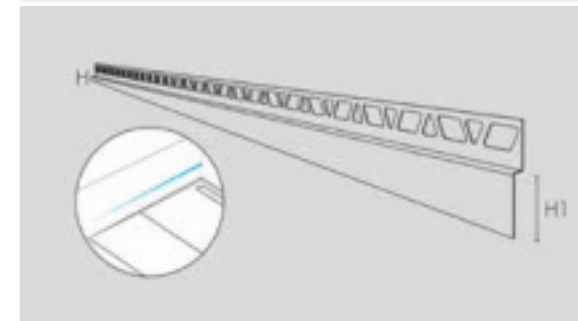

Conical profile floor - wall KR

Length: 1,35 m

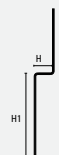

KF - IS 135

frontal profile >> KF in Stainless Steel AISI 304 - DIN 1.4301 - For floor-level showers installations

H/H1 mm	Art.	Finish	€ / m	pc ■
8 / 28	KF 8/28 IS135	Brushed	28,77	1
10 / 28	KF 10/28 IS135	Brushed	28,77	1
12 / 28	KF 12/28 IS135	Brushed	28,77	1
8 / 34	KF 8/34 IS135	Brushed	29,71	1
10 / 34	KF 10/34 IS135	Brushed	29,71	1
12 / 34	KF 12/34 IS135	Brushed	29,71	1

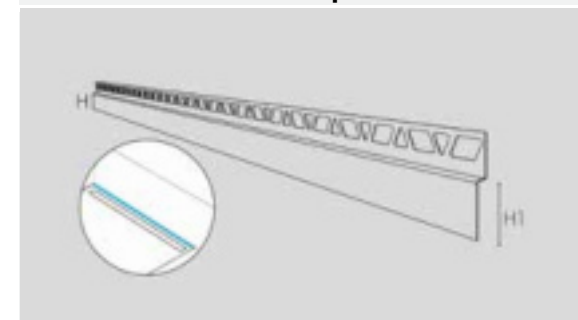

Conical profile floor - wall KF



Maximum system length with one drain outlet: 9,20 m

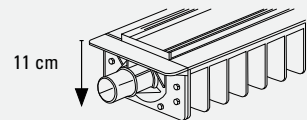

MUD

multidrain >> MUD Linear Tileable Drainage System "Design + Function"

L = mm	Art.	Finish	€/ pc	pc ■
1500	MUD 1500 H	Channel module with steep slope	275,48	1
1500	MUD 1500 M	Channel module with medium slope	275,48	1
1500	MUD 1500 L	Channel module with gradual slope	275,48	1

multidrain >> Accessories for MUD

L = mm	Art.	Finish	€/ pc	pc ■
	MUD 100 T	Endplate	55,49	1
50	MUD 50 S	Endplate with drain outlet ø50 mm	57,77	1
75	MUD 75 HS	Shower drain ø75 mm	56,64	1
75	MUD 75 LS	Shower drain ø75 mm	56,64	1
200	MUD 90 S	Run-off pine	46,57	1
50	MUD 50 C	Endcap ø50 mm	2,40	1
75	MUD 75 C	Endcap ø75 mm	3,04	1
1500	MUD 1500 GPIL	Tile grating Stainless Steel 304-Polished	128,55	1
200	MUD 200 GPIL	Tile grating Stainless Steel 304-Polished	35,73	1
1500	MUD 1500 GAIS	Grating Satin Stainless Steel AISI 304	124,23	1
200	MUD 200 GAIS	Grating Satin Stainless Steel AISI 304	36,73	1
	MUD / KIT	Mounting kit	38,27	1

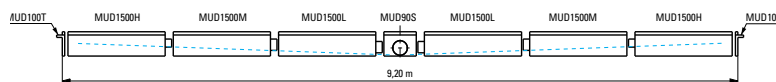

Example of the maximum development of the Multidrain system with one drain (for other applications see the catalogue)

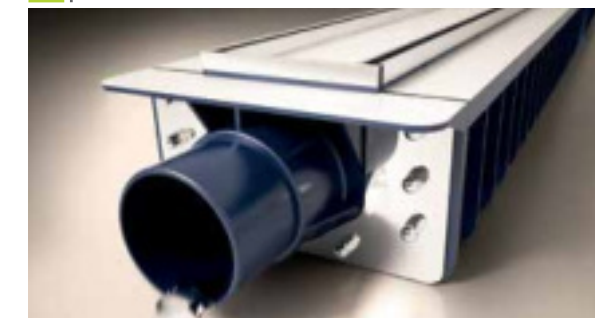

Multidrain MUD 1500



Multidrain

Maximum system length with one drain outlet: 6,25 m

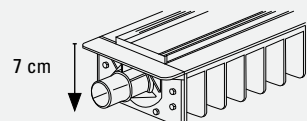

MUDR

multidrain >> MUDR Linear Tileable Drainage System "Design + Function"

L = mm	Art.	Finish	€/ pc	pc ■
1500	MUDR 1500 H	Channel module with steep slope	309,58	1
1500	MUDR 1500 L	Channel module with gradual slope	309,58	1

multidrain >> Accessories for MUDR

L = mm	Art.	Finish	€/ pc	pc ■
	MUDR 100 T	Endplate	62,38	1
50	MUDR 50 DS	Double run-off pine	52,87	1
50	MUDR 50 HS	Endplate with drain outlet ø50 mm	64,93	1
50	MUDR 50 LS	Endplate with drain outlet ø50 mm	64,93	1
50	MUD 50 C	Endcap ø50 mm	2,40	1
1500	MUD 1500 GPIL	Tile grating Stainless Steel 304-Polished	128,55	1
1500	MUD 1500 GAIS	Grating Satin Stainless Steel AISI 304	124,23	1
250	MUDR 250 GPIL	Tile grating Stainless Steel 304-Polished	44,09	1
250	MUDR 250 GAIS	Grating Satin Stainless Steel AISI 304	46,87	1
	MUDR / KIT	Mounting kit	42,58	1

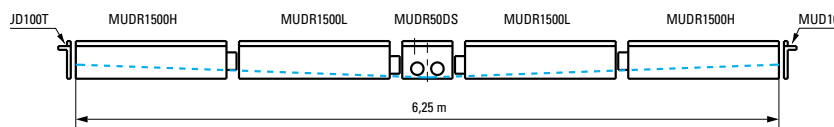

Multidrain application example: (for other applications see the catalogue)



Multidrain MUDR



Multidrain



DIY profiles

To complete the vast selection of profiles, Profilitec also proposes a series of do-it-yourself profiles. L, U, T, tube- shaped profiles and many other designs are available in numerous materials and finishes for all your design needs.

Article
various section

Code

Use
various section

Pag.
178





Length: 2,00 meters

Indivisible packaging



PA-IL
Length: 2,00 meters

Short length: 1m on request.

Indivisible packaging

White cod. €/m 1,05

Black cod. €/m 1,05

On request available with bar codes
+€/m 0,56for minimum order of 100
pieces also mixed.

Indivisible packaging

AS= Anodized Amuninum Silver

AO= Anodized Amuninum Gold

AB= Anodized Amuninum Bronze



PA-A



PP-A

profiles >> PA Equal angled section in Stainless Steel- thickness = 1 mm

H = mm	Art.	Finish	€/ m	pc ■
15 x 15	PA 15X15 IL	Polished	5,44	10
20 x 20	PA 20X20 IL	Polished	6,92	10
25 x 25	PA 25X25 IL	Polished	8,49	10
30 x 30	PA 30X30 IL	Polished	10,29	10
35 x 35	PA 35X35 IL	Polished	11,68	10
40 x 40	PA 40X40 IL	Polished	13,42	10
50x 50	PA 50X50 IL	Polished	16,10	10

profiles >> PL "L" profile in Stainless Steel- thickness = 1 mm

H = mm	Art.	Finish	€/ m	pc ■
15 x 10	PL 15X10 IL	Polished	4,57	10
20 x 10	PL 20X10 IL	Polished	5,44	10
30 x 15	PL 30X15 IL	Polished	7,31	10

profiles >> PA Equal angled section in Anodized Aluminum- thickness = 1 mm

H = mm	Art.	Finish	Variant	€/ m	pc ■
10 x 10	PA 10X10 AS	Anodized	Silver	2,20	10
15 x 15	PA 15X15 AS	Anodized	Silver	2,46	10
20 x 20	PA 20X20 AS	Anodized	Silver	3,04	10
25 x 25	PA 25X25 AS	Anodized	Silver	3,39	10
30 x 30	PA 30X30 AS	Anodized	Silver	5,36	10
40 x 40	PA 40X40 AS	Anodized	Silver	6,93	10
10 x 10	PA 10X10 AO	Anodized	Gold	2,20	10
15 x 15	PA 15X15 AO	Anodized	Gold	2,46	10
20 x 20	PA 20X20 AO	Anodized	Gold	3,04	10
25 x 25	PA 25X25 AO	Anodized	Gold	3,39	10
30 x 30	PA 30X30 AO	Anodized	Gold	5,36	10
40 x 40	PA 40X40 AO	Anodized	Gold	6,93	10
10 x 10	PA 10X10 AB	Anodized	Bronze	2,20	10
15 x 15	PA 15X15 AB	Anodized	Bronze	2,46	10
20 x 20	PA 20X20 AB	Anodized	Bronze	3,04	10
25 x 25	PA 25X25 AB	Anodized	Bronze	3,39	10
30 x 30	PA 30X30 AB	Anodized	Bronze	5,36	10
40 x 40	PA 40X40 AB	Anodized	Bronze	6,93	10

profiles >> PP Flat Profile in Anodized Aluminum- thickness = 2 mm

H = mm	Art.	Finish	Variant	€/ m	pc ■
12	PP 12X2 AS	Anodized	Silver	2,20	10
15	PP 15X2 AS	Anodized	Silver	2,64	10
20	PP 20X2 AS	Anodized	Silver	2,98	10
25	PP 25X2 AS	Anodized	Silver	3,39	10
30	PP 30X2 AS	Anodized	Silver	3,91	10
12	PP 12X2 AO	Anodized	Gold	2,20	10
15	PP 15X2 AO	Anodized	Gold	2,64	10
20	PP 20X2 AO	Anodized	Gold	2,98	10
25	PP 25X2 AO	Anodized	Gold	3,39	10
30	PP 30X2 AO	Anodized	Gold	3,91	10
12	PP 12X2 AB	Anodized	Bronze	2,20	10
15	PP 15X2 AB	Anodized	Bronze	2,64	10
20	PP 20X2 AB	Anodized	Bronze	2,98	10
25	PP 25X2 AB	Anodized	Bronze	3,39	10
30	PP 30X2 AB	Anodized	Bronze	3,91	10

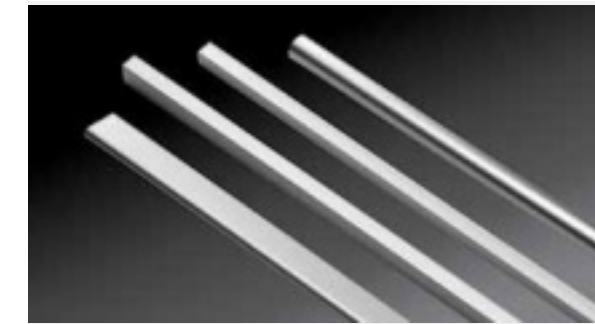

Silver



Gold



Bronze

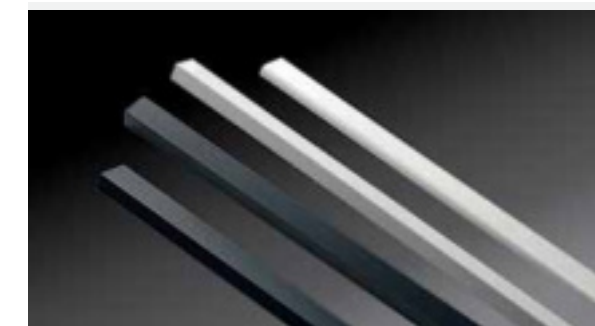

White and black



Length: 2,00 meters

Short length: 1m on request.

Indivisible packaging

White cod. €/m 1,05

Black cod. €/m 1,05

On request available with bar codes

+€/m 0,56 for minimum order of 100

pieces also mixed.

Indivisible packaging

AS= Anodized Amuninum Silver

AO= Anodized Amuninum Gold

AB= Anodized Amuninum Bronze



PL-A



PU-A



UN-A



TT-A

profiles >> PL "L" profile in Anodized Aluminum- thickness = 1 mm

H = mm	Art.	Finish	Variant	€/ m	pc ■
15 x 10	PL 15X10 AS	Anodized	Silver	2,20	10
20 x 10	PL 20X10 AS	Anodized	Silver	2,41	10
30 x 15	PL 30X15 AS	Anodized	Silver	3,10	10
15 x 10	PL 15X10 AO	Anodized	Gold	2,20	10
20 x 10	PL 20X10 AO	Anodized	Gold	2,41	10
30 x 15	PL 30X15 AO	Anodized	Gold	3,10	10
15 x 10	PL 15X10 AB	Anodized	Bronze	2,20	10
20 x 10	PL 20X10 AB	Anodized	Bronze	2,41	10
30 x 15	PL 30X15 AB	Anodized	Bronze	3,10	10

profiles >> PU "U" profile in Anodized Aluminum- thickness = 1 mm

H = mm	Art.	Finish	Variant	€/ m	pc ■
8 x 8	PU 8X8 AS	Anodized	Silver	2,20	10
10 x 10	PU 10X10 AS	Anodized	Silver	2,44	10
10 x 15	PU 10X15 AS	Anodized	Silver	3,04	10
8 x 8	PU 8X8 AO	Anodized	Gold	2,20	10
10 x 10	PU 10X10 AO	Anodized	Gold	2,44	10
10 x 15	PU 10X15 AO	Anodized	Gold	3,04	10
8 x 8	PU 8X8 AB	Anodized	Bronze	2,20	10
10 x 10	PU 10X10 AB	Anodized	Bronze	2,44	10
10 x 15	PU 10X15 AB	Anodized	Bronze	3,04	10

profiles >> UN Bullnosed profile in Anodized Aluminum

H = mm	Art.	Finish	Variant	€/ m	pc ■
18	UN 18 AS	Anodized	Silver	2,46	10
22	UN 22 AS	Anodized	Silver	2,64	10
25	UN 25 AS	Anodized	Silver	2,66	10
18	UN 18 AO	Anodized	Gold	2,46	10
22	UN 22 AO	Anodized	Gold	2,64	10
25	UN 25 AO	Anodized	Gold	2,66	10
18	UN 18 AB	Anodized	Bronze	2,46	10
22	UN 22 AB	Anodized	Bronze	2,64	10
25	UN 25 AB	Anodized	Bronze	2,66	10

profiles >> TT Round in Anodized Aluminum- thickness = 1 mm

H = mm	Art.	Finish	Variant	€/ m	pc ■
15	TT 15 AS	Anodized	Silver	3,10	10
18	TT 18 AS	Anodized	Silver	3,53	10
20	TT 20 AS	Anodized	Silver	3,91	10
15	TT 15 AO	Anodized	Gold	3,10	10
18	TT 18 AO	Anodized	Gold	3,53	10
20	TT 20 AO	Anodized	Gold	3,91	10
15	TT 15 AB	Anodized	Bronze	3,10	10
18	TT 18 AB	Anodized	Bronze	3,53	10

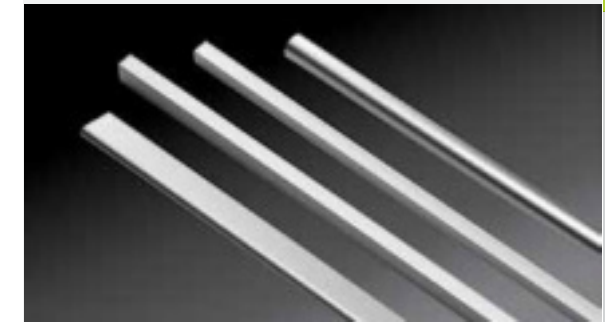

Silver



Gold



Bronze

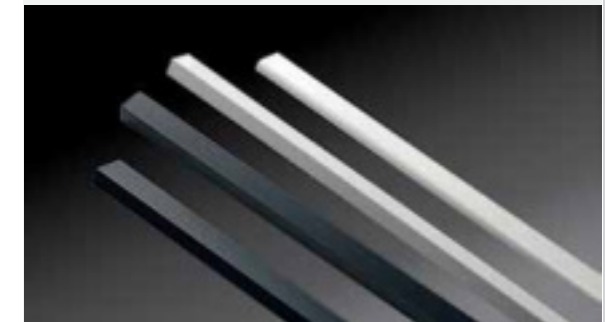

White and black

various section

DIY profiles



Length: 2,00 meters

Short length: 1m on request.

Indivisible packaging

White cod. €/m 1,05

Black cod. €/m 1,05

On request available with bar codes

+€/m 0,56 for minimum order of 100

pieces also mixed.

Indivisible packaging

AS= Anodized Amuninum Silver

AO= Anodized Amuninum Gold

AB= Anodized Amuninum Bronze



TQ-A



RE-A



CD-A

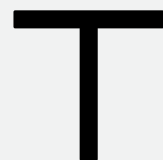

PT-A



TO-A



QU-A

profiles >> TQ Square in Anodized Aluminum- thickness = 1 mm

H = mm	Art.	Finish	Variant	€/ m	pc ■
10 x 10	TQ 10X10 AS	Anodized	Silver	3,04	10
15 x 15	TQ 15X15 AS	Anodized	Silver	4,03	10
20 x 20	TQ 20X20 AS	Anodized	Silver	5,05	10
10 x 10	TQ 10X10 AO	Anodized	Gold	3,04	10
15 x 15	TQ 15X15 AO	Anodized	Gold	4,03	10
20 x 20	TQ 20X20 AO	Anodized	Gold	5,05	10
10 x 10	TQ 10X10 AB	Anodized	Bronze	3,04	10
15 x 15	TQ 15X15 AB	Anodized	Bronze	4,03	10
20 x 20	TQ 20X20 AB	Anodized	Bronze	5,05	10

profiles >> RE Rectangular in Anodized Aluminum- thickness = 1 mm

H = mm	Art.	Finish	Variant	€/ m	pc ■
20 x 10	RE 20X10 AS	Anodized	Silver	4,03	10
30 x 15	RE 30X15 AS	Anodized	Silver	5,18	10
20 x 10	RE 20X10 AO	Anodized	Gold	4,03	10
30 x 15	RE 30X15 AO	Anodized	Gold	5,18	10
20 x 10	RE 20X10 AB	Anodized	Bronze	4,03	10
30 x 15	RE 30X15 AB	Anodized	Bronze	5,18	10

profiles >> CDW profile in Anodized Aluminum- thickness = 1 mm

H = mm	Art.	Finish	Variant	€/ m	pc ■
16 x 12	CD 16X12 AS	Anodized	Silver	3,48	10
20 x 10	CD 20X10 AS	Anodized	Silver	3,48	10
16 x 12	CD 16X12 AO	Anodized	Gold	3,48	10
20 x 10	CD 20X10 AO	Anodized	Gold	3,48	10
16 x 12	CD 16X12 AB	Anodized	Bronze	3,48	10
20 x 10	CD 20X10 AB	Anodized	Bronze	3,48	10

profiles >> PT "T" profile in Anodized Aluminum- thickness = 1,5 mm

H = mm	Art.	Finish	Variant	€/ m	pc ■
15 x 15	PT 15X15 AS	Anodized	Silver	3,26	10
25 x 25	PT 25X25 AS	Anodized	Silver	4,66	10
15 x 15	PT 15X15 AO	Anodized	Gold	3,26	10
25 x 25	PT 25X25 AO	Anodized	Gold	4,66	10
15 x 15	PT 15X15 AB	Anodized	Bronze	3,26	10
25 x 25	PT 25X25 AB	Anodized	Bronze	4,66	10

profiles >> TO Ronde in Anodized Aluminum

H = mm	Art.	Finish	Variant	€/ m	pc ■
8	TO 8 AS	Anodized	Silver	3,65	10
8	TO 8 AO	Anodized	Gold	3,65	10
8	TO 8 AB	Anodized	Bronze	3,65	10

profiles >> QU Square in Anodized Aluminum

H = mm	Art.	Finish	Variant	€/ m	pc ■
8 x 8	QU 8 AS	Anodized	Silver	4,42	10
8 x 8	QU 8 AO	Anodized	Gold	4,42	10
8 x 8	QU 8 AB	Anodized	Bronze	4,42	10

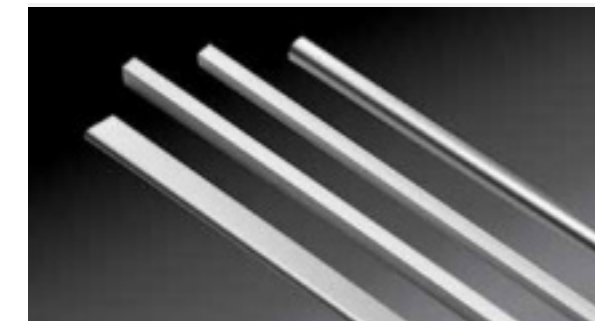

Silver



Gold



Bronze

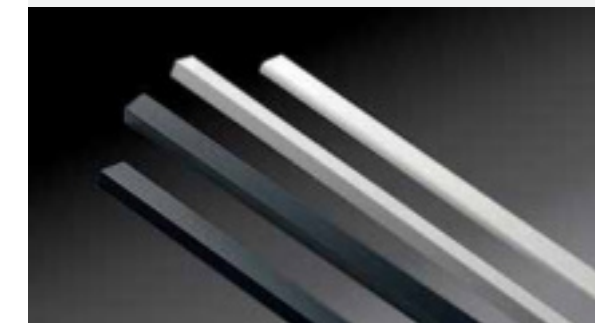

White and black

Length: 2,00 meters

Indivisible packaging

TOPLINE Cod. L+ €/m 3,99
Polished on request



PA-ON



PA-OL

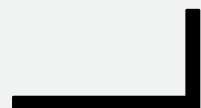

PL-OL



PA-P



PL-P

profiles >> PAP Equal angled section in Natural Brass - thickness = 1,5 mm

H = mm	Art.	Finish	€/ m	pc ■
15 x 15	PAP 15X15 ON	Natural	17,83	10
20 x 20	PAP 20X20 ON	Natural	23,86	10
25 x 25	PAP 25X25 ON	Natural	28,61	10
25 x 15	PAP 25X15 ON	Natural	27,78	10

profiles >> PA Equal angled section in Polished Brass - thickness = 1 mm

H = mm	Art.	Finish	€/ m	pc ■
15 x 15	PA 15X15 OL	Polished	13,18	10
20 x 20	PA 20X20 OL	Polished	17,02	10
25 x 25	PA 25X25 OL	Polished	21,10	10
30 x 30	PA 30X30 OL	Polished	26,37	10
35 x 35	PA 35X35 OL	Polished	29,82	10
40 x 40	PA 40X40 OL	Polished	34,55	10
50x 50	PA 50X50 OL	Polished	40,88	10

profiles >> PL "L" profile in Polished Brass - thickness = 1 mm

H = mm	Art.	Finish	€/ m	pc ■
15 x 10	PL 15X10 OL	Polished	11,10	10
20 x 10	PL 20X10 OL	Polished	13,18	10
30 x 15	PL 30X15 OL	Polished	19,55	10

profiles >> PA Equal angled section in PVC - thickness = 1,4 mm

H = mm	Art.	Finish	Variant	€/ m	pc ■
10 x 10	PA 10X10 P11	PVC	Pure White	1,83	10
15 x 15	PA 15X15 P11	PVC	Pure White	2,01	10
20 x 20	PA 20X20 P11	PVC	Pure White	2,30	10
25 x 25	PA 25X25 P11	PVC	Pure White	2,60	10
30 x 30	PA 30X30 P11	PVC	Pure White	2,86	10
10 x 10	PA 10X10 P63	PVC	Dark Brown	1,83	10
15 x 15	PA 15X15 P63	PVC	Dark Brown	2,01	10
20 x 20	PA 20X20 P63	PVC	Dark Brown	2,30	10
25 x 25	PA 25X25 P63	PVC	Dark Brown	2,60	10
30 x 30	PA 30X30 P63	PVC	Dark Brown	2,86	10

profiles >> PL "L" profile in PVC - thickness = 1,4 mm

H = mm	Art.	Finish	Variant	€/ m	pc ■
15 x 10	PL 15X10 P11	PVC	Pure White	1,99	10
20 x 10	PL 20X10 P11	PVC	Pure White	2,13	10
30 x 15	PL 30X15 P11	PVC	Pure White	2,51	10
15 x 10	PL 15X10 P63	PVC	Dark Brown	1,99	10
20 x 10	PL 20X10 P63	PVC	Dark Brown	2,13	10
30 x 15	PL 30X15 P63	PVC	Dark Brown	2,51	10

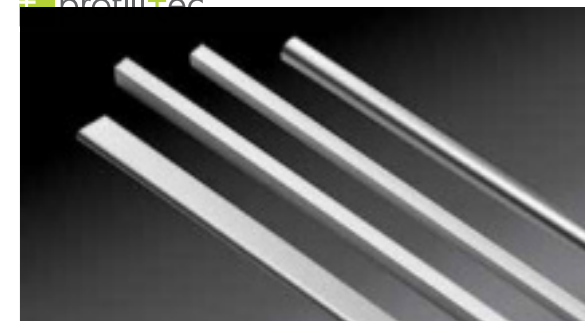

Silver



Gold

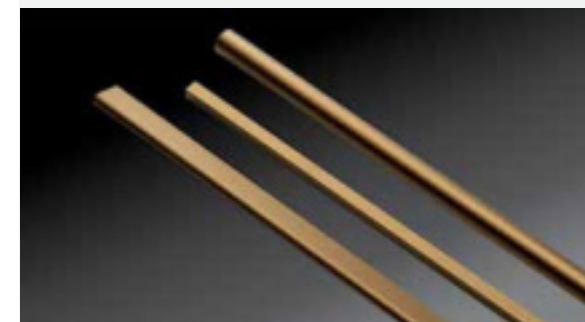

Bronze

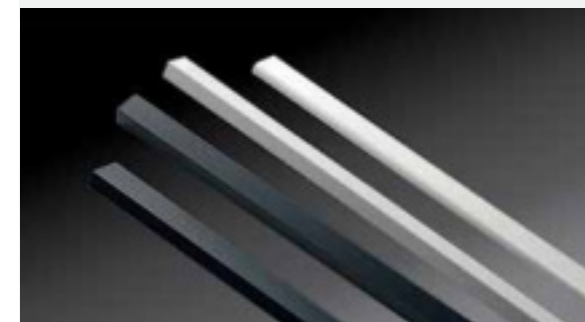

White and black





Tile installation accessories

This chapter presents all the products designed to facilitate the installation of floors. Leveltec is an innovative, patented installation system

that resolves the irritating problem of leveling tile, a need in increasing demand with the widespread use of large format tile. The system is composed of a reusable cap and tie-bases (also called fasteners), which guarantee the perfect distance between the tiles.

Uptec is a revolutionary installation system for raised floors. With only three elements, you can realize any floor height, and the vast range of accessories available make Uptec versatile and ideal for simple tile installations, joist installations with tile or decking, or even for the installation of wood planks on joists. For technical information and to discover all

the secrets of this amazing product, please request the Uptec manual.

A range of other supports is available for low raised floors.

Cross-shaped and T-shaped spacers can be used to achieve equally spaced tile joints.

Article	Code	Use	Pag.
Leveltec	LEV	levelling system	184
Uptec	SUPA*	Universal pedestals	188
Pedestal	SUPT	Adjustable	189
Pedestal	80-/set	supports for floating floor	189
Bordertec	BSR	for floating floors	190
Bordertec	BSJ	modular for terraces	191
Bordertec	BST	modular for terraces	191
Spacers	DIC	Cross-shaped spacers	192
Spacers	DIT	T-shaped spacers	192
Spacers	DISC		192
Tile spacers	DIS		192
Pesotec	PS	carpet and panel inspection	193
Magnets	MAG	carpet and panel inspection	193
Tools		magnets, screws and tools	193



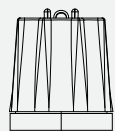

Cap assembled

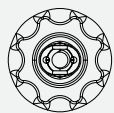

leveltec leveling system >> Screw leveling system just with a click

Art.	Finish	€ / cf	pck ■	€ / cf	pck ■
LEV / M	Automatic cap assembled	67,61	1	61,55	6

1 package (pkg) contains 50 pcs



Leveltec Cap



- + Reusable patented knob for tiles thicknesses from 3,5 to 20 mm
- + No tools required, no need to screw or unscrew.
- + Leveling system in one click only to eject the spacer.



Leveltec Tie-base



- + Patented tie-base for thicknesses of 1,2,3,5mm - (linear, "T" + "cross").
- + Removable spacing fins (for "T" and "cross" shaped spacers) Allow tiles to compensate movements
- + Base that allows an effective adhesive grip

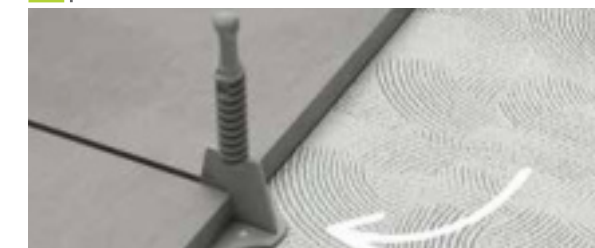

leveltec

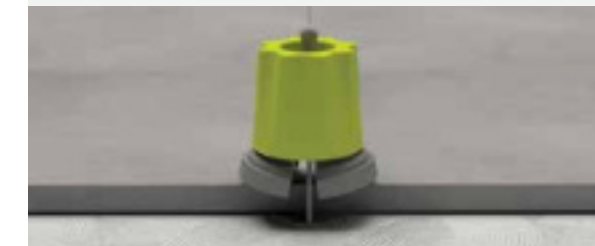

leveltec



leveltec



leveltec



leveltec



linear tie-base leveling

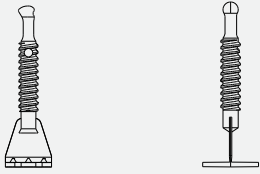

LEV/10 1 mm

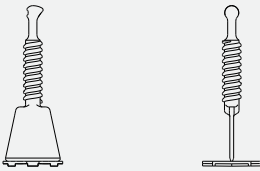

LEV/20 2 mm

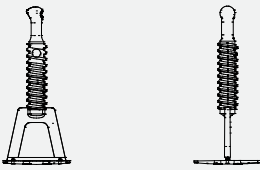

LEV/30 3 mm

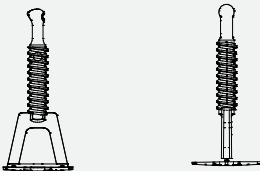

LEV/50 5 mm

leveltec laying system >> Linear tie-base

	Art.	Finish	€ / cf	pck ■	€ / cf	pck ■
	LEV / 10	Linear tie-base thickness 1 mm	47,03	1	43,97	10
	LEV / 20	Linear tie-base thickness 2 mm	48,51	1	43,97	10
	LEV / 30	Linear tie-base thickness 3 mm	49,98	1	46,89	10
	LEV / 50	Linear tie-base thickness 5 mm	52,92	1	49,83	10

1 package (pkg) contains 250 pcs



Linear tie-base

1 mm

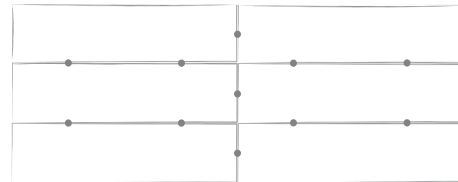
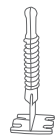

2 mm

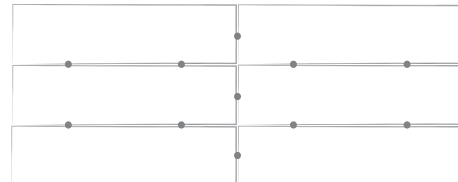
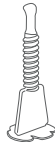

3 mm

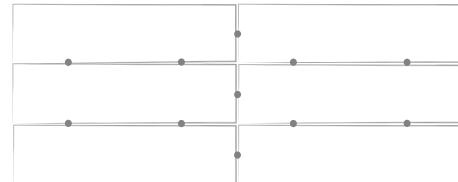

5 mm

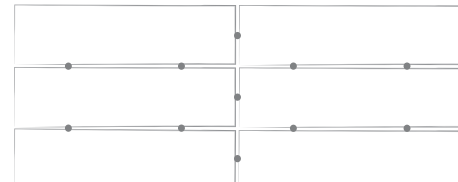

Patented linear tie-base. For stone and tile floors. in stone and ceramic



1, 2, 3, 5mm



Leveltec linear tie-base laying instructions

How many Leveltec tie-bases are required per square meter? The quantity of Leveltec depends on the size of the tile (AxB), see the table below: it can be deduced from the scheme

A (cm)	45	50	60	80	90	100	120
45	20						
50	18	16					
60	15	13	11				
80	14	12	10	9			
90	12	11	9	8	7		
100	13	12	10	9	8	8	
120	11	10	8	7	6	7	6
B (cm)	45	50	60	80	90	100	120

Indicative example of pieces consumption / m2

To optimize consumption, use the linear tie-base for large-format tile. tiles.



"T" tie-base leveling

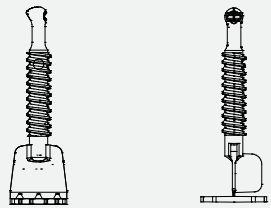

LEV/10T 1 mm

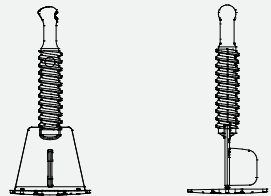

LEV/20T 2 mm

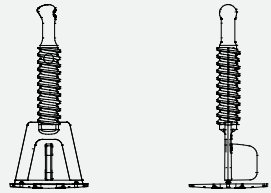

LEV/30T 3 mm

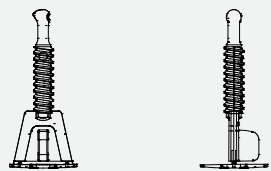

LEV/50T 5 mm

leveltec laying system >> "T" tie-base

	Art.	Finish	€ / cf	pck ■	€ / cf	pck ■
LEV	/ 10T	"T" tie-base thickness 1 mm	49,98	1	46,89	10
LEV	/ 20T	"T" tie-base thickness 2mm	49,98	1	46,89	10
LEV	/ 30T	"T" tie-base thickness 3 mm	52,92	1	49,83	10
LEV	/ 50T	"T" tie-base thickness 5 mm	55,85	1	52,76	10

1 package (pkg) contains 250 pcs



1 mm

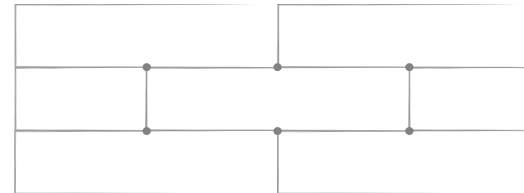
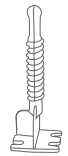

2 mm

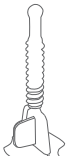

3 mm

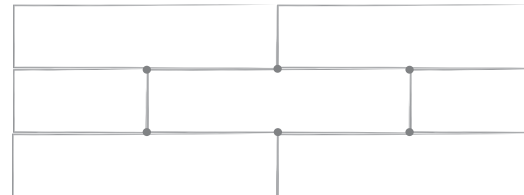
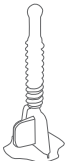

5 mm

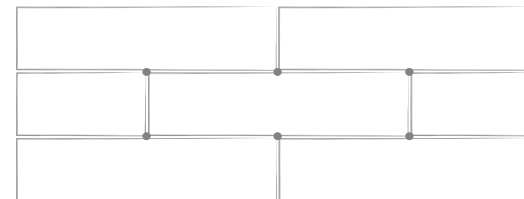

"T" tie-base leveling

Patented "T" tie-base. For straight course laying.

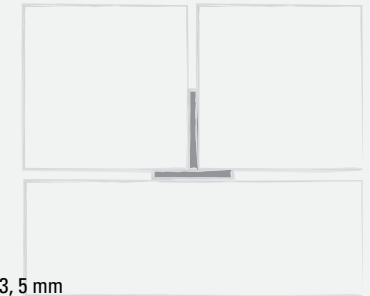

1, 2, 3, 5 mm

Leveltec "T" tie-base laying instructions

How many Leveltec tie-bases are required per square meter? The quantity of Leveltec depends on the size of the see the table below: Patented "T" tie-base.

A (cm)					
12	23	21	19	17	14
15	19	17	15	14	11
20	14	13	11	10	9
B (cm)	60	80	90	100	120

Indicative example of pieces consumption / m2

To optimize consumption, use the linear tie-base for large-format tile. tiles.

cross laying

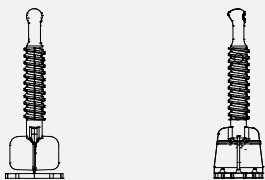

LEV/10C 1 mm

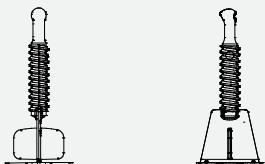

LEV/20C 2 mm



LEV/30C 3 mm

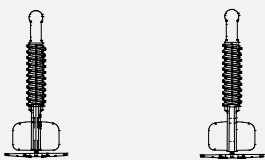

LEV/50C 5 mm

leveltec laying system >> cross tie-base

Art.	Finish	€ / cf	pck ■	€ / cf	pck ■
LEV / 10C	Cross tie-base thickness 1 mm	49,98	1	46,89	10
LEV / 20C	Cross tie-base thickness 2mm	49,98	1	46,89	10
LEV / 30C	Cross tie-base thickness 3 mm	52,92	1	49,83	10
LEV / 50C	Cross tie-base thickness 5 mm	55,85	1	52,76	10

1 package (pkg) contains 250 pcs



Cross tie-base leveling

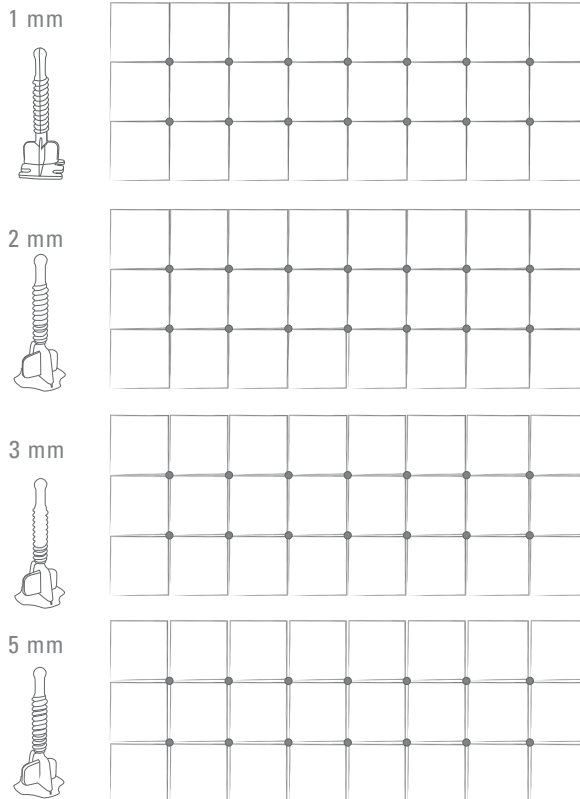

Notes about consumption of tie-base for mixed configurations

It is possible to use mixed or customized configurations that allow a significant decrease of the consumption. but for which we can not guarantee a correct tile leveling.

Patented cross tie-base. Complete removable wings. after laying

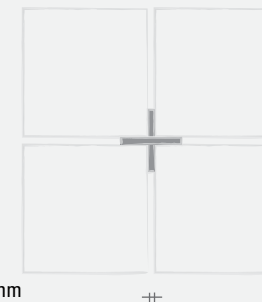

1, 2, 3, 5 mm

Leveltec cross tie-base laying instructions
How many Leveltec tie-bases are required per square meter? The quantity of Leveltec depends on the size of the tile (AxB) and it can be deduced from scheme below.

A (cm)	20	25	17	15	12
30	17	11	10	9	
33	15	10	9	8	
40	12	9	8	6	
B (cm)	20	30	33	40	

Indicative example of pieces consumption / m2
To optimize consumption, use the linear tie-base for large-format tile. tiles.

cm	Cross tie-base +	Linear tie-base —	TOT.
45x45	5		5
60x60	3		3
80x80	2	3	2
30x60	6		6
45x90	3	3	6
120x60	2	2	4



PEDESTALS

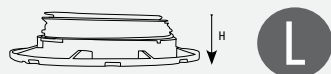

SUPAL



SUPAS



SUPAR

ACCESSORIES

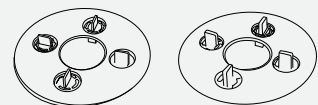

SUPA2

SUPA4

B = tab thickness

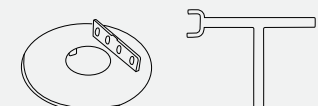

SUPAW

SUPAK

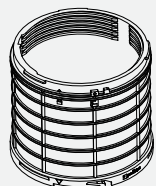

SUPAR120

uptec >> adjustable universal pedestals for raised floors - components

H = mm	Art.	Finish	€ / pc	pck ■
28 / 43	SUPAL	Low pedestal	4,20	24 pcs
43 / 58	SUPAS	Standard pedestal	4,39	24 pcs
30	SUPAR	Modular Ring	0,88	24 pcs

uptec >> accessories

Art.	Finish	€ / pc	pck ■
SUPA2	spacer - 2 mm tabs	1,53	240 pcs
SUPA4	Spacer - 4 mm tabs - also compatible with Al. joists	1,53	240 pcs
SUPAW	spacer - wooden joints	1,53	240 pcs
SUPAR 120	Big ring	2,63	24 pcs
SUPAK	3 functions adjusting key	72,69	1 pc

28÷43 mm	43÷58 mm	58÷88 mm	88÷118 mm	118÷148 mm
SUPAL	SUPAS	SUPAS + 1 SUPAR	SUPAS + 2 SUPAR	SUPAS + 3 SUPAR

uptec >> KIT pedestal with 2 mm tabs - assembled product

H = mm	Art.	Finish	€ / pc	pck ■
28 / 43	SUPAL2- 28/43	kit pedestal + 2 mm spacer tabs	6,37	24 pcs
43 / 58	SUPAS2- 43/58	kit pedestal + 2 mm spacer tabs	6,58	24 pcs
58 / 88	SUPAS2- 58/88	kit pedestal + 2 mm spacer tabs	7,56	24 pcs
88 / 118	SUPAS2- 88/118	kit pedestal + 2 mm spacer tabs	8,53	24 pcs
118 / 148	SUPAS2- 118/148	kit pedestal + 2 mm spacer tabs	9,51	24 pcs

uptec >> KIT pedestal with 4 mm tabs - assembled product

H = mm	Art.	Finish	€ / pc	pck ■
28 / 43	SUPAL4- 28/43	kit pedestal + 4 mm spacer tabs	6,37	24 pcs
43 / 58	SUPAS4- 43/58	kit pedestal + 4 mm spacer tabs	6,58	24 pcs
58 / 88	SUPAS4- 58/88	kit pedestal + 4 mm spacer tabs	7,56	24 pcs
88 / 118	SUPAS4- 88/118	kit pedestal + 4 mm spacer tabs	8,53	24 pcs
118 / 148	SUPAS4- 118/148	kit pedestal + 4 mm spacer tabs	9,51	24 pcs

pkg = indivisible packaging



SUPG SUPD
 SUPAJ SUPCLIP
 SUPACLPB SUPACLPT
 SUPACLPP SUPAAN
 SUPATG

uptec >> additional accessories					
	H = mm	Art.	Finish	€ / pc	pck ■
new	2	SUPL 2	Levelling disk	0,59	600 pcs
new	3	SUPL 3	Levelling disk	0,64	500 pcs
new	198 / 198	SUPATG	Rubber mat	1,22	24 pcs
		SUPG	Anti noise rubber (rol. 10 m)	17,16	1 rol
		SUPD	spacer thickness 4 mm	0,22	500 pcs
		SUPCLIP	Lateral and central clip	0,83	50 pcs
		SUPACLPB	Clip for vertical edge - base	7,92	5 pcs
		SUPACLPT	Clip for vertical edge - head	9,39	5 pcs
		SUPACLPP	Perimeter spacer	3,77	5 pcs
		SUPAJ	Junctions for Aluminum joists	0,95	20 pz
				€ / m	pc ■
		SUPAAN 240	Natural Aluminum Joist L: 2,40 m	16,30	10 pcs



SUPT



support 8010/set



support 8020/set



SUPT SUPB

support >> SUPT Adjustable support					
	H = mm	Art.	Finish	€ / pc	pck ■
	10 / 15	SUPT	Adjustable support - 2 mm tabs	1,54	50 pcs
	10 / 15	SUPT4	Adjustable support - 4 mm tabs	1,54	50 pcs

support >> SUPB - SUPT extension					
	H = mm	Art.	Finish	€ / pc	pck ■
	5	SUPB	Extension for SUPT	0,83	50 pcs

maximum height 25 mm; stackable product.

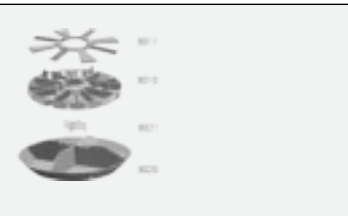

Plastic support » for floating stone tiles					
	H = mm	Art.	Finish	€ / cf	pck ■
	3	8011 / set	Polypropylene thickness	24,96	100 pcs
	13	8010 / set	Polypropylene support	118,36	250 pcs
	3	8021 / set	Cross spacers	27,54	200 pcs
	20	8020 / set	Polypropylene support	51,64	50 pcs

pkg = indivisible packaging

adjustable universal pedestals

accessories



Length: 2,70 meters

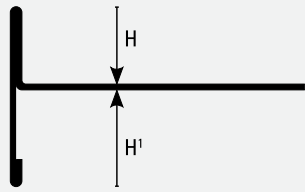

BSR - A

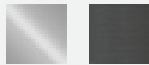

A22 A50

The images are inserted purely for illustrative purposes

bordertec >> BSR Terminal profile in Powder Coated Aluminum

H/H1 = mm	Art.			Finish	Variant	€ / m	pc ■
20/40	BSR	20/40	A22	Pow. Coated	Pastel Grey	25,97	5
20/60	BSR	20/60	A22	Pow. Coated	Pastel Grey	28,61	5
20/80	BSR	20/80	A22	Pow. Coated	Pastel Grey	32,14	5
20/100	BSR	20/100	A22	Pow. Coated	Pastel Grey	36,58	5

bordertec >> BSRE External corner in Powder Coated Aluminum

H/H1 = mm	Art.			Finish	Variant	€ / pc	pc ■
20/40	BSRE	20/40	A22	Pow. Coated	Pastel Grey	35,92	10
20/60	BSRE	20/60	A22	Pow. Coated	Pastel Grey	39,59	10
20/80	BSRE	20/80	A22	Pow. Coated	Pastel Grey	44,46	10
20/100	BSRE	20/100	A22	Pow. Coated	Pastel Grey	50,57	10

bordertec >> BSRG Joint in Powder Coated Aluminum

H/H1 = mm	Art.			Finish	Variant	€ / pc	pc ■
20/40	BSRG	20/40	A22	Pow. Coated	Pastel Grey	7,14	10
20/60	BSRG	20/60	A22	Pow. Coated	Pastel Grey	7,87	10
20/80	BSRG	20/80	A22	Pow. Coated	Pastel Grey	8,84	10
20/100	BSRG	20/100	A22	Pow. Coated	Pastel Grey	10,09	10

bordertec >> BSR Terminal profile in Powder Coated Aluminum Modern Line

H/H1 = mm	Art.			Finish	Variant	€ / m	pc ■
20/40	BSR	20/40	A50	Pow. Coated	Embossed Micaceous	25,97	5
20/60	BSR	20/60	A50	Pow. Coated	Embossed Micaceous	28,61	5
20/80	BSR	20/80	A50	Pow. Coated	Embossed Micaceous	32,14	5
20/100	BSR	20/100	A50	Pow. Coated	Embossed Micaceous	36,58	5

bordertec >> BSRE External corner in Powder Coated Aluminum Modern Line

H/H1 = mm	Art.			Finish	Variant	€ / pc	pc ■
20/40	BSRE	20/40	A50	Pow. Coated	Embossed Micaceous	35,92	10
20/60	BSRE	20/60	A50	Pow. Coated	Embossed Micaceous	39,59	10
20/80	BSRE	20/80	A50	Pow. Coated	Embossed Micaceous	44,46	10
20/100	BSRE	20/100	A50	Pow. Coated	Embossed Micaceous	50,57	10

bordertec >> BSRG Joint in Powder Coated Aluminum Modern Line

H/H1 = mm	Art.			Finish	Variant	€ / pc	pc ■
20/40	BSRG	20/40	A50	Pow. Coated	Embossed Micaceous	7,14	10
20/60	BSRG	20/60	A50	Pow. Coated	Embossed Micaceous	7,87	10
20/80	BSRG	20/80	A50	Pow. Coated	Embossed Micaceous	8,84	10
20/100	BSRG	20/100	A50	Pow. Coated	Embossed Micaceous	10,09	10



bordertec BSR 20/100 A50

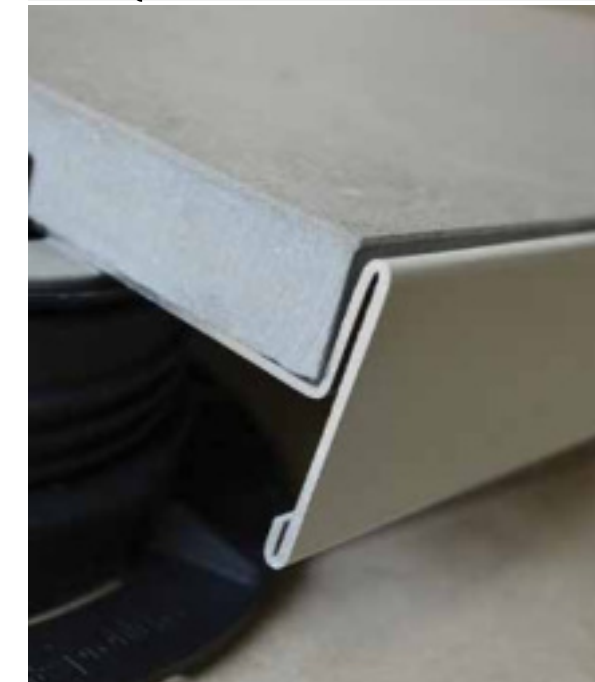

bordertec BSR 20/40 A22

⊗ For quantities below 10 pcs 10% price increase applied.



Length: 2,70 meters

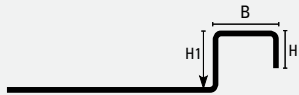

BSJ 20 *

H1 = 20 mm

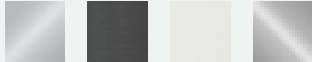

IS A50 A13 A22



A65

The images are inserted purely for illustrative purposes

bordertec >> BSJ in Stainless Steel AISI 304 - DIN 1.4301 - Brushed

BxH = mm	Art.	Finish	€ / m	pc ■
20 x 12	BSJ 20 IS	Brushed	39,23	10

bordertec >> BSJE External corner in Stainless Steel AISI 304 - DIN 1.4301 - Brushed

B = mm	Art.	Finish	€ / pc	pc ■
20	BSJE 20 IS	Brushed	49,78	10

bordertec >> BSJ in Power Coated Aluminum

BxH = mm	Art.	Finish	Variant	€ / m	pc ■
20 x 12	BSJ 20 A50	Pow. Coated	Embossed Micaceous	21,21	10
new	20 x 12 BSJ 20 A13	Pow. Coated	Embossed Antique White	21,21	10
new	20 x 12 BSJ 20 A22	Pow. Coated	Pastel Grey	21,21	10
new	20 x 12 BSJ 20 A65	Pow. Coated	Embossed matt Black	21,21	10

bordertec >> BSJE External Junction in Power Coated Aluminum

B = mm	Art.	Finish	Variant	€ / pc	pc ■
20	BSJE 20 A50	Pow. Coated	Embossed Micaceous	33,58	10
20	BSJE 20 A13	Pow. Coated	Antique White	33,58	10
20	BSJE 20 A22	Pow. Coated	Pastel Grey	33,58	10
20	BSJE 20 A65	Pow. Coated	Embossed matt Black	33,58	10

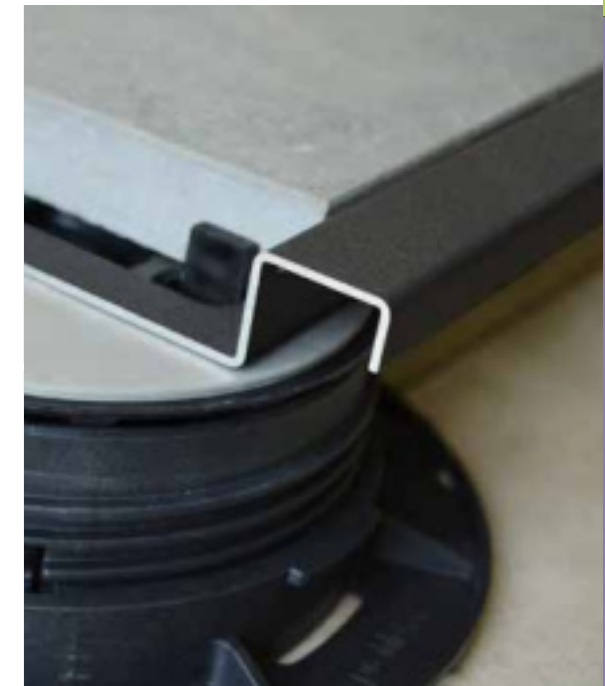

bordertec BSJ 20 A65

Length: 2,70 meters

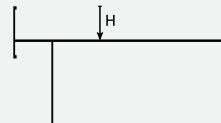

BST 20 A*

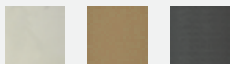

A24 A33 A50

The images are inserted purely for illustrative purposes

bordertec >> BST in Powder Coated Aluminum Modern Line

H = mm	Art.	Finish	Variant	€ / m	pc ■
new	20 BST 20 A24	Pow. Coated	Embossed Micaceous	36,14	5
new	20 BST 20 A33	Pow. Coated	Embossed Micaceous	36,14	5
new	20 BST 20 A50	Pow. Coated	Embossed Micaceous	36,14	5

bordertec >> BSTE Joint in Powder Coated Aluminum Modern Line

H = mm	Art.	Finish	Variant	€ / pc	set ■
new	20 BSTE 20 A24	Pow. Coated	Embossed Micaceous	49,93	10
new	20 BSTE 20 A33	Pow. Coated	Embossed Micaceous	49,93	10
new	20 BSTE 20 A50	Pow. Coated	Embossed Micaceous	49,93	10



bordertec BST 20 A50

☒ For quantities below 10 pcs 10% price increase applied.

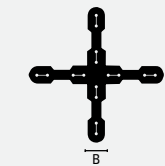

DIC

tile spacers » DIC cross-shaped

B = mm	DIC	Art.	Finish	€ / set	set ■
1	DIC	10	Polypropylene	4,76	1
1,5	DIC	15	Polypropylene	4,79	1
2	DIC	20	Polypropylene	4,81	1
3	DIC	30	Polypropylene	5,52	1
4	DIC	40	Polypropylene	5,77	1
5	DIC	50	Polypropylene	6,14	1
7	DIC	70	Polypropylene	9,73	1
10	DIC	100	Polypropylene	16,36	1

1 set = 500 pz
Self-service boxes for showrooms.



tile spacers

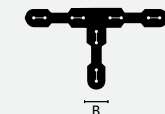

DIT

tile spacers » DIT "T"-shaped

B = mm	DIT	Art.	Finish	€ / set	set ■
1	DIT	10	Polypropylene	4,76	1
2	DIT	20	Polypropylene	4,81	1
3	DIT	30	Polypropylene	5,52	1
4	DIT	40	Polypropylene	5,77	1
5	DIT	50	Polypropylene	6,14	1
7	DIT	70	Polypropylene	9,73	1
10	DIT	100	Polypropylene	16,36	1

1 set = 500 pz
Self-service boxes for showrooms.



Self Service Box

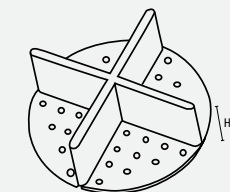

DISC 10

tile spacers » DISC spacer thickness 3 mm

H = mm	DISC	Art.	Finish	€ / pc	pc ■
10	DISC	10	ABS	0,99	100



tile spacer DISC



DIS 50

tile spacers » DIS

H = mm	DIS	Art.	Finish	€ / set	set ■
5	DIS	50	Polypropylene	5,52	1

Self-service boxes for showrooms.



Length: 2,00 and 4,00 meters

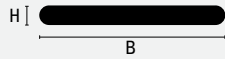

PS 30 AN

entrytec >> Aluminum weight for curtains

HxB = mm	Art.	Finish	€ / m	pc ■
4 x 30	PS 30 AN	Natural	7,39	10

magnets » for tiled wall-panel inspection - 4 magnets + 4 plates

Art.	Finish	Variant	€ / set	set ■
MAG	Anodized	Silver + magnets	11,25	4

screws » For threshold covers and baseboard

mm	Art.	Finish	€ / set	set ■
3 x 35	4481 set /	Brassed flat screw	12,54	200 pcs
3 x 35	4482 set /	Chromed flat screw	12,54	200 pcs
3 x 35	4483 set /	Bronzed flat screw	12,54	200 pcs

dowels » For threshold covers and baseboard

mm	Art.	Finish	€ / set	set ■
5 x 25	4484 set /	Nylon dowel	6,97	200 pcs

scissors » for PVC profile

Art.	Finish	€ / pc	pc ■
2643 / /	scissors	87,64	1



magnets MAG

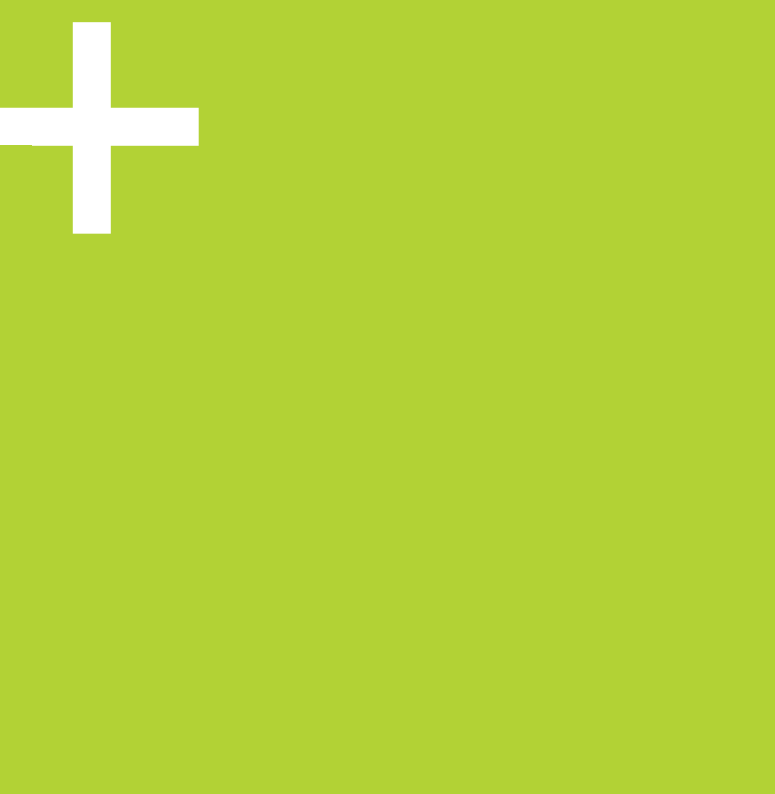

Marketing

Marketing materials for clients and large distributors. Shelf and table displays showcase each product range.

Price lists, catalogs, brochures and technical manuals are collected in our library, ready to explain the details of all our products.

A series of binders and cardboard holders for each product range contain samples that can be inserted and showcased in a Wood Totem display. A Table Display line can also be personalized in the Profilitec Metal Totem.

The marketing material also includes small cardboard displays with profiles samples divided by product range. Use all this and more to display Profilitec products.

Article	Pag.
Display	196
documentation	197
Totem	198
Samples	199





Professional Display

Professional Display >> Division for Family Product

cm	Art.			Finish	€ / pc
124 x 47 x 270	DISPSTD_	GEN/	IT-GB	General	271,68
124 x 47 x 270	DISPSTD_	GEN/	FR-DE	General	271,68
33	DISPSTD_	KIT	DIV	Kit of 10 dividing bars	5,72
124 x 45	DISPSTD_	KIT	BAS	Membrane stocking shelf	46,41



DISPSTD_GEN



Table Display Leveltec

Table Display

			Art.	Finish	€ / pc
	ESP-	LEV		Table Display Leveltec + depliant	5,72
	ESP-	STC/	ENFRES	Table Display Showertec	15,44
	ESP-	UPT/	ITENFRDEES	Table Display Uptec	13,15



ESP-LEV + TDIS_LIS



Table Display Uptec



Price List

Price List >> Price List Profiltec

		Art.		Finish	€ / pc
		LIST	21 IT	Price List Italian	3,43
		LIST	21 EN	Price List English	3,43
		LIST	21 FR	Price List French	3,43
		LIST	21 DE	Price List German	3,43
		LIST	21 US	Price List United States	3,43
		LIST	21 CAN	Price List Canada	3,43

Illustrative Book

		Art.		Finish	€ / pc
		BOOK	UPT/ ITENDE	Illustrative Book Uptec	0,91
		BOOK	UPT/ ENFRES	Illustrative Book Uptec	0,91
new		BOOK	STL EU	Showertec Linear Book	4,11
new		BOOK	STL US	Showertec Linear Book	4,11

Technical Manual

		Art.		Finish	€ / pc
		MAN_	UPT19 ITENDE	Technical Manual Uptec	1,72
		MAN_	UPT19 ENFRES	Technical Manual Uptec	1,72
		MAN_	STC 00	Technical Manual Showertec	1,72

Illustrative Brochure

H = mm		Art.		Finish	€ / m
21 x 29,7	BRO-	APP15/	FRDE	Illustrative Brochure Appendo	0,57
21 x 29,7	BRO-	BATT15/	FRDE	Illustrative Brochure Baseboard	0,57
21 x 29,7	BRO-	BORDER15/	FRDE	Illustrative Brochure border	0,57
21 x 29,7	BRO-	GLITTER15/	FRDE	Illustrative Brochure Glitter	0,57
21 x 29,7	BRO-	PARA15/	FRDE	Illustrative Brochure Stair nosing	0,57
21 x 29,7	BRO-	LEV/	ITENFRDE	Illustrative Brochure Leveltec	0,57
21 x 29,7	BRO-	STC/	ENFRDE/P	Illustrative Brochure Showertec	0,57
21 x 29,7	BRO-	WMOD/	ITENFRDE	Illustrative Brochure Wall modern line	0,57
21 x 29,7	BRO-	LVT/	ITENFRDE	Illustrative Brochure LVT	0,57
21 x 29,7	BRO-	FLO/	ITENFRDE	Illustrative Brochure Floortec	0,57
21 x 29,7	BRO-	-JOI/	ITENFRDEES	Illustrative Brochure joints	0,57
21 x 29,7	BRO-	MUD/	ITENFRESEDE	Illustrative Brochure MUD - MUDR	0,57
21 x 29,7	BRO-	BAS/	ITENFRDEES	Illustrative Brochure Baseboards	0,57
21 x 29,7	BRO-	STL	EU	Showertec Linear Brochure	0,57
21 x 29,7	BRO-	STL	US	Showertec Linear Brochure	0,57
21 x 29,7	PIEG	LEV/	ITENFRDEES	Illustrative brochure Leveltec	0,57
21 x 29,7	BRO-	UPT/	IT	Illustrative Brochure Uptec	0,57
21 x 29,7	BRO-	UPT/	ENUS	Illustrative Brochure Uptec	0,57
21 x 29,7	BRO-	UPT/	FR	Illustrative Brochure Uptec	0,57
21 x 29,7	BRO-	UPT/	DE	Illustrative Brochure Uptec	0,57
21 x 29,7	BRO-	UPT/	ES	Illustrative Brochure Uptec	0,57



BOOK STL



Technical Manual



Brochure



Illustrative Brochure



Set dox

Set Dox

cm	Art.		Finish	€ / pc
33,5 x 26,7 x 7,5	DOX	CAT11	DOX Documentation	13,15
33,5 x 26,7 x 7,5	DOX	FIN11	DOX Finishes	13,15
33,5 x 26,7 x 7,5	DOX	PAV112	DOX Ceramic floors	13,15
33,5 x 26,7 x 7,5	DOX	WOOD12	DOX Wooden floors	13,15
33,5 x 26,7 x 7,5	DOX	GRAD12	DOX Stair nosing	13,15
33,5 x 26,7 x 7,5	DOX	RIVE12	DOX Wall coverings	13,15
33,5 x 26,7 x 7,5	DOX	GIUN12	DOX Movement joints	13,15
33,5 x 26,7 x 7,5	DOX	STRUT12	DOX Structural Joints	13,15
33,5 x 26,7 x 7,5	DOX	BALC12	DOX Terraces	13,15
33,5 x 26,7 x 7,5	DOX	BATT12	DOX Baseboard	13,15
33,5 x 26,7 x 7,5	DOX	GEN12	DOX General	13,15
33,5 x 26,7 x 7,5	DOX	SHOWER18/ ENFRES	DOX Showertec	13,15



DOX



Table Display

Totem » Showroom - totem in metal

cm	Art.		Finish	€ / pc
35 x 42 x 170	DISP_	TDIS	Totem in metal	22,87

Table Display

cm	Art.		Finish	€ / pc
33,5 x 39,5	TDIS_	FIN1	Table Display Metal	11,44
33,5 x 39,5	TDIS_	FIN2	Table Display Color	11,44
33,5 x 39,5	TDIS_	LIS	Table Display Listello	11,44
33,5 x 39,5	TDIS_	BATT	Table Display Baseboard	11,44
33,5 x 39,5	TDIS_	BOR	Table Display Border	11,44

totem

marketing



Table Display Leveltec

Display » Leveltec Display

	Art.		Finish	€ / pc
	DISP_	LEV00	Table Display Leveltec	68,79



DISP_TDIS + TDIS_FIN2



Mididox

Mididox

	cm	Art.			Finish	€ / m
	14,5 x 29,7	MIDI	LVT18	ITENFRDE	Mididox LVT	6,86
	14,5 x 29,7	MIDI	FLO18	ITENFRDE	Mididox Floortec	6,86
	14,5 x 29,7	MIDI	BAT19	ITENFRDE	Mididox Baseboards	6,86
	14,5 x 29,7	MIDI	RJF19	ITENFRDE	Mididox RJF	6,86
	14,5 x 29,7	MIDI	JOIN19	ITENFRDE	Mididox Joints	6,86
new	14,5 x 29,7	MIDI	STL	EN	Mididox STL	21,16



CHAIN

Samples » Color Swatches

		Art.			Finish	€ / pc
		RJ-	COLORI-	A12	Color swatches samples RJ - Aluminum	38,95
		RJ-	COLORI-	P12	Color samples RJ - PVC	11,55
		MULTICLIP-	FIN12		Samples Multiclip	41,50
		MULTICLIP	SAMPLES		Multiclip samples in anodized aluminum	6,43
		CHAIN	FLOOR		Samples floor coverings	12,01
		CHAIN	STAIRS		Samples stair nosing	6,29
		CHAIN	WALL		Samples wall coverings	13,73
		CHAIN	JOINTS		Samples joints	6,86
		CHAIN	MARBLE		Samples marble	5,72
new		CHAIN	STL		Cover metal STL samples	11,74
new		CHAIN	MODERNLINE		Modern Line finishes samples	8,63
		BORDER-	COL15		Samples border	22,30



Color samples RJ - marble

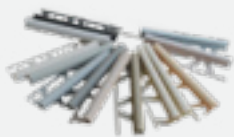

Color swatches PVC



totem

marketing

Sample box

mm	Art.		Finish	€ / pc
9,5 x 13	SEC/	LEV	Sample box Leveltec	5,88
9,5 x 13	SEC		Sample box	3,43



Samples

Code	Family	Product	Use	Pag.
AD	Floor covering profiles	Linotec	Separation	20
AE	Stair nosing profiles	Stairtec	Ribbed edge	56
APP 15	Wall covering profiles	Appendo	Hook	93
AV-AP-SC	Floor covering profiles	Linotec	PVC floors edge	41
BA400	Baseboards and wall protection rails	Baseboard	Minimal	152
BA600	Baseboards and wall protection rails	Baseboard	Standard	148
BA700	Baseboards and wall protection rails	Baseboard	Standard	151
BA-IL/IS	Baseboards and wall protection rails	Baseboard	Standard	148
Bandtec	Tile installation membranes	Bandtec	Waterproof Strip	146
BAR	Baseboards and wall protection rails	Baseboard	Decorative	148
BAS800	Baseboards and wall protection rails	Baseboard	minimal	152
BBS/BCS	Perimeter profiles for balconies	Bordertec	Perimeter Drainage	127
BBO/BCO	Perimeter profiles for balconies	Bordertec	Perimeter Drainage	131
BBR	Perimeter profiles for balconies	Bordertec	Perimeter Drainage	137
BD	Perimeter profiles for balconies	Bordertec	Multi-purpose perimeter	126
BD20	Perimeter profiles for balconies	Bordertec	Perimeter joint for terraces 2 cm	132
BDC	Perimeter profiles for balconies	Bordertec	Multi-purpose perimeter	126
BF	Baseboards and wall protection rails	Plano	Integrated	155
BFW	Baseboards and wall protection rails	Plano	Drywall	156
BFZ	Baseboards and wall protection rails	Baseboard	structural	156
BHO	Perimeter profiles for balconies	Bordertec	Perimeter joint for terraces 2 cm	132
BHS	Perimeter profiles for balconies	Bordertec	Perimeter joint for terraces 2 cm	132
BIB/BIM	Baseboards and wall protection rails	Baseboard	bicolor - design	153/154
BI	Baseboards and wall protection rails	Baseboard	Internal Channel	153
BO	Perimeter profiles for balconies	Bordertec	Perimeter trim	133
BOS	Perimeter profiles for balconies	Bordertec	Perimeter drainage	134
BP	Wall covering profiles	Planotec	Countertop	90
BR	Perimeter profiles for balconies	Bordertec	Edge	136
BSR	Floor covering profiles	Bordertec	Contour	10
BSR	Tile installation accessories	Bordertec	Profiles for elevated floors	188
BSR	Perimeter profiles for balconies	Bordertec	End cap	138
BT	Wall covering profiles	Baseboard	Mosaic	89
BT	Baseboards and wall protection rails	Baseboard	Thin-set	154
BTR	Perimeter profiles for balconies	Bordertec	modular	137
BSJ	Stair nosing profiles	Stairtec	non-slip	48
BSJ	Perimeter profiles for balconies	Bordertec	modular	136
BSJ	Tile installation accessories	Bordertec	modular	189

Code	Family	Product	Use	Pag.
BU	Floor covering profiles	Entrytec	Entrance mat	42
CA-CAJ	Movement joints profiles	Coflex	Thin-set	106/107
CAJP	Movement joints profiles	Coflex	Invisible	107
CB	Movement joints profiles	Coflex	Replaceable Insert	111
CBL	Movement joints profiles	Coflex	Replaceable Insert	112
CBR	Movement joints profiles	Coflex	Replaceable Insert	111
CD	Movement joints profiles	Coflex	Modular	114
CE	Movement joints profiles	Coflex	Thin-set	106
CF	Movement joints profiles	Coflex	Separation deep bed	114
CGD/CFD/CBD	Floor covering profiles	Carpetec	Carpet edge	40
CK	Movement joints profiles	Coflex	Technical	112
CKM	Movement joints profiles	Coflex	Mortar bed	113
C* Multiclip	Floor covering profiles	Multiclip®	Clip system	30
C* Multiclip LVT	Floor covering profiles	Multiclip® LVT	LVT clip system	33
CLF	Floor covering profiles	Multiclip®	Multiclip	31/34
CLG	Floor covering profiles	Multifix	Multifix	35
CLP	Floor covering profiles	Multiclip®	Multiclip perimeter	32/34
CLS	Floor covering profiles	Multiclip®	Multiclip Stair nosing profiles	60
CM	Movement joints profiles	Coflex	Modular	113
CMB	Movement joints profiles	Coflex	Modular	113
CO	Wall covering profiles	KeraCorner	Corner guard	96
CP	Movement joints profiles	Copritec	Modular	124
CPM	Movement joints profiles	Copritec	Modular	123
CPML/CPMP	Movement joints profiles	Jointec	Joint	123
CR	Wall covering profiles	Coflex	Internal cove	102
CR	Movement joints profiles	Coflex	corner joint	115
CRM - BT	Wall covering profiles	CRM - BT	Mosaic	89
CT	Movement joints profiles	Coflex	Grindable joint	110
CTL	Movement joints profiles	Coflex	Grindable	108
CTM	Movement joints profiles	Coflex	Grindable joint	114
CTR	Movement joints profiles	Coflex	Grindable	110
CU-FI	Floor covering profiles	Cubetec	Joint	15
DC	Floor covering profiles	Variotec	Transition	28
DIC-DIT	Tile installation accessories	Spacers	Spacers	190
DR/DS	Floor covering profiles	Variotec	Edge strip	29
DIS	Tile installation accessories	Spacers	thickness	190
DISC10	Tile installation accessories	Spacers	External spacers	190

Code	Family	Product	Use	Pag.
DK	Floor covering profiles	Variotec	Transition	28
Draintec 8/8S	Tile installation membranes	Draintec	Drainage	145
EP / EP60	Floor covering profiles	Covertec	Joint	15/16
ER	Wall covering profiles	Sanitec	Resin cove	102
FI	Stair nosing profiles	Stairtec	Non-slip trim	46
FL-AS	Stair nosing profiles	Stairtec	Decorative for ceramic	49
FL-IL	Stair nosing profiles	Stairtec	Decorative Stainless Steel	48
Floortec	Tile installation membranes	Floortec	uncoupling	144
FO	Stair nosing profiles	Stairtec	Non-slip technical	54/55
Foiltec	Tile installation membranes	Foiltec	Waterproofing/Uncoupling	142
FS	Stair nosing profiles	Stairtec	Non-slip trim	44
FSF	Stair nosing profiles	Stairtec	Non-slip trim	46
FSL	Stair nosing profiles	Stairtec	Non-slip edge	45
FVT	Stair nosing profiles	Stairtec	Non-slip edge	48
FW	Stair nosing profiles	Stairtec	Wood for ceramic	47
GA	Movement joints profiles	Jointec	Structural	118
GAD/GALD	Movement joints profiles	Jointec	Structural joint cover	119
GADP	Movement joints profiles	Jointec	Perimeter Structural Joint Cover	119
GAL/GALP	Movement joints profiles	Jointec	Structural	119
GAP	Movement joints profiles	Jointec	Structural	118
GAS	Movement joints profiles	Jointec	structural	119
GC/GCP/GCR	Movement joints profiles	Jointec	Concrete floors	124
GD/GDL	Movement joints profiles	Jointec	Structural joint cover	122
GDM	Movement joints profiles	Jointec	Structural joint cover	122
GDP/GDLP	Movement joints profiles	Jointec	Perimeter	121
GE/GEL	Movement joints profiles	Jointec	Structural	116
GEP/GELP	Movement joints profiles	Jointec	Perimeter modular	121
GH	Movement joints profiles	Jointec	Sliding structural	120
GI-GIL	Movement joints profiles	Jointec	Replaceable insert	122
GM/GML	Movement joints profiles	Jointec	Structural modular	117
GMP/GMLP	Movement joints profiles	Jointec	Perimeter modular	121
GR/GRL	Movement joints profiles	Jointec	Structural	116
GRM	Movement joints profiles	Jointec	Structural	116
GS	Movement joints profiles	Jointec	Seismic expansion joint	120
GT	Movement joints profiles	Jointec	Control joints	123

Code	Family	Product	Use	Pag.
IC	Baseboards and wall protection rails	Sanitec	Hygienic	156
IC	Wall covering profiles	Sanitec	Internal cover	103
IJ	Wall covering profiles	InterJolly	Internal corner	103
K	Drainage systems	Profile Drain	Drainage profiles	173
KV/KPV	Drainage systems	Profile Drain	Sloping profiles	173
KJ-P	Wall covering profiles	KeraJolly	Co-extruded cove	84
KJ	Wall covering profiles	KeraJolly	Finish	84
LEB	Profili LED	LED	LED	104
LEL	Profili LED	LED	LED	104
LEM	Profili LED	LED	LED	104
LES	Profili LED	LED	LED	61
LEV	Tile installation accessories	Leveltec	Levelling system	182
LG/LS	Floor covering profiles	Woodtec	Decorative	38
LI 10	Wall covering profiles	Listec	Glitter decorative	91
LI 10 glitter	Wall covering profiles	Listec	Decorative	91
LI 15	Wall covering profiles	Listec	Glitter decorative	91
LI 15 glitter	Wall covering profiles	Listec	Decorative	91
LI 20-22	Wall covering profiles	Listec	Decorative mosaic	91
LIA	Wall covering profiles	Listelli	Decorative mosaic	93
LIM 44	Wall covering profiles	Mosaitect	Decorative mosaic	90
LIM 51	Wall covering profiles	Mosaitect	Wood end cap	90
LP	Floor covering profiles	Woodtec	Compensating edge	38
LT	Floor covering profiles	Woodtec	Wood end cap	37
MAG	Tile installation accessories	Magtec	Magnetic access panels	191
MA	Floor covering profiles	Carpetec	End cap moquettes	39
MS/MD	Floor covering profiles	Carpetec	End cap moquettes	40
MB	Floor covering profiles	Linetec	Separation	20
MG	Floor covering profiles	Carpetec	Carpet joint	39
MP	Floor covering profiles	Carpetec	Transition	39
MUD	Drainage systems	Multidrain	Surface outdoor drainage	174
MUDR	Drainage systems	Multidrain	Surface outdoor drainage	174
MulticlipLVT	Floor covering profiles	Multiclip	multiclip LVT	33
Multiclip	Floor covering profiles	Multiclip	multiclip	30
multicover	Floor covering profiles	Multicover	Wood	36
Multifix	Floor covering profiles	Multiclip	multiclip-multifix	35
PD	Drainage systems	Copridrain	Drain grate	172
PQ	Floor covering profiles	Linetec	Junction	29

Code	Family	Product	Use	Pag.
PR	Floor covering profiles	Linetec	Junction	29
PS	Tile installation accessories	Pesotec		191
PS130	Baseboards and wall protection rails	Plano	Drywall	155
PT	Floor covering profiles	Linetec	Separation	20
PU	Floor covering profiles	Linetec	Junction	29
RD	Floor covering profiles	Roundtec	Transition	12
RD	Stair nosing profiles	Serie	Rounded	49
RE	Wall covering profiles	RoundCorner	Corner joint	99
RJ	Floor covering profiles	Roundjolly	Thin-Set	12
RJ	Wall covering profiles	RoundJolly®	Junction	73
RJ	Stair nosing profiles	RoundJolly®	Thin-set	50
RJ - SJM	Stair nosing profiles	RJ - SJM		54
RJE	Wall covering profiles	RoundJolly®	Finishing	81
RJF	Wall covering profiles	Filojolly	Invisible	81
RJF	Stair nosing profiles	Filojolly	invisible junction. mosaic	47
RJM	Wall covering profiles	Mosaitect	Mosaic	88
RJS	Stair nosing profiles	RoundJolly®	Junction	81
RJ-RD	Stair nosing profiles	Serie		49
RO	Wall covering profiles	RoundCorner	Corner guard	95
RP	Floor covering profiles	Leveltec	Transition	26
RPR	Floor covering profiles	Leveltec	Transition	26
RS-IL	Wall covering profiles	Sanitec	Internal cove	97
SA	Stair nosing profiles	Stairtec	Non-slip edge	57
SB	Wall covering profiles	Sanitec	Internal cove	99
SB10	Wall covering profiles	Sanitec	Junction	100
SB15-IL	Wall covering profiles	Sanitec	Junction	99
SB20/SB24	Wall covering profiles	Sanitec	Junction for bathub, shower trays	100/101
SB12/SB18	Wall covering profiles	Sanitec	Methacr. for bathub, shower trays	99/101
SB30	Wall covering profiles	Sanitec	Multipurpose junction	101
SC	Stair nosing profiles	Stairtec	Vynil floors	59
SD	Drainage systems	Square Drain	Square	172
SE	Stair nosing profiles	Stairtec	Ribbed edge	57
SET80*	Tile installation accessories	SET	Floating floors	187
SI	Stair nosing profiles	Stairtec	Floating floors	56
SJ	Floor covering profiles	Squarejolly	Stainless steel	13
SJ	Wall covering profiles	Squarejolly	Joint	66
SJ	Stair nosing profiles	Squarejolly	Multi-purpose	52

Code	Family	Product	Use	Pag.
SJM	Floor covering profiles	Mosaitect	Square for ceramic	12
SJM	Wall covering profiles	Mosaitect	Thin-Set	88
SJQ	Wall covering profiles	Squarejolly	Decorative	94
SJR	Stair nosing profiles	Squarejolly	Square with Resin Grip	54
SL	Stair nosing profiles	Stairtec	Retrofit	58
SM	Stair nosing profiles	Stairtec	Shower Tray	59
SP	Floor covering profiles	Coverttec	Joint	21
SR	Floor covering profiles	Trimtec	Trim	9
SR	Stair nosing profiles	Stairtec	Metal for ceramic tiles	47
ST	Floor covering profiles	Striptec	Threshold	22
STB/STP	Floor covering profiles	Striptec	Existing floors	25
STC	Floor covering profiles	Coprifilo		42
STL	Drainage systems	Showertec Linear	Linear drainage Shower	160
SUPA	Tile installation accessories	Support	Supports self leveling head	186
SUPA	Perimeter profiles for balconies	Support	Supports self leveling head	139
SUPT	Tile installation accessories	Support	adjustable	187
SVT	Stair nosing profiles	Stairtec	technical for LVT	48
SW	Stair nosing profiles	Stairtec	Non-slip strip	55
SWH	Stair nosing profiles	Walktec	Non-slip strip	56
SWP	Stair nosing profiles	Stairtec	Stainless steel button	55
SWR	Stair nosing profiles	Stairtec	Non-slip button	55
TJ	Wall covering profiles	Trialjolly	Edge	94
TR	Wall covering profiles	Kerajolly	Finish	83
TR	Floor covering profiles	Trimtec	Multipurpose	6
TR	Stair nosing profiles	Trimtec	Multipurpose	44
TTR/TTO	Stair nosing profiles	Tubo	Stair carpets	62
Variotec	Floor covering profiles	Variotec	Transition	29
WA	Wall covering profiles	Wallprotection	Corner guard	96
WB	Baseboards and wall protection rails	Wallprotection	Hygienic	157
WP	Wall covering profiles	Wallprotection	Wall rail	96
ZP	Floor covering profiles	Leveltec	Junction	28
ZR	Floor covering profiles	Zerotec	Transition	18
ZR60	Floor covering profiles	Zerotec	Transition	17
ZRM	Floor covering profiles	Zerotec	Transition	17
ZRN60	Floor covering profiles	Zerotec	Transition	16
ZRR	Floor covering profiles	Ramptec	Transition	19

Plastic

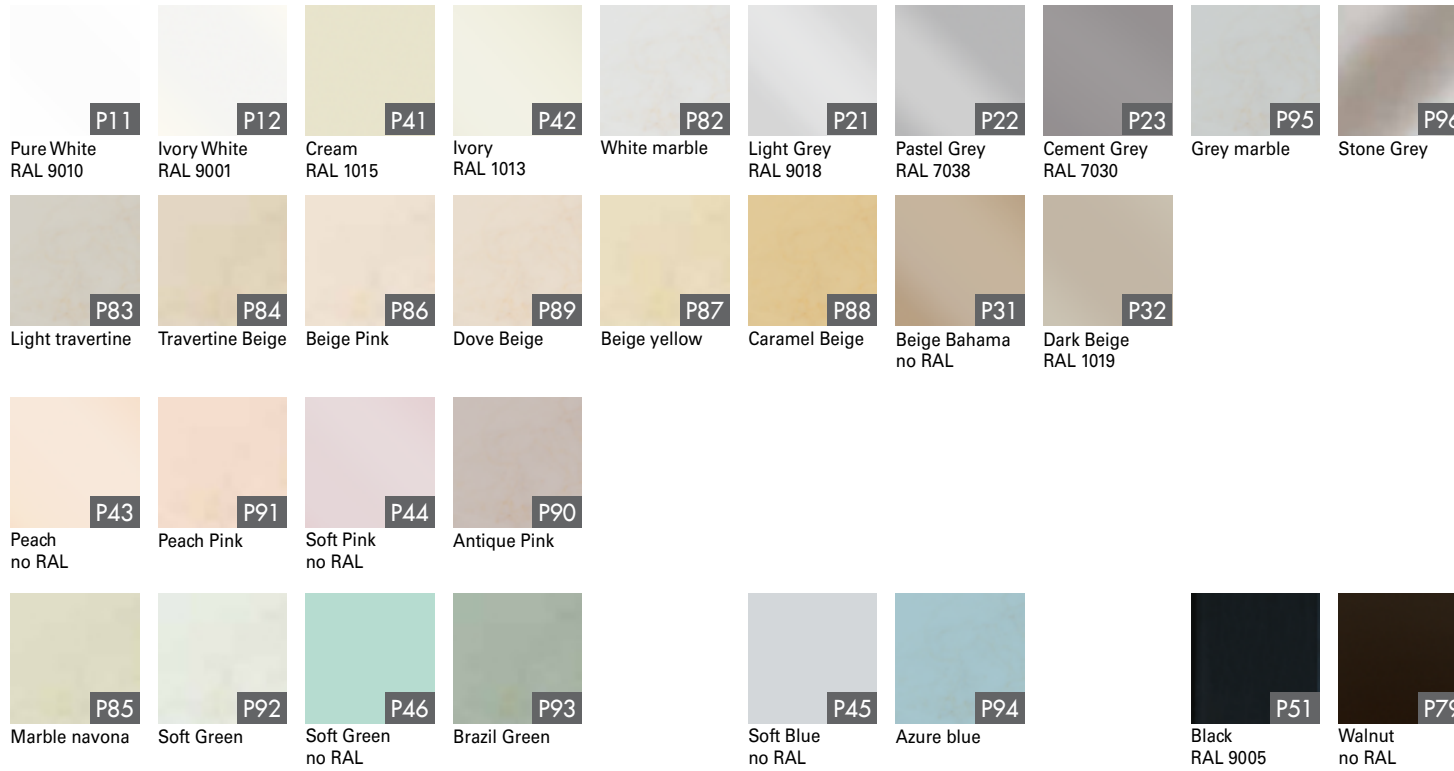



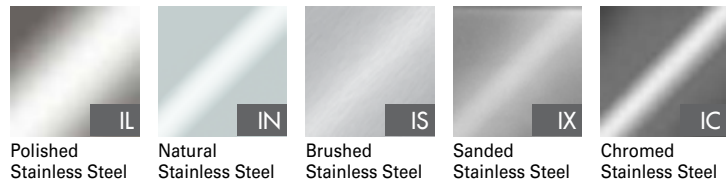



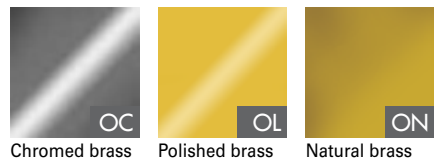



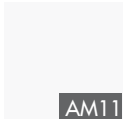

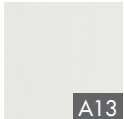
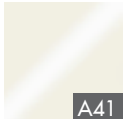
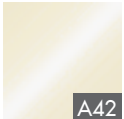

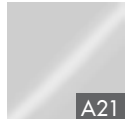

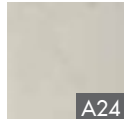
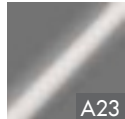
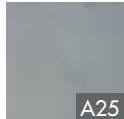
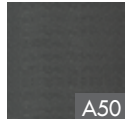
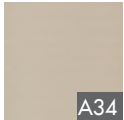
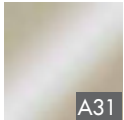
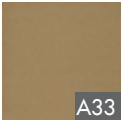

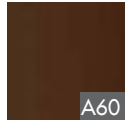
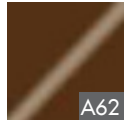
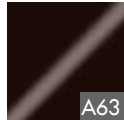
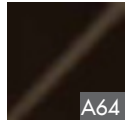
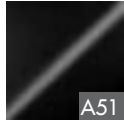
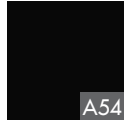
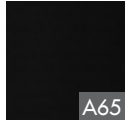



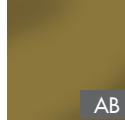
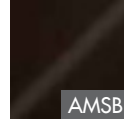

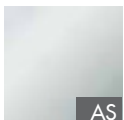
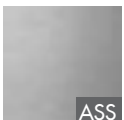



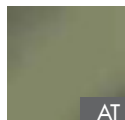

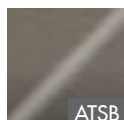
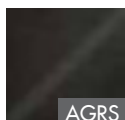
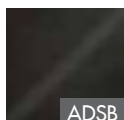
Stainless Steel





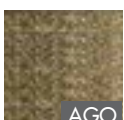



Brass

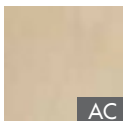
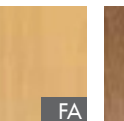
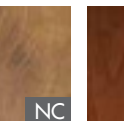
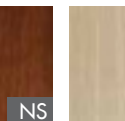
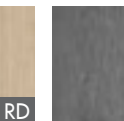
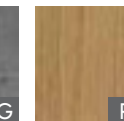

Aluminium

 Pure White RAL 9010 A11	 Matt White AM11	 Ivory White RAL 9001 A12	 Rustic White no RAL A13	 Cream RAL 1015 A41	 Ivory RAL 1013 A42	 Soft Pink no RAL A44	 Light Grey RAL 9018 A21	 Pastel Grey RAL 7038 A22	 Embossed pastel Grey A24	 Cement Grey RAL 7030 A23	 Embossed Cement Grey A25	 Micaeous Grey no RAL A50
 Embossed Kaki A34	 Beige Bahama no RAL A31	 Embossed dove A33	 Dark Beige RAL 1019 A32	 Corten no RAL A60	 Red brown no RAL A62	 Dark brown no RAL A63	 Embossed Dark brown A64	 Black RAL 9005 A51	 Matt Black A54	 Embossed matt Black A65		
 Aluminum copper AR	 Bright polished Aluminum copper ARB	 Bright polished brushed aluminium copper ARSB	 Bright Polished Sanded aluminium champagne ACXB	 Aluminum bronze AB	 Brushed Anodized aluminium antique bronze AMSB							
 Natural aluminium AN	 Silver aluminium AS	 Brushed silver aluminium ASS	 Brushed bright polished silver aluminium ASSB	 Bright polished Chrome ASB	 Sanded bright polished silver aluminium ASXB	 Grinded Bright Polished silver aluminium ASGB	 Aluminum titanium AT	 Bright polished copper aluminium ATB	 Bright polished brushed titanium aluminium ATSB	 Brushed graphite aluminium AGRS	 Bright polished brushed black aluminium ADSB	
 Gold aluminium AO	 Bright polished gold Aluminium AOB	 Bright polished brushed gold aluminium AOSB	 Bright polished pink Gold aluminium AORB									
 Glitter Carbon aluminium AGC	 Glitter Gold aluminium AGO	 Glitter Silver aluminium AGS	 Glitter Soft Bronze aluminium AGSB	 Glitter Soft Anthracite aluminium AGSM	 Glitter Soft Silver aluminium AGSS							

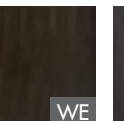
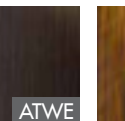
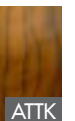

Wood / texture

 Marple AC	 Cherry CI	 Beechwood FA	 Light walnut NC	 Dark walnut NS	 Decapé oak RD	 Grey oak RG	 Oak RO	 Aluminum oak texture ATRO	 Bleached RS	 Aluminum White- ned oak texture ATRS	 Wengé oak RW	 Wengé WE	 Aluminum wengé texture ATWE	 Aluminum teak texture ATTK
---	---	--	---	--	---	---	--	--	---	---	--	--	--	---

Code Key:

 **SELFLINE/PRE-CUT** 0.90 and 1.35 m / 3'-9/16" and 4'-5"
Ceramic line with EAN bar code without individual packaging

 **SELFLINE-A and SELFLINE-N/KIT PRE-CUT**
0.90 and 1.35 m / 3'-9/16" and 4'-5"
Individual PET packaging with EAN bar code

 **SELFLINE-F/KIT PRE-CUT**
 5+5 x 0.90m / 3/16" + 3/16" x 3'-9/16"
 7 + 7 x 1.35 m / 9/32" + 9/32" x 4'-5"
Individual packaging with screws and dowels

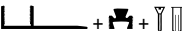
 **SELFLINE/KIT PRE-CUT MULTICLIP**
0.90 and 1.35 m / 3'-9/16" and 4'-5"

Individual packaging + base, clip screws and dowels

 **SELFLINE-T/KIT PRE-CUT MULTIFIX 6 pcs/m**
0.90 and 1.35 m / 3'-9/16" and 4'-5"
Individual packaging with 6 dowels/meter

 **CURVELINE/FORMABLE Code D**
AND + \$ / pc OND + \$ / pc
ASD + \$ / pc ILD + \$ / pc
Version with fomable flange

10% price surcharge for profiles cut to length with off-cuts at charge.
"N" articles in the drilled version (holes every 18cm / 7-3/32")
All the drilled articles "F" in 2.70m / 8'10" length can be supplied not drilled "N" at the same price.

■ Standard box

 Individually wrapped

new = new article

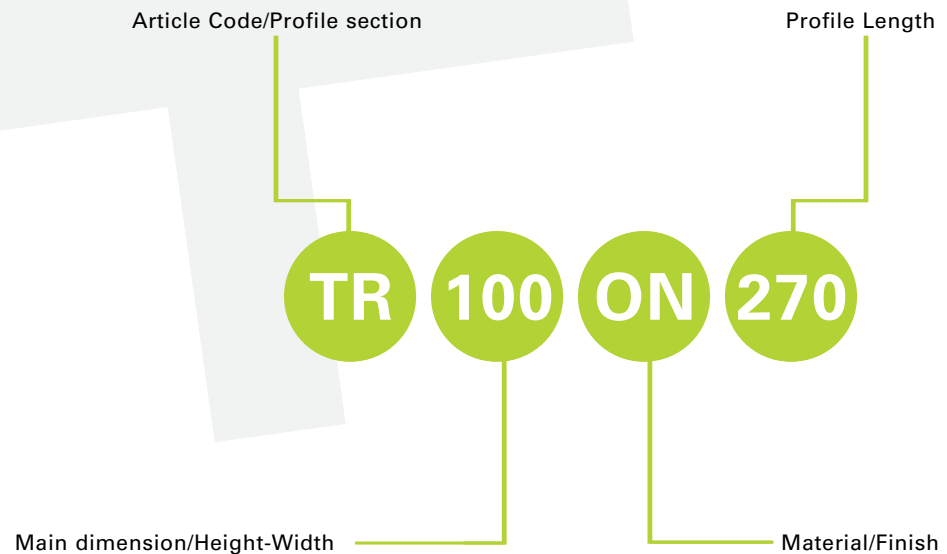

Terms and Conditions of Sale:

All prior conditions of sale shall be deemed to be modified as hereinafter stated and the following conditions shall be deemed to supersede and control disputes or claims to goods.

PRICES AND QUOTATIONS

The prices shown in the Price List exclude installation, delivery, and any federal, state or city tax now or hereafter applicable to sale of products of Profilitec illustrated in this Price List. Prices quoted in this Price List apply to orders made thereunder and with respect to the products therein described. Prices set out in this Price List are subject to change without prior notice. Prices include ground freight charges within the continental USA, save and except for purchase orders under \$3,000 gross value to which a \$38 additional charge, and below \$200 gross value a \$48 additional charge, shall be added thereto. Please note that certain items which exceed standard shipping dimensions are not eligible for express handling. Please note that we are unable to accommodate 3rd party transport billing. Minimum Order Requirements: Uptec and Leveltec minimum order quantity is 6 boxes each.

OWNERSHIP OF THE PROPERTY:

Ownership of the products shall remain and vest with Profilitec until full payment has been received with respect thereto.

DELIVERY AND HANDLING

If Profilitec is prevented from carrying out the provisions hereof by reason of any acts constituting "force majeure" or any other event beyond its control, interfering with the production or delivery of the products as herein contemplated, Profilitec shall be exonerated from and shall not be liable for any loss or damage arising from any of the foregoing and shall be further excused from making deliveries and shall have, in addition to the foregoing and without prejudice thereto, the absolute right to cancel any purchase orders with respect to any of the products therein described or with respect to any part thereof without incurring any liability of any nature whatsoever other than the obligation to reimburse and return any payments of monies made in advance for the products which shall not be delivered for the reasons hereinabove set forth. Any delivery not in dispute shall be paid for regardless of any other existing disputes between Profilitec and the Buyer relating to other delivered or undelivered products.

INSPECTION AND SAMPLE

The Buyer shall have the right to inspect the products upon delivery of same. Failure by the Buyer to inspect the said products and specify in writing to Profilitec any defective products shall constitute on the Buyer's part an absolute and unconditional waiver of the Buyer's right to reject the products and shall be deemed an acceptance by the Buyer of the products as to quality and/or quantity of same. Any samples of the products shown to the Buyer prior to placement of any order with Profilitec are for the sole purpose and intent of exhibiting to the Buyer the type of products which may be the subject matter of an order by the Buyer. Such samples create no warranty on the part of Profilitec, implied or otherwise, that the said products ultimately forming

the subject matter of an order placed by the Buyer necessarily shall conform with the samples referred to above.

CLAIMS

Any claim for damage, short shipment, misdelivery or defects of the products must be specified in writing and brought to the attention of Profilitec at the time of delivery. If no claim is made by the Buyer at the time of receipt of the products, then the right to make such claim or the right to reject any or all of the products shall be waived by the Buyer. At its option, Profilitec will either replace such products that are proven defective or allow credit for them.

INSTALLATION

Profilitec shall in no way be responsible for any claims resulting from the installation or assembly of the products.

LIABILITY

Profilitec is not liable and/or responsible toward any third party and/or Buyer, as the case may be, for any damage and/or loss of any nature resulting directly or indirectly from the use of the products in a manner not in conformity with the instructions accompanying same and in effect with respect thereto and/or resulting from the products being improperly. Prior to any use of products, the user and/or Buyer has the prior obligation to verify the suitability of the products for their intended use and the Buyer shall assume all risks and responsibility with respect thereto.

Profilitec's responsibility and liability with respect to defective products and/or work attaching thereto shall be confined solely to the replacement and/or repair of same. In addition to the foregoing, Profilitec shall alternatively have the right to reimburse the Buyer the purchase price paid with respect thereto rather than to replace and/or repair the defective products.

TERMS OF PAYMENT FOR ESTABLISHED ACCOUNTS

Net 30 days from the invoice date. All past due invoices are subject to a 1.5% service charge per month (18% per year). Upon failure by the Buyer to pay for the products, the Buyer shall be obliged to pay all costs of collection incurred by Profilitec including, without limitation, collection agency fees, statutory costs, disbursements, legal fees in an amount not in excess of but equal to 25% of the unpaid balance of the purchase price at the time of the referral of same by Profilitec to a collection agency, attorney, etc.

RETURNS

Profilitec shall not accept any returns unless it authorizes same in writing. In any event, Profilitec under no circumstances shall accept any returned products 30 days from the invoice date of same. All products returned must be in perfect condition and are subject to inspection by Profilitec prior to acceptance of same. Any returns which have not been authorized by Profilitec in advance may be refused; however, if Profilitec accepts the return, a handling charge of 25% will be charged. No returns will be accepted or allowed on any special orders.

ACCEPTANCE

Installation and/or use of the products by the Buyer shall constitute an irrevocable acceptance of the products. Failure to reject the products in the manner and within the time period stipulated in paragraphs 4 and 5 hereof shall be deemed to constitute an acceptance of the products.

CANCELLATION

Orders are not subject to cancellation or deferment of shipment unless Profilitec is indemnified against the loss resulting therefrom. Profilitec shall not be responsible for delays or non performance caused by strikes, fires or other causes beyond its control, as the whole is stipulated in paragraph 3 hereof. Orders entered on Profilitec's order book cannot be cancelled or changed without Profilitec's prior written consent and only on the terms which will indemnify Profilitec against all loss. Orders issued a tracking number are considered shipped, and cancellation will incur a 25% restocking fee. At no time shall Profilitec accept the cancellation and/or change of a special order.

SPECIAL ORDERS

The Buyer will defend, at its own expense, any suit which may be brought against Profilitec by reason of the manufacture or sale of special products made to the Buyer's specifications, including any third party proceedings.

MODIFICATIONS OF CONDITIONS

No modifications of the conditions can be made without the prior written authorization from a representative of Profilitec.

Claims:

Any claims must be written, properly motivated and approved in advance by Profilitec Spa.
Whether or not to accept the request is always at the discretion of Profilitec spa.
Except for any exceptions previously agreed, any claims will be made as follows:

- Returns can be accepted within 30 days from receipt of the goods;
- Any returns for undamaged goods will be reduced by 20% of its initial value;
- The return must be followed by a contextual order for a net amount equal to or greater than the value of the return;
- Fixed administrative management costs of € 30.00, will be charged;
- Any transport costs will be at the charge of the customer according to methods and conditions defined and according to the specific case;
- The goods must be suitably packaged to ensure a safe transport. It must be received by Profilitec undamaged, complete with the original boxes (if available) and with all the related accessories. The control of the returned goods will be done at the discretion of the competent office in charge. Should the returned goods be defective, not suitable, incomplete or in non-optimal conditions due to a failure to follow the above mentioned instructions, the reduction may be greater than 20% or deemed invalid.

ALL RIGHTS ARE RESERVED

It is forbidden even partial reproduction of text, photographs and illustrations contained in this price list without written authorization of Profilitec Corp.

Price List Profilitec S.p.A - Code LIST22/EN

Edited March 2022 - Revision DIR./00.

Valid from April 1st

Distribution not controlled.

Copyright by Profilitec S.p.A. 36033 Isola Vicentina (VI) Italy





Profilitec SpA
Via Scotte, 3
36033 - Isola Vicentina
(Vicenza) ITALY
www.profilitec.com

Contacts:
tel: +39 0444 268311
fax: +39 0444 268319
e-mail: export@profilitec.com (EXP)
e-mail: profilitec@profilitec.com (IT)



- + FLOOR COVERING PROFILES
- + STAIR NOSING PROFILES
- + WALL COVERING PROFILES
- + MOVEMENT JOINT PROFILES
- + PERIMETER PROFILES FOR BALCONIES AND TERRACES
- + TILE INSTALLATION MEMBRANES
- + BASEBOARDS AND WALL PROTECTION RAILS
- + DRAINAGE SYSTEMS
- + DIY PROFILES
- + TILE INSTALLATION ACCESSORIES

Price List Profilitec S.p.A. - Code LIST21/EN
Draft March 2021 - Revision DIR./00
Valid from April 1st
Distribution not controlled.